

VACUUM SYSTEM OF SESAME STORAGE RING

M. Al-Najdawi, E. Huttel, F. Makahleh, M. Shehab, H. Al-Mohammad

SESAME Light Source, P.O. Box 7, Allan 19252, Jordan

Abstract

SESAME (Synchrotron-light for Experimental Science and Applications in the Middle East) is a third-generation synchrotron light source under construction near Amman (Jordan). The storage ring has 16 Dipole arc chambers, 8 short and 8 long straight chambers. The general layout and detailed design of the vacuum chambers, crotch absorbers, RF bellows, injection and RF sections will be presented in this contribution, also the testing of the chambers prototype, bake out process and final installation.

STORAGE RING VACUUM SYSTEM

The storage ring is divided into 16 cells, each cell contains a dipole arc chamber and a straight chamber (long or short) closed by UHV RF shielded gate valve.

There are two types of the vacuum cells, an arc chamber with long straight with a total length of 9.35m and an arc chamber with short straight with a total length of 7.3 m. The overall length is 133.2 m. Lumped absorbers are used to absorb the unwanted synchrotron radiation (SR), there are four types of the absorbers based on the location they are installed.

Diode sputter ion pumps (SIP) are installed near the absorbers with an overall nominal pumping speed of 20500 l/s, also, a NEG pumps are installed near the absorber with the highest SR absorption (higher outgassing)

Valves are installed upstream and downstream of each long straight, 16 in total.

Bellows are installed upstream and downstream of each short and long straight and upstream and in addition up and downstream of the septum.

Inverted magnetron Gauges are installed one at each dipole and each long straight chamber, whereas in the RF section at each of the four cavities

Figure 1 shows the general storage ring vacuum layout and a list of the installed pumps.

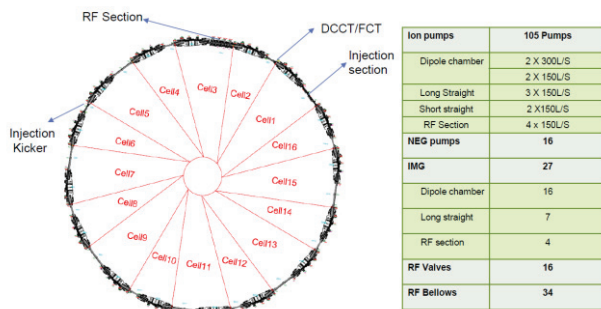

Figure 1: General storage ring vacuum layout.

Crotch Absorber Design

The crotch absorber design follows the same design implemented for the ANKA and SLS [1] light sources, it consist of two parts with 8.8° vertical tooth inclination and 5° horizontal tooth angle and 10mm tooth width. The thermal load has been applied in a conservative way such that the maximum power intensity on each teeth of the absorber has been applied on the whole subjected area the FWHM Area.

FEA analyses for all absorber have been done for a 2.5 GeV 400 mA e-beam; corresponding to 240 kW SR Power. The most critical absorber 2 with the tip located at 641 mm from the source point is exposed to a surface power density of 45.8 W/mm². At this location the maximum stress is 175 MPa, the maximum strain is 0.15% and the maximum temperature is 300 °C. Figure 2 shows the FEA results for absorber 2 and Table 1 lists the parameter for all absorbers.

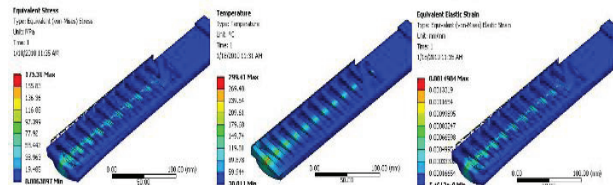

Figure 2: FEA results for absorber 2.

Table 1: Parameter of the SR Absorber

Abs.	Angle [°]	Power [kW]	Lin.Pow. Density [W/mm]	Temp. Max [°C]	Strain [%]
1	6	4.1	41	192	0.14
2	11	7.5	58	300	0.14
3	5	3.2	25	142	0.04
4	0.5	0.4	11	75	0.01

RF Shielded Bellows

The RF bellow design is similar to SLS and ALBA design with some modifications, the bellow has a compact design with a free length of 115 mm and has a sleeve made of 316L stainless steel sheet and 19 fingers made of beryllium copper sheets (0.4 mm thickness). The bellow has a cover made of aluminium; the benefit from the cover is to limit the compression and expansion of the bellow (15mm compression, 3mm expansion and ±2 mm in all transvers directions) also to protect the bellow body from any damage. Figure 3 shows the design concept of the bellow.

Content from this work may be used under the terms of the CC BY 3.0 licence (© 2016). Any distribution of this work must maintain attribution to the author(s), title of the work, publisher, and DOI.

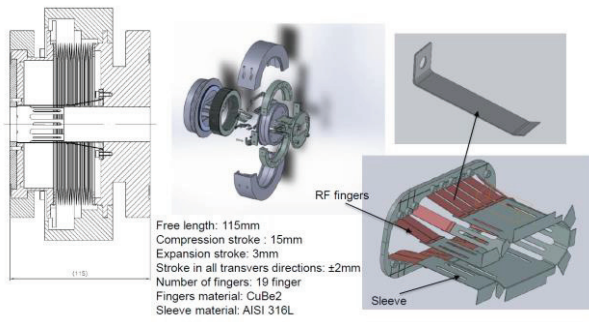

Figure 3: RF bellow design.

Special Straight Sections

There are three special straight sections in the storage ring, the injection, RF and kicker sections. The injection section consists of the injection septum; which has an internal thin walled stainless steel pipe for the incoming beam and pipe made of mild steel for the stored beam. There will be a horizontal fluorescent screen with a motorized linear actuator to monitor the injected and stored beam, a Bunch by bunch feedback kicker and a vertical scraper are also installed in the same section. Figure 4 shows the layout of the injection section.

The second special section is the RF section. Four cavities (Elettra cavity design) will be installed in this section with a downstream and upstream transition parts to have a smooth transition from the key shape arc chamber to the cavity circular shape tube. Between the cavities there will be transition tubes with absorbers and RF shielded bellows at both ends. Figure 5 shows the layout of the RF section, Absorber and the upstream transition parts.

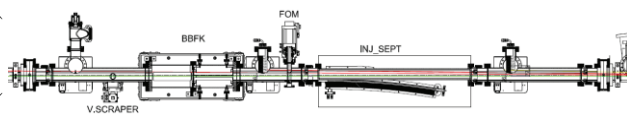

Figure 4: Injection section layout.

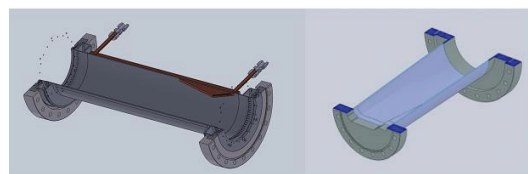
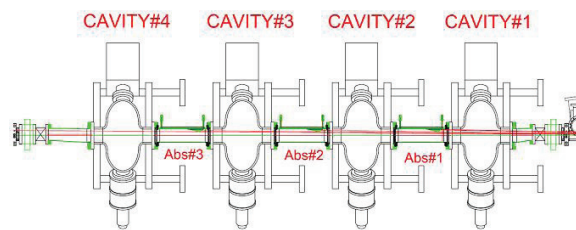

Figure 5: RF section layout, transition centre absorber and the upstream transition parts.

Vacuum Pressure Simulation

To simulate and calculate the vacuum pressure profile in the storage ring, we have used a coupled simulation using SynRad+ [2] to simulate the beam and Molflow [3] to

calculate and simulate the vacuum pressure profile. The simulation started by having a simplified model for the internal volume of the chamber and having an empty block for the absorbers. After defining the beam parameters, the simulation started and an outgassing map will be generated for each absorber where the beam hit. Figure 6 shows SynRad+ simulation and the generated outgassing map. After exporting these maps to Molflow we defined the pumps sizes and starting the simulation. Three different vacuum simulations were performed for the most desorbed gases (H₂, CO and CO₂) and taking advantage of the linear behaviour of the ultra-high vacuum systems, the partial pressure were summed at the end. Figure 7 shows the pressure profile for a complete sector (two arc chambers with a short straight section) at first injection, after 100Ah with nominal current 100 mA, after 500 Ah 300 mA and after 1000Ah 400 mA.

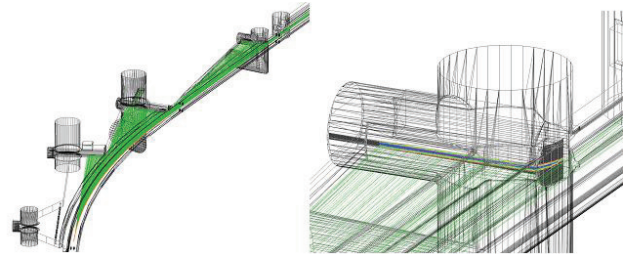

Figure 6: SynRad+ simulation model.

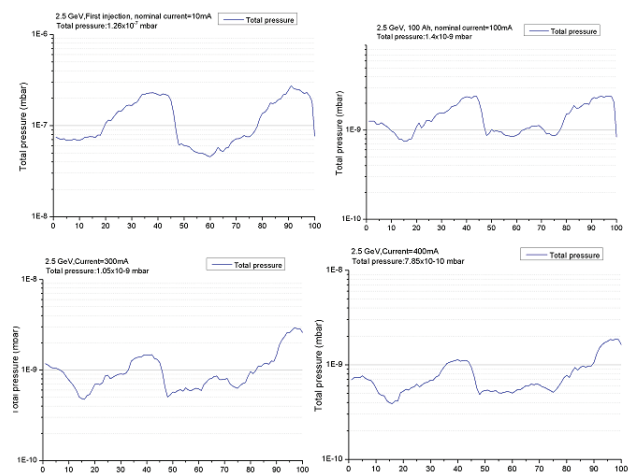

Figure 7: The pressure profile at first injection, after 100Ah 100 mA, 500 Ah 300 mA and after 1000Ah 400 mA.

THE STORAGE RING VACUUM SYSTEM INSTALLATION

The prototype chamber was installed and tested with all magnets and girder at CERN in March 2015 and the real installation of the series vacuum chambers started in February 2016.

The installation started by mounting the arc chamber on a test girder and all vacuum components, gauges, valves were installed, then a roughing pump station were connected to the chamber and pumped down, after that a

helium leak detector had been connected to the system and a leak check was performed. After the leak check and our leak rate target 1×10^{-10} mbar l/s achieved, the chamber was moved to the bake out oven using a skeleton, another leak check and an RGA scan was performed.

The bake out process started at room and the temperature gradually increasing by $25 \text{ }^\circ\text{C/h}$ up to $200 \text{ }^\circ\text{C}$ for 72 hours. During the cooldown at $150 \text{ }^\circ\text{C}$ the ion pumps were flushed many times. After the complete cool down a leak check and an RGA scan were performed using secondary electron multiplier (SEM) for higher accuracy results.

After all tests the chamber was moved under vacuum to the storage ring tunnel for final installation.

The long straight chamber were installed and connected to the arc chamber by the RF bellows, a leak check has been done then an in-situ bake out performed at $200 \text{ }^\circ\text{C}$ for 72 hours, after finishing the bake out process, another leak check was performed.

While the 16 RF gate valves are located up and down stream of the long straight section only; the short straights are connected directly to the arc chambers without gate valves. First, the short straight had been installed in the ring without connecting. Then bake out had been performed and after cool down to room temperature the short straight, the downstream and upstream arc chambers were vented by nitrogen, then the RF bellows installed and the whole assembly pumped down again, ion pumps turned on and the NEG pumps were activated.

Figure 8 shows some pictures of the assembly of the storage ring vacuum system and Figure 9 shows a flow chart of the assembly and bake-out procedure being followed for the storage ring vacuum system installation.



Source of photos © SESAME.

Figure 8: A photos during the assembly, bake-out and installation of the storage ring vacuum chambers.

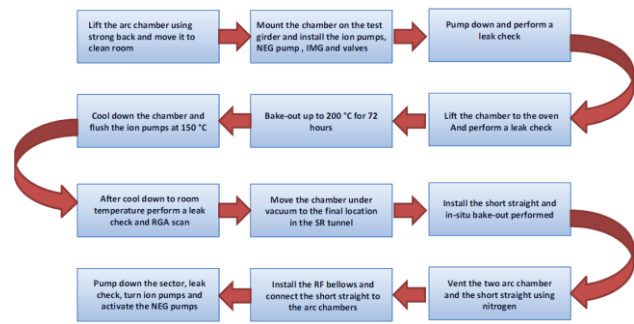

Figure 9: The flow chart of the assembly, bake-out and installation procedure.

ACKNOWLEDGEMENT

The author would like to thank SESAME installation team, especially the vacuum team for all the effort and hard work they give during the installation of the vacuum system.

REFERENCES

- [1] S.Hermle, E.Huttel, D.Einfeld,G.Heidenreich, Layout of the Absorbers for ANKA.
- [2] R. Kersevan (1993), SYNRAD, a Monte Carlo synchrotron radiation ray-tracing program, Proceedings of the 1993. Particle Accelerator Conference, vol.5, p 3848-3850.
- [3] R. Kersevan, J-L Pons (2009), "Introduction to Mol-flow+", JVST A27 (2009), p1017-10.