

Content from this work may be used under the terms of the CC BY 3.0 licence (© 2016). Any distribution of this work must maintain attribution to the author(s), title of the work, publisher, and DOI.

PRELIMINARY ACTIVE VIBRATION ELIMINATION STUDY OF THE TPS GIRDER SYSTEM

T.C. Tseng, S.Y. Perng, H.S. Wang, K.H. Hsu, W.Y. Lai, M.L. Chen, H.C. Ho, C.J. Lin, D.G. Huang, C.W. Tsai, C.K. Kuan, National Synchrotron Radiation Research Center, Hsinchu, Taiwan

Abstract

Taiwan Photon Source (TPS) had delivered the first synchrotron light on the last day of 2014 and is to open to the users from September 2016 after one and half years of commissioning and insertion devices installation. However, the instability is still an obvious problem to the beam quality and the deviation amplification factor of the magnets to the electron beam plays an important contribution role. Since the magnets are firmly installed on the girders and the contribution is mainly transferred from the girder vibration. This study tries to eliminate the obvious vibration frequencies amplitude exerted on the girder from outside sources such as the utility system with the PZT actuators installed on the locking wedges between girder and pedestals. By the amplitude and inverse phase searching iteration, some vibration frequency peaks in phase domain can be eliminated and the instability is also reduced.

INTRODUCTION

The Taiwan Photon Source (TPS) storage ring began the installation at Oct. 2013 as shown in the Figure 1 and had delivered the first synchrotron light on the last day of 2014[1]. After one and half years of commissioning and insertion devices installation, TPS is scheduled to open to the users from September 2016.

However, the instability is still an obvious problem to the beam quality and the deviation amplification factor of the magnets to the electron beam plays an important contribution role[2]. Since the magnets are firmly installed on the girders and the contribution is mainly transferred from the girder vibration.

In order to align the girders precisely and quickly with less manpower, an automatic-tuning girder system was proposed and fulfilled[3,4,5]. This girder system showed prominent adjustability and stability[6]. However, due to the heavy load of magnets the natural frequency as showed in Figure 2 is still not high enough although a locking system has applied. From the vibration spectrum inspection on the girder set and ground, there are frequency peaks other than the natural frequencies from outside sources such as the utility system as shown in the Figure 3.

This preliminary study tries to show the ability to eliminate the obvious vibration frequencies amplitude exerted on the girder system from outside sources. And eventually an active system will be set up to improve the stability.



Figure 1: TPS Storage ring bending section.

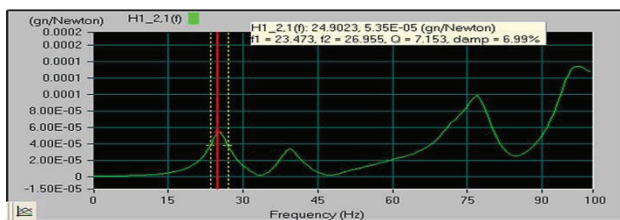

Figure 2: Natural frequency of one girder set with locking system.

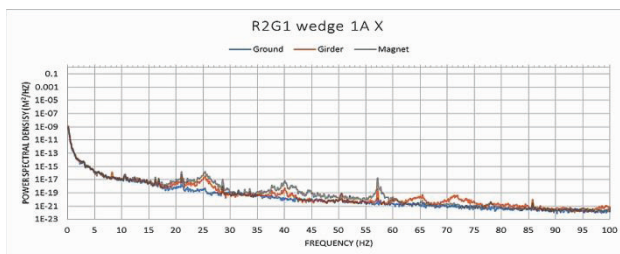

Figure 3: Vibration spectrum measurement around a girder set.

TESTING GIRDER SETUP

An extra testing girder set had been installed at the TPS inner ring lab for the preliminary study instead of the storage girder for convenient. The TPS storage ring girder configuration is shown as in Figure 4. Two modified locking wedges with PZT modular as in Figure 5 are installed at the same side of outside two pedestals as the anti-vibration actuators.

Two 3-axes PCB 356B18 accelerometers are placed on the girder surface top of the outside pedestals. These accelerometers serve as the monitors at the preliminary study stage and will be the feedback sensors for the active system.

A computer with labview program was prepared to control the system. The accelerometer signals are received

through an ADLINK PXIe-9529 interface card. And a shaker with function generator output exerted on the girder body to simulated the vibration source as in Figure 6. A Tektronix AFG3022C function generator with 2 output channels to driving the PZT to compensate the vibration derived form the shaker. The AFG3022C will be replaced with an ADLINK PXI-2502 DAQ card for the active system.



Figure 6: A shaker to simulate the vibration source.

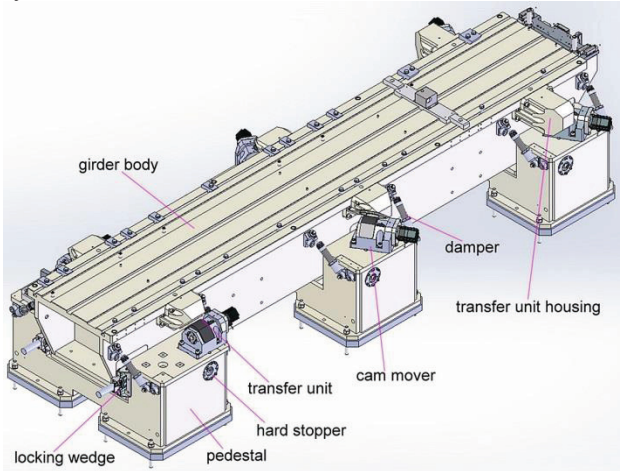

Figure 4: TPS girder configuration.

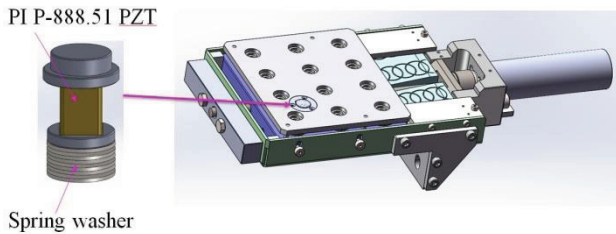

Figure 5: Modified locking wedge with PZT modular.

TESTING RESULTS

As shown in Figure 7, by using the function generator to control the shaker, a 27 Hz vibration peak can be detected from the accelerometer in the horizontal transverse direction of one side. The other directions and the accelerometer on the other side are negligible. This result shows the stability of the girder is still quite good. By adjusting the amplitude and phase output of the AFG3022C as shown in Figure 9, the 27Hz peak generated from the shaker can be eliminated as shown in Figure 8.

However, the peaks of 45Hz and 52Hz, the natural frequencies of the girder without magnets installed, cannot be eliminated because they are aroused from the environment white noise without steady phase.

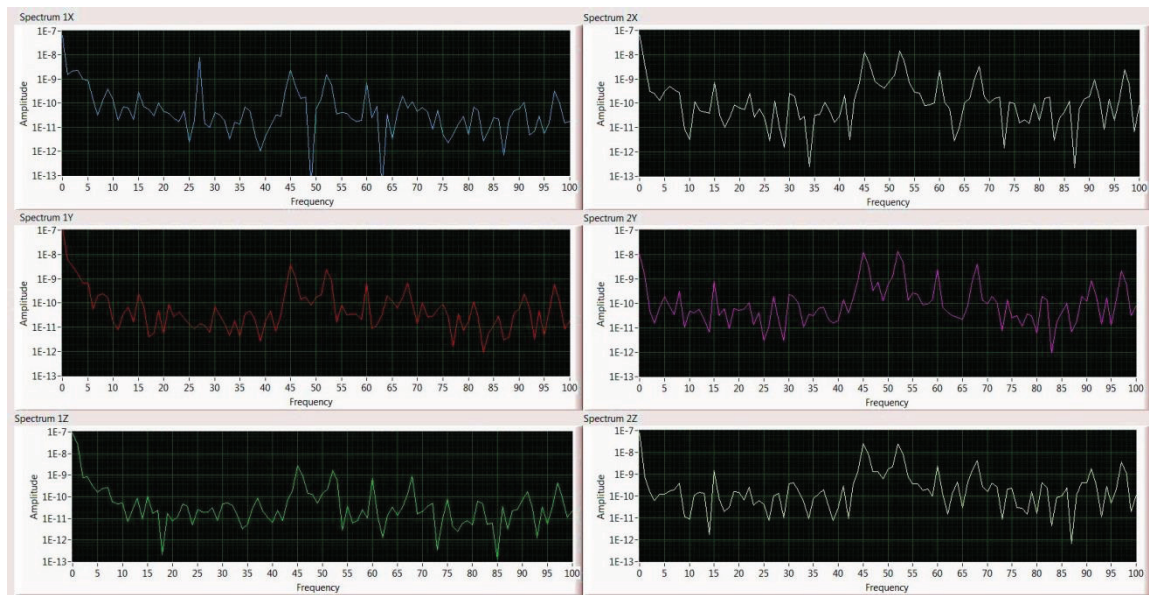

Figure 7: Vibration peak detected while shaker on.

Content from this work may be used under the terms of the CC BY 3.0 licence (© 2016). Any distribution of this work must maintain attribution to the author(s), title of the work, publisher, and DOI.

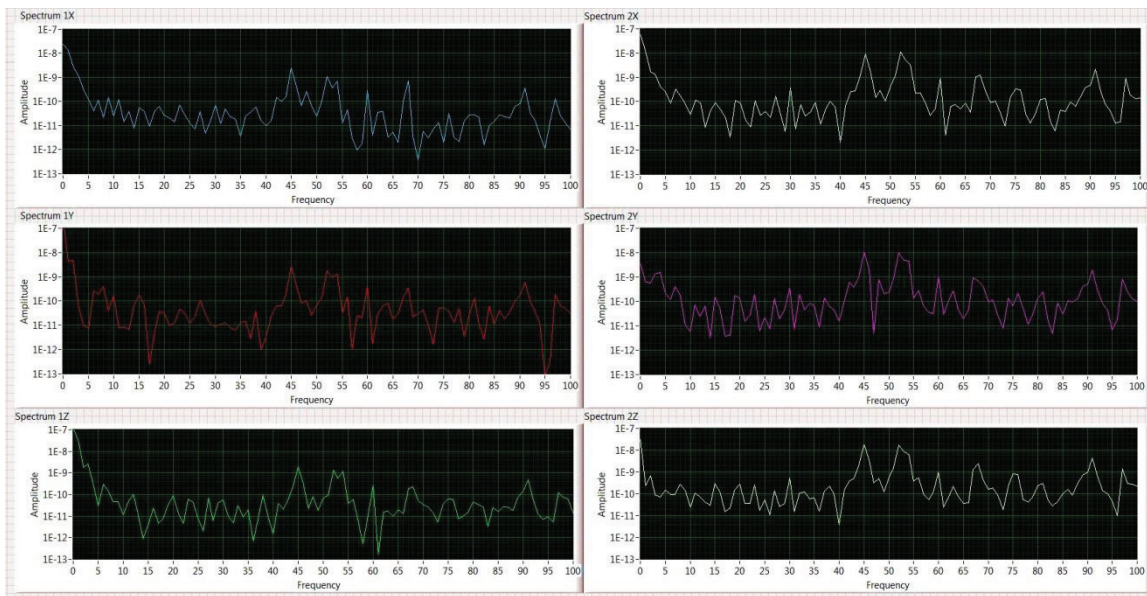

Figure 8: Vibration peak eliminated at one direction.

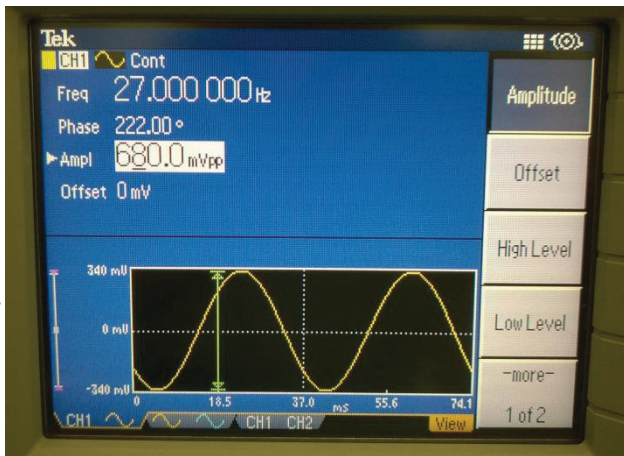

Figure 9: Amplitude and phase adjusting.

CONCLUSION

A testing girder set had been installed at the TPS inner ring lab. Two modified locking wedges with PZT modular were assembled for vibration elimination testing. At the preliminary testing stage, with a shaker to simulate the vibration source, the generated peak can be eliminated via a function generator output to the PZT with the amplitude and phase adjusted. However, the natural frequency peak induced by the environment white noise is hard to reduce or eliminate because the phase is not unique. Furthermore, the PZT arouse vibration peak at other direction indicated a six axes elimination system is demanded. Such a system is under fabrication.

REFERENCES

- [1] NSRRC website: <http://www.nsrcc.org.tw/english/tps.aspx>
- [2] TPS design handbook.
- [3] T.C. Tseng et al, “A precise 6-axies girder system with cam mover mechanism”, MEDSI(2006)

- [4] T.C. Tseng et al, “Design and prototype testing of the girder system for TPS”, SRI(2008)
- [5] T.C. Tseng et al, “Installation And Implementation Of An Auto-Alignment Girder System For TPS Storage Ring”, MEDSI(2014)
- [6] T.C. Tseng et al, “The Auto-Alignment Girder System of TPS Storage Ring”, PAC(2015)