

PRIMARY AND SECONDARY BEAM STABILIZATION AT THE ELBE ACCELERATOR FACILITY

R. Jainsch, M. Justus, T. Kirschke, U. Lehnert, P. Michel, W. Seidel, FZD, Dresden, Germany

Abstract

Since 2003, ELBE operates as a user facility for fundamental research and life sciences, providing highly brilliant electromagnetic radiation in a broad spectral range, as well as particle beams. The driving source is a 40 MeV, 1 mA electron LINAC in cw mode, utilizing a 13 MHz pulsed thermionic gun and Tesla acceleration technology. Infrared light from two FELs between 3 and 280 μm [1] is the foremost secondary radiation used at ELBE. For its applications, different demands in beam stability are put for successful experiments. Therefore, a feedback system for the electron beam position and energy in combination with IR beam intensity feedback using FPGA technology is under development. It is aimed at suppressing beam instabilities caused by thermal behaviour, microphonics and the 50 Hz mains frequency with upper harmonics. This article depicts hardware and software details of the measurement and feedback system and provides first performance results.

BEAM STABILITY CONSIDERATIONS

Near field IR microscopy or THz field research conducted at the FELBE [1] user facility require constant IR beam intensity in time scales of seconds to minutes due to averaging methods. Single pulse experiments at the High Magnetic Field Laboratory [2] need intensity stability up to the range of a few kHz, as the measurement time is around 50 ms. In case of lower wave numbers, measurements between water absorption lines or spectral gaps of the U100 FEL necessitate wavelength stability of less than 0.5%.

We have investigated the infrared power spectra of both the ELBE FELs at a wavelength of 11 μm (U27) and 42 μm (U100), varying the FEL detuning by shifting the optical resonator length. Figure 1 shows normalized spectra up to 10 kHz at different positions on the so called detuning curve (Fig. 2), where the main changes in spectral lines appear below 3 kHz. The (normalized) spectra were integrated up to that frequency, showing that the most stable regimes are from peak power (B) down the flat edge (C \rightarrow E). Usually, the FEL is run at about 90% of the peak power. The main frequency spikes are 50 Hz with multiple harmonics, 25 Hz, 10 kHz and 14 kHz as well. More detailed results were published in [3].

Looking at the well known undulator formula below, one sees that the wavelength of the spontaneous emission radiation depends on electron beam energy and trajectory, if the undulator geometry and the magnetic field are fixed. The total FEL power can then mainly be influenced by the primary beam current and may also be affected by the electron beam trajectory due to the geometrical

constraints of the coupling out mirror. In addition, thermal-mechanical effects lead to misalignment of the optical resonator and can not completely be compensated by the automatic length adjustment. To stabilize both the infrared wavelength and power, one has therefore first to care for electron beam stabilization in terms of energy and position.

$$\lambda = \frac{\lambda_u}{2\gamma^2} (1 + K_{RMS}^2 + \gamma^2 \theta^2)$$

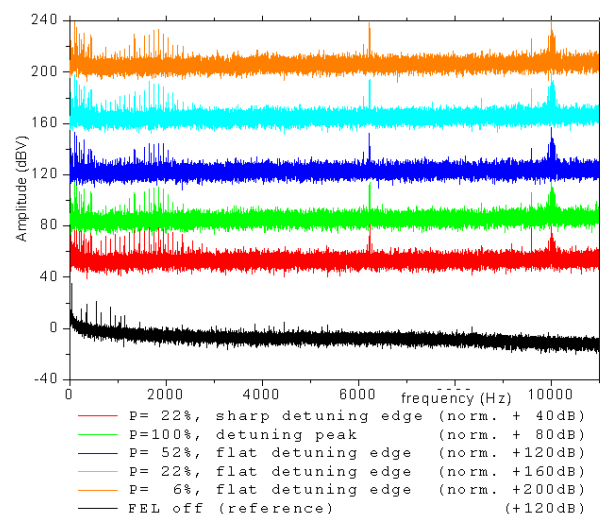

Figure 1: Infrared power spectra at 42 μm , 13 MHz cw electron beam with 50pC. The peak power of the out coupled beam (P=100%) is 35.7 W.

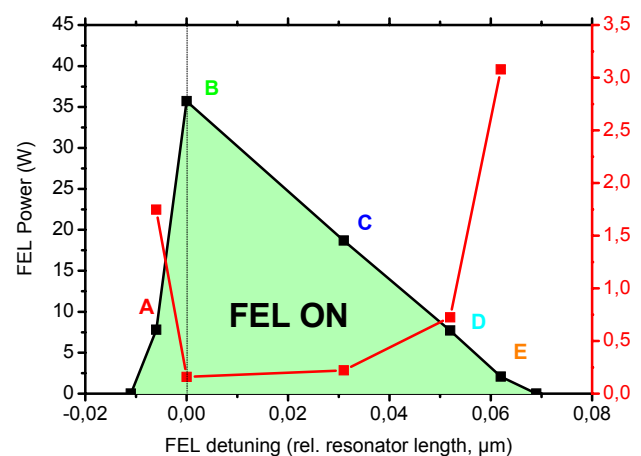

Figure 2: FEL detuning curve (black) and normalized power spectrum from integrated from 0...3 kHz.

We observe three main types of primary beam instabilities:

- Long term drift of the energy due to thermal transients of the superconducting TESLA cavities with 2nd order delay behaviour. The time constants can be deduced to be about 30 minutes.
- Beam position fluctuations due to charging effects in the injector, residual modulations of magnetic fields and beam energy variations (Fig. 1b).
- Beam energy fluctuations caused by the RF system and the cryogenics (cavity microphonics, synchronisation jitter, 50Hz-disturbances), ranging from LF to RF components.

BEAM ENERGY FEEDBACK

To handle the first mentioned type of instabilities, a standardized loop has been developed and implemented earlier [4]. An adaptive PI controller, run on PLC technology on top of the low level RF (LLRF) control system, adjusts the RF field gradient of the last accelerating cavity according to the beam energy. We measure this by the displacement in a dispersive section of the beam line, using beam position monitors as described by Evtushenko et al. [5].

Figure 3 shows the loop scheme. It may be pointed out that the beam position monitor output is smoothed by a low pass filter ($T_F = 30s$). The controller parameters are calculated in runtime using standard PID tuning rules and optimizing towards zero-overshoot behaviour. Figure 4 shows the typical response of the loop: the horizontal BPM reading is kept constant while the RF gradient decreases over several hours.

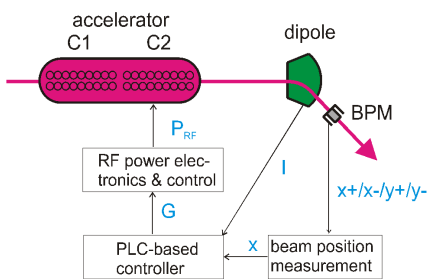

Figure 3: Beam energy feedback loop scheme.

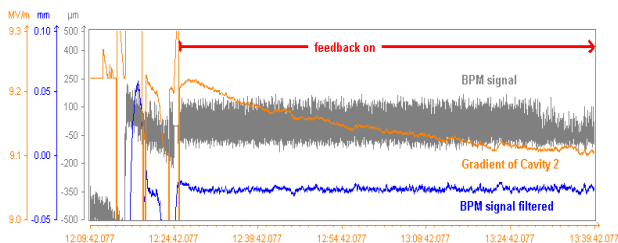

Figure 4: Beam energy feedback loop response during RF cavity settlement (total measuring time: 90 min).

This system has been working well for four years now at the Bremsstrahlung facility of ELBE [6], where long term experiments with a strong statistical demand are run. Position fluctuations remain at a peak-to-peak level of 50...200 μm , which corresponds to a $\partial E/E_{nom}$ of $2.5 \cdot 10^{-4} \dots 10^{-3}$. It has been adapted to the FEL beam line as well with comparable performance.

FEL POWER FEEDBACK

Of course there are permanent endeavours to identify and eliminate the sources of FEL Power fluctuations. Such are or were residual magnetic fields of the macro buncher deflection coils (25Hz, 10 kHz), TESLA cavity microphonics by the helium supply system (~ 7 Hz) or beam line vibration from vacuum pumps (~ 14 kHz).

In Addition, we develop a feedback system for the FEL power using the electron beam current to compensate for slow drifts and step like fluctuations caused by the optical system. The current setup is shown in Fig. 5, applying a scatter wire detector and PLC control technology: The infrared beam is scattered back by a 40 μm tungsten wire, focused, chopped and captured by an AC-coupled DTGS detector (Bruker FIR-DTGS D210/3 with PE window, [7]). The chopper runs at up to 1.5 kHz, synchronized to the macro bunching reference clock. The S&H unit is phase-locked with the chopper. To operate with a sufficient dynamic range at any IR power and wavelength conditions, a motor driven iris aperture is used and the adjustable 0...40 dB output amplifier generates a 0...10V standard signal. An adaptive PI control algorithm based on a PLC controller (Simatik S7-400, [8]) at a sampling rate of 100 Hz was implemented. The transmission of the gate voltage set value to the static -250kV gun HV level is done via optical field bus technology at 12 Mbit/s.

To calculate the proportional controller gain, the slope of the overall transfer function between electron beam current and FEL power signal must be measured for any given FEL setup before closing the loop. The integral part was fitted to the mean value of the dominating time constant heuristically and has, once found, proven to be sufficiently stable.

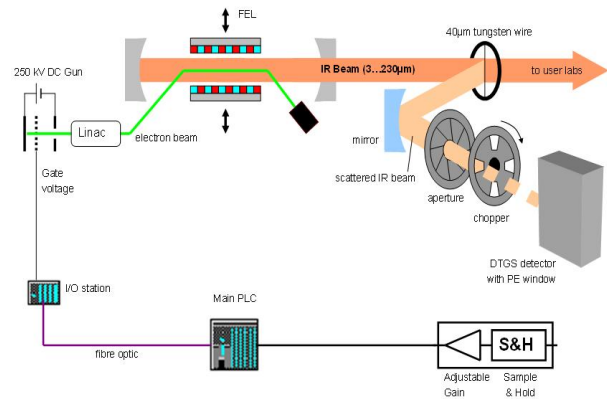

Figure 5: FEL power feedback loop with PLC controller.

As a performance test, a sine wave disturbance was modulated onto the current of a vertical steering coil located between the two accelerator stages, exciting a periodic electron beam displacement in the undulator and thus an FEL intensity modulation of about 20%. The frequency response of the PLC based system showed that up to 5 Hz disturbances can be significantly suppressed (Fig. 6, blue curve). The limitation is clearly seen in the low controller repetition rate and the rather slow data transmission. The PLC technique was then replaced by an FPGA controller (National Instruments NI-7833R, [9]) and a high performance AM fibre optic transmission line, directly coupling to the gate voltage controller reference using a buffer amplifier. The overall performance could be improved by one order of magnitude in frequency domain (Fig. 6, orange curve). Here, the chopper and the DTGS detector limit the performance.

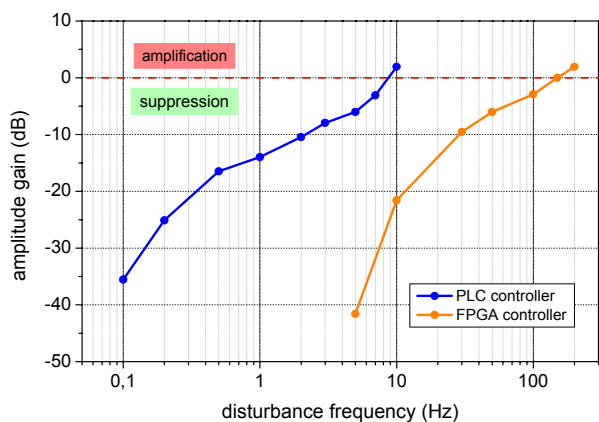

Figure 6: Frequency response of PLC and FPGA system.

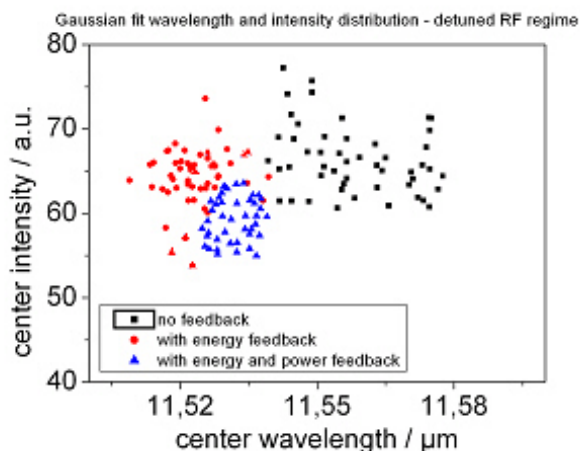

Figure 7: Improvement in wavelength and power distribution of the FEL by electron beam energy feedback combined with FEL power feedback (detuned electron beam, FEL U27 running at 11.55 μm , 10W).

CONCLUSION & LOOKOUT

An interesting issue is the impact on the long term spectral stability of the infrared light. With the PLC solution, a series of FTIR measurements (50 spectra within 10 minutes) has been carried out on an artificially destabilized electron beam regime, which can occur when the machine underlies thermal transients short after powering up. Figure 7 shows the distribution of measured centre wavelength and centre intensity without any feedback, with electron beam energy feedback only and also with and with FEL power feedback in addition. A decrease of the spectral distribution width to 25% and an improvement of the peak power distribution by a factor of 2 can be clearly seen.

Our current efforts are directed towards implementation of a multidimensional combined electron beam position & energy feedback system. This is a necessity, as the existing solution may misinterpret beam position changes caused by magnetic instabilities as to be of energetic origin. Also, the bandwidth of the whole control system has to be increased further. Therefore, we work on replacing the chopped DTGS detector system (which has poor phase stability) by a high performance DC coupled detector system that has to cover the complete FEL wavelength range. Also, an underlying fast AC feedback loop integrated in the LLRF system is thought of.

REFERENCES

- [1] W. Seidel et al., "Three years of cw-operation at FELBE - Experiences and applications", Proceedings of the 30th International Free Electron Laser Conference, Gyeongbuk, Korea, Aug. 24-29, 2008.
- [2] J. Wosnitza et. al., "Science at the Dresden High Magnetic Field Laboratory", AIP Conference Proceedings 1003 (2008), 311-315.
- [3] P. Michel et. al., "Investigation and improvement of beam stability at the ELBE FELs", Proceedings of the 30th International Free Electron Laser Conference, Gyeongbuk, Korea, Aug. 24-29, 2008.
- [4] M. Justus et. al., "Design of an Electron Beam Energy Control Loop using Transverse Dispersion", Proceedings of DIPAC 2007, Venezia, Italy, May 20-23, 2007.
- [5] P. Evtushenko, "Electron Beam Diagnostics at the Radiation Source ELBE", 10th Beam Instrumentation Workshop, Brookhaven National Laboratory, Upton, NY, May 6-9, 2002.
- [6] R. Schwengner et. al., "The photon-scattering facility at the superconducting electron accelerator ELBE", Nucl. Instr. and Meth. A 555 (2005) 211-219.
- [7] www.bruker.com.
- [8] www.automation.siemens.com.
- [9] www.ni.com.