

KALYPSO: LINEAR ARRAY DETECTOR WITH CONTINUOUS READ-OUT AT MHz FRAME RATES

Ch. Gerth*, B. Steffen, Deutsches Elektronen-Synchrotron DESY, Hamburg, Germany
M. Caselle†, L. Rota‡, Karlsruhe Institute of Technology (KIT), Eggenstein-Leopoldshafen, Germany
D.R. Makowski, A. Mielczarek, Lodz University of Technology (TUL), Łódź, Poland

Abstract

The novel linear array detector KALYPSO has been developed for beam diagnostics based on 1-dimensional profile measurements at high-repetition rate free-electron lasers (FEL) and synchrotron radiation facilities. The current version of KALYPSO has 256 pixels with a maximum frame rate of 2.7 MHz. The detector board, which comprises the radiation sensor, analog signal amplification, and analog-to-digital signal conversion, has been designed as a mezzanine card that can be plugged onto application-specific carrier boards for data pre-processing and transmission. Either a Si or InGaAs sensor can be mounted for the detection of visible or near infrared radiation. Results obtained in several beam diagnostics applications at the European XFEL and FLASH are presented to demonstrate the powerful capabilities of the KALYPSO detector.

INTRODUCTION

KALYPSO, a linear array detector - sometimes also denoted as 1D detector or line scan camera - has been developed for beam diagnostics applications based on the measurement of 1-dimensional distribution at high-repetition rates. A continuous data read-out at frame rates of up to 2.7 MHz has been achieved at the storage ring KARA [1]. In this paper we present results obtained at the Free Electron Laser at Hamburg (FLASH) [2] and European XFEL (EuXFEL) [3]. At FLASH, KALYPSO has been utilised to monitor the spectral distributions of FEL radiation pulses at an online spectrometer. At EuXFEL, electro-optical spectral decoding has been applied for the measurement of longitudinal bunch profiles, and near-infrared spectra of coherent diffraction radiation have been recorded for the study of micro-bunching instabilities.

DETECTOR SYSTEM OVERVIEW

The detector has been designed in a modular architecture: the radiation sensitive part, analog signal amplification, and analog-to-digital signal conversion are placed on a mezzanine card [1], which can be plugged onto application-specific carrier boards. A FPGA mezzanine card (FMC) carrier board has been developed for data acquisition and transmission to the accelerator front-end electronics in Micro Telecommunication Computing Architecture (MicroTCA.4)

standard [4] for integration into the control system and synchronisation to the accelerator timing system. The signal transmission via optical fibres enables a separation of a few hundred meters between the FMC carrier and the accelerator front-end electronics. A picture of the FMC carrier equipped with the KALYPSO mezzanine card is shown in Fig. 1.

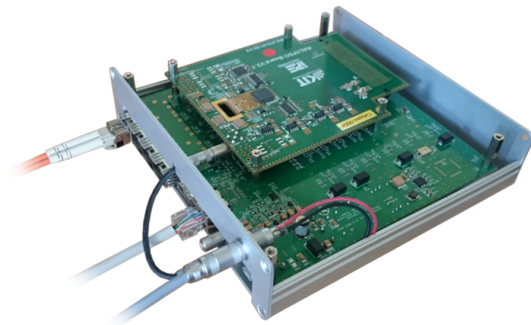

Figure 1: Photograph of the FMC carrier equipped with the KALYPSO mezzanine card.

A block diagram of the detector system is depicted schematically in Fig. 2. Currently, micro-strip sensors with 256 pixels and a width of 50 μm can be mounted on the KALYPSO mezzanine card. Up to now, two types of sensors have been employed: Si sensors for the detection of visible radiation, and InGaAs sensors that are sensitive in the wavelength range 900 nm to 1.7 μm . Each pixel of the sensor is bonded to an input channel of two modified versions of the GOTTHARD chip [5] that comprise analog signal amplification and 16:1 multiplexers. The resulting 16 differential outputs of both GOTTHARD chips are connected to a commercial 16-channel ADC (AD9249, Analog Devices) with 14-bit resolution that is operated at a sampling rate of 54 MHz. Compared to the original GOTTHARD chip, the correlated-double-sampling stage and automatic gain switching have been omitted in order to achieve a maximum frame rate of 2.7 MHz.

The FMC carrier [6] incorporates a FPGA (7-series Artix, Xilinx) and a DDR3 memory for data acquisition from the ADC on the KALYPSO mezzanine card as well as data processing and transmission via optical links to the accelerator front-end electronics. The accelerator front-end electronics is realized with a commercially available MicroTCA.4 board (MFMC, AIES) equipped with a FMC board for fast SFP communication (FMC-2SFP+, CAENels) which is connected via an optical fibre to one optical link of the FMC carrier. The total latency for data acquisition and processing of one frame with 256 pixels is less than 1 μs . This low

* christopher.gerth@desy.de

† Now at Gesellschaft für Schwerionenforschung, Darmstadt, Germany

‡ Now at SLAC National Accelerator Laboratory, Menlo Park, California, United States

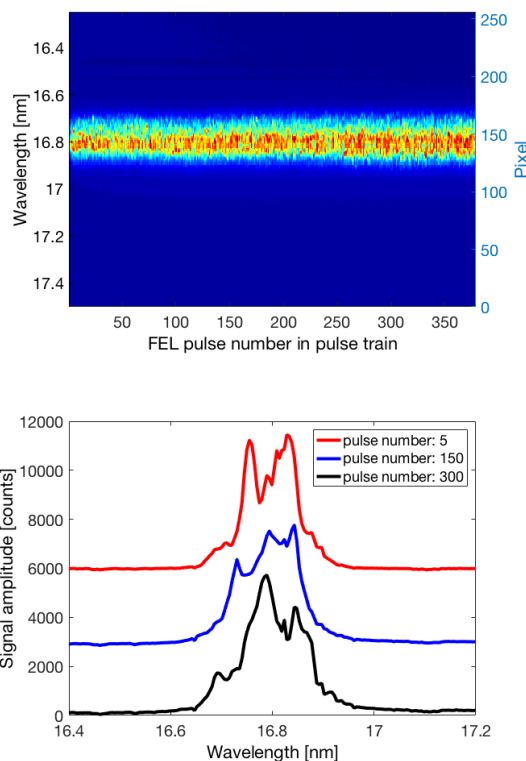
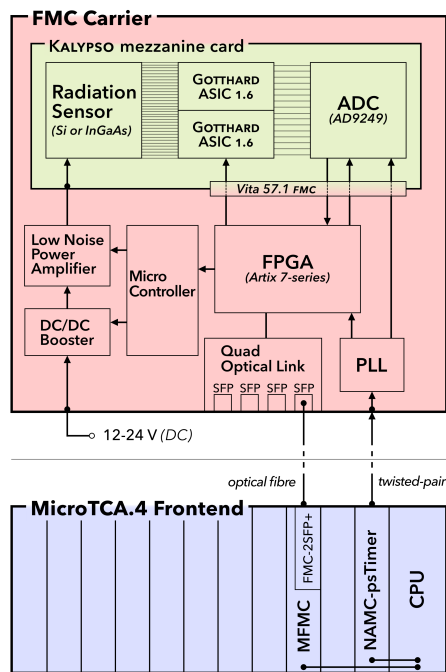

Figure 2: Simplified block diagram of the detector system. The FMC carrier (red) for data acquisition and control of the KALYPSO mezzanine card (green) is connected to the accelerator front-end electronics in MicroTCA.4 standard (blue) via optical fibres and twisted-pair cables. (from Ref. [6])

Figure 3: (top) Pulse-resolved spectra recorded at a repetition rate of 1.0 MHz for a single pulse train with 380 FEL pulses. (bottom) Three individual spectra, offset vertically for better distinction. (from Ref. [6])

latency of data transmission [7] and processing is tremendously useful in real-time control system applications. For example, the data can be directly streamed to the low-level RF controller of the EuXFEL accelerator [8] and used for beam-based feedbacks.

Clock and trigger signals for electron bunch or photon pulse synchronous data recording are received from a MicroTCA.4 board (NAMC-psTimer, N.A.T.) of the accelerator timing system. The signals are distributed inside each MicroTCA crate via dedicated timing lines to other electronic boards or via RJ-45 sockets to external devices such as the FMC carrier. The clock signal is cleaned from jitter in a phase-locked loop (PLL) and provided to the FPGA, GOTTHARD chips and ADC.

XUV SPECTROMETER AT FLASH

The super-conducting linac at FLASH operates at 10 Hz repetition rate with bursts of up to 800 bunches at a maximum repetition rate of 1.0 MHz and drives both FEL beamlines FLASH1 and FLASH2. FLASH1 is a single-pass FEL based on self-amplified spontaneous emission (SASE) for which the exponential amplification process starts from spontaneous emission (shot noise). As a consequence, the FEL radiation is of stochastic nature, i.e. individual FEL pulses vary in intensity and spectral distribution. Many user experiments are sensitive to the wavelength of the FEL radiation and demand information on the spectral distributions of the individual FEL pulses. For the monitoring of pulse-resolved

FEL spectra, a KALYPSO detector equipped with a Si sensor has been installed at the variable line spacing (VLS) grating spectrometer [6]. The VLS spectrometer is equipped with two gratings for which the blaze angles are optimised for 0th order diffraction such that the main part of the FEL radiation is transferred to the user experiment, while a few percent of the FEL radiation intensity is dispersed into the 1st order and focused onto a Ce:YAG crystal. The visible fluorescence light of the Ce:YAG crystal is imaged onto the Si sensor of the KALYPSO detector. By this, the spectral distribution of the incident FEL pulses is converted into signal intensities of the 256 pixels of the Si microstrip sensor.

Figure 3 shows the pulse-resolved FEL spectra of a pulse train with 380 pulses measured with the KALYPSO detector at a repetition rate of 1.0 MHz as well as three individual spectra for the pulse numbers 5, 150, and 300. The FEL spectra exhibit many spikes which result from the SASE amplification process. The average FEL pulse energy was about 50 μ J, and the pulse duration was about 100 fs (FWHM). FLASH operators use this online measurement of the FEL spectra for accelerator tuning to keep the FEL pulses along the pulse train within a spectral bandwidth of about 1%, which is the typical spectral width of the FEL radiation. The FEL spectra are stored in a central data acquisition (DAQ) system, and the information about the spectral shape of individual FEL pulses can be used for post analysis of experimental results, e.g. to improve the spectral resolution.

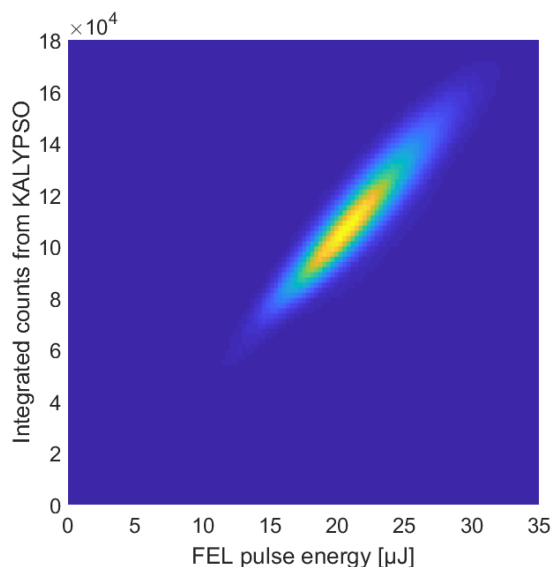

Figure 4: Correlation plot of integrated signal amplitudes measured with KALYPSO and photon pulse energies measured with a GMD. (from Ref. [6])

To determine the intensity response, including the Ce:YAG crystal and KALYPSO detector system, the sum of the signal amplitudes for all pixels of a spectrum can be compared to the absolute photon pulse energy measured with a gas-monitor detector (GMD) [9] upstream of the VLS spectrometer. Figure 4 shows a correlation plot in which more than $6 \cdot 10^5$ integrated signal amplitudes of individual spectra are plotted against the corresponding pulse energies recorded simultaneously with the GMD. A nearly linear correlation can be identified for the range of measured values.

EO DIAGNOSTICS AT EUXFEL

The super-conducting linac of EuXFEL delivers bunch trains of up to 2700 electron bunches at a repetition rate of 10 Hz. Three magnetic chicanes are used for longitudinal bunch compression. After the second bunch compressor at a beam energy of 700 MeV, a detection system based on electro-optical spectral decoding (EOSD) [10] has been installed to measure longitudinal profiles with single-bunch resolution.

The EOSD system [11] has a time resolution (rms) of about 200 fs and utilizes a Gallium Phosphide (GaP) crystal that is installed inside the electron beam pipe. This electro-optically active GaP crystal becomes birefringent in the presence of a Coulomb field of an electron bunch passing by. The birefringence induces a modulation in the polarization of a co-propagating chirped laser pulse from an Ytterbium fibre laser, which is synchronized to the radio frequency of the EuXFEL accelerator. By using a polarizer, the polarization modulation is transferred to an intensity modulation in the spectral distribution of the chirped laser pulse. The spectrum of the chirped laser pulse is then measured with a custom-made grating spectrometer utilizing a KALYPSO detector equipped with an InGaAs sensor.

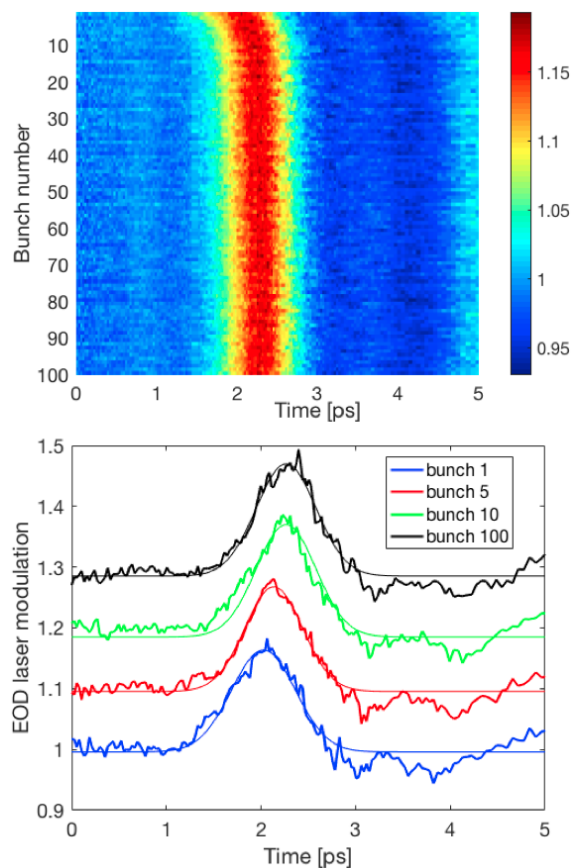

Figure 5: (top) Bunch-resolved norm. laser modulations recorded at a repetition rate of 1.13 MHz for a single bunch train with 100 bunches. (bottom) Four individual laser modulations, i.e. longitudinal bunch profiles, which have been offset vertically for better distinction.

The upper plot of Fig. 5 displays the normalized laser modulations, i.e. longitudinal profiles, of a bunch train filled with 100 bunches at an intra bunch-train repetition rate of 1.13 MHz. The lower plot shows four individual longitudinal profiles together with Gaussian fits from which the rms bunch length can be deduced.

The mean and standard deviation of the rms bunch length calculated for each bunch number for 1000 consecutive bunch trains is shown in Fig. 6. The mean rms bunch length changes from about 330 fs to 310 fs over the first 10 bunches and remains then constant. The error bars indicate the standard deviation, i.e. rms bunch length jitter, which amounts about 10 fs.

NIR SPECTROMETER AT EUXFEL

A custom-made, prism-based near infra-red (NIR) spectrometer [12] has been installed at the EuXFEL for the study of microbunching effects in the micrometer wavelength range by monitoring non-invasively the Coherent Diffraction Radiation (CDR) generated by the electron bunches passing through an aluminum screen with a hole. The NIR spectrometer is located after the main accelerator at an electron beam energy of 14 GeV and utilizes a KALYPSO detector system

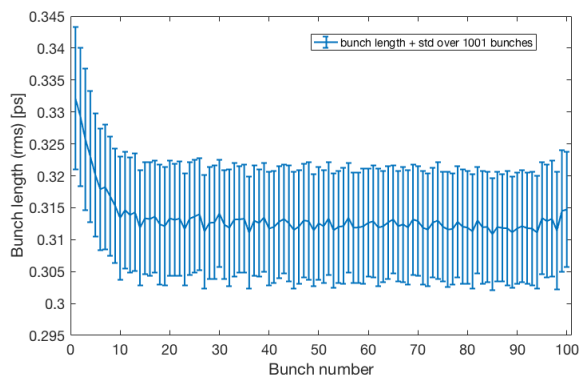

Figure 6: Mean and standard deviation of the rms bunch length along the bunch train for 1000 consecutive bunch trains. The intra bunch-train repetition rate was 1.13 MHz.

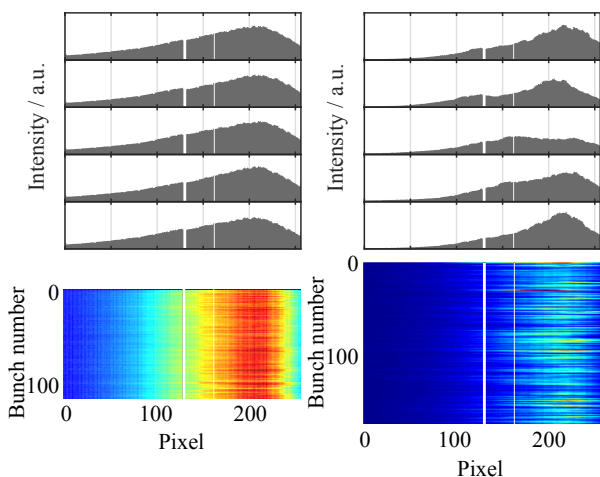

Figure 7: Example spectra of the NIR spectrometer recorded at 1.13 MHz. Longer wavelengths towards higher pixel number (uncalibrated). Left column: uncompressed beam. Right column: FEL compression settings. Top: Selected spectra. N.B. vertical scales differ: compressed signal ~ 100 times weaker. Bottom: Whole bunch trains, demonstrating differences in shot-to-shot fluctuations. (from Ref. [12])

equipped with an InGaAs sensor, sensitive in the wavelength range 0.9–1.7 μm .

Figure 7 shows example spectra of the NIR spectrometer recorded at a repetition rate of 1.13 MHz. Uncompressed bunches in the left column and bunches at compression settings for FEL operation in the right. The overall intensity decreased by almost 2 orders of magnitude when the bunches were compressed. This is in accordance with earlier results from FLASH, where microbunching was observed in the micrometer range for lower compression settings. With compression settings for FEL operation, the relative bunch-to-bunch variance increased.

SUMMARY

The linear array detector KALYPSO has been developed for beam diagnostics applications which demand continuous MHz readout rates and low latency. KALYPSO is a

collaborative effort between the Karlsruhe Institute of Technology (KIT), Paul Scherrer Institut (PSI), Lodz University of Technology (TUL-DMCS), and Deutsches Elektronen-Synchrotron (DESY). A new version of KALYPSO with up to 1024 pixels with a pitch of 25 μm is currently under development.

ACKNOWLEDGEMENTS

G. Brenner, S. Düsterer, D. Haack, V. Rybnikov, and K. Tiedtke (DESY) participated in the XUV spectrometer measurements at FLASH. S. Fahlström (Uppsala University) designed and built the NIR Spectrometer at the EuXFEL.

REFERENCES

- [1] L. Rota *et al.*, “KALYPSO: Linear array detector for high-repetition rate and real-time beam diagnostics,” *Nucl. Instrum. Methods Phys. Res. A*, vol. 936, pp. 10–13, 2019. doi: 10.1016/j.nima.2018.10.093
- [2] W. Ackermann *et al.*, “Operation of a free-electron laser from the extreme ultraviolet to the water window,” *Nature Photonics*, vol. 1, pp. 336–342, Jun. 2007. doi: 10.1038/nphoton.2007.76
- [3] W. Decking *et al.*, “Status of the European XFEL,” in *Proceedings of the IPAC 2019*, Melbourne, Australia, 2019, pp. 1721–1723. doi: 10.18429/JACoW-IPAC2019-TUPRB020
- [4] <https://www.picmg.org/openstandards/microtca/>
- [5] A. Mozzanica *et al.*, “The GOTTHARD charge integrating readout detector: Design and characterization,” *Journal of Instrumentation*, vol. 7, no. 01, p. C01019, 2012.
- [6] C. Gerth *et al.*, “Linear array detector for online diagnostics of spectral distributions at MHz repetition rates,” *Journal of Synchrotron Radiation*, vol. 26, no. 5, pp. 1514–1522, Sep. 2019. doi: 10.1107/S1600577519007835
- [7] D. Makowski, G. Jabłoński, P. Prędko, and A. Napieralski, “Low Latency Data Transmission in LLRF Systems,” in *24th Conference, PAC’11*, vol. C110328, New York, USA, Mar. 2011, pp. 887–889.
- [8] D. Makowski *et al.*, “High-Speed Data Processing Module for LLRF,” *IEEE Transactions on Nuclear Science*, vol. 62, no. 3, pp. 1083–1090, Jun. 2015, issn: 0018-9499. doi: 10.1109/TNS.2015.2416120
- [9] K. Tiedtke *et al.*, “Gas detectors for x-ray lasers,” *Journal of Applied Physics*, vol. 103, no. 9, p. 094511, 2008. doi: 10.1063/1.2913328
- [10] B. Steffen *et al.*, “Electro-optic time profile monitors for femtosecond electron bunches at the soft x-ray free-electron laser FLASH,” English, *Physical Review Special Topics - Accelerators and Beams*, vol. 12, no. 3, 2009. doi: 10.1103/PhysRevSTAB.12.032802
- [11] B. Steffen, M. Czwalińska, C. Gerth, and P. Peier, “First electro-optical bunch length measurements from the European XFEL,” in *Proceedings of the IBIC 2018*, Shanghai, China, 2018.
- [12] S. Fahlström, M. Hamberg, C. Gerth, N. M. Lockmann, and B. Steffen, “NIR spectrometer for bunch-resolved, non-destructive studies of microbunching at European XFEL,” in *Proceedings of the FEL 2019*, Hamburg, Germany, 2019. doi: 10.18429/JACoW-FEL2019-WEP035