



Toward an Energy Recovery Linac x-ray source at Cornell University

Georg Hoffstaetter
Cornell Physics Dept. / LEPP

- The ERL principle
- Studies for an x-ray ERL at Cornell University
- Limits of ERLs



CESR @ Cornell



CHES & LEPP

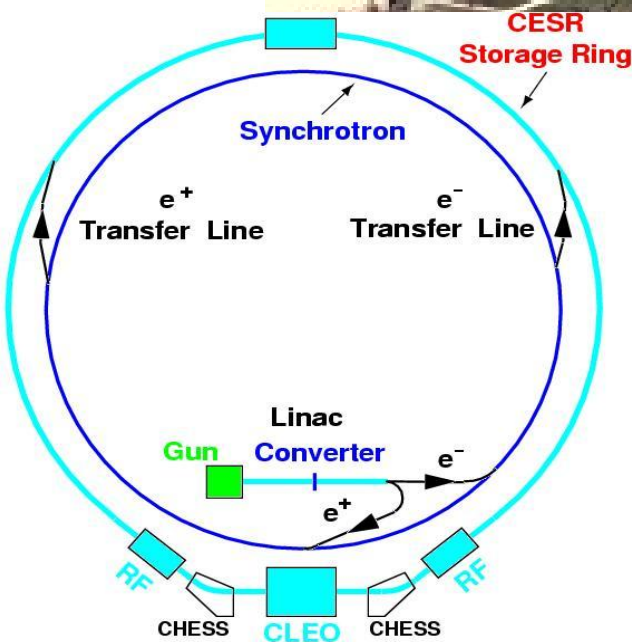



Beam Size in a Linear Accelerator



CHESS & LEPP

The beam properties are to a very large extent determined by the injector system:

- The horizontal beam size can be made much smaller than in a ring
- While the smallest beams that are possible in rings have almost been reached, a linear accelerator can **take advantage of any future improvement** in the electron source or injector system.

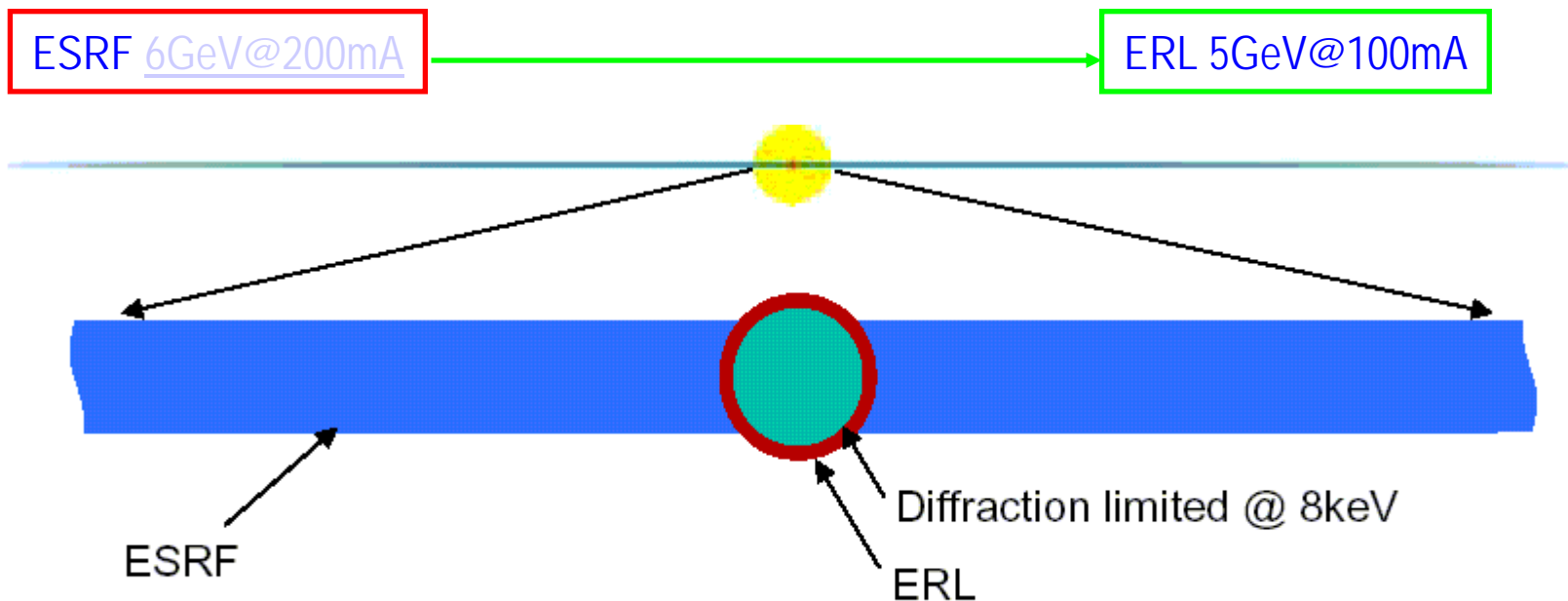

courtesy Ivan Bazarov



Smaller Beams and more Coherence



CHESS & LEPP

- Coherent x-ray diffraction imaging
- It would, in principle, allow atomic resolution imaging on non-crystalline materials.
- This type of experiments is completely limited by coherent flux.

Factor 100 more coherent flux for ERL
for same x-rays, or provide coherence for
harder x-rays

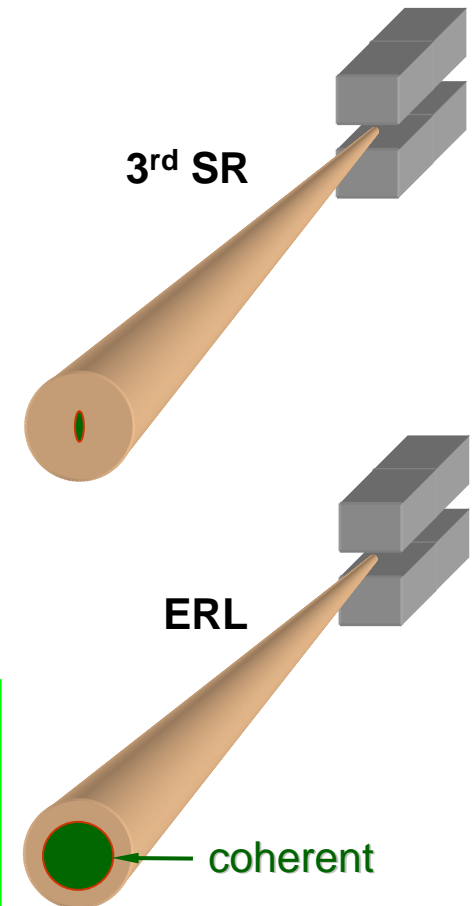



Bunch length in a Linac



CHESS & LEPP

- The bunch length can be made much smaller than in a ring
- While the shortest bunches possible in rings have almost been reached, a linear accelerator can take advantage of any future improvement in the source or injector system.

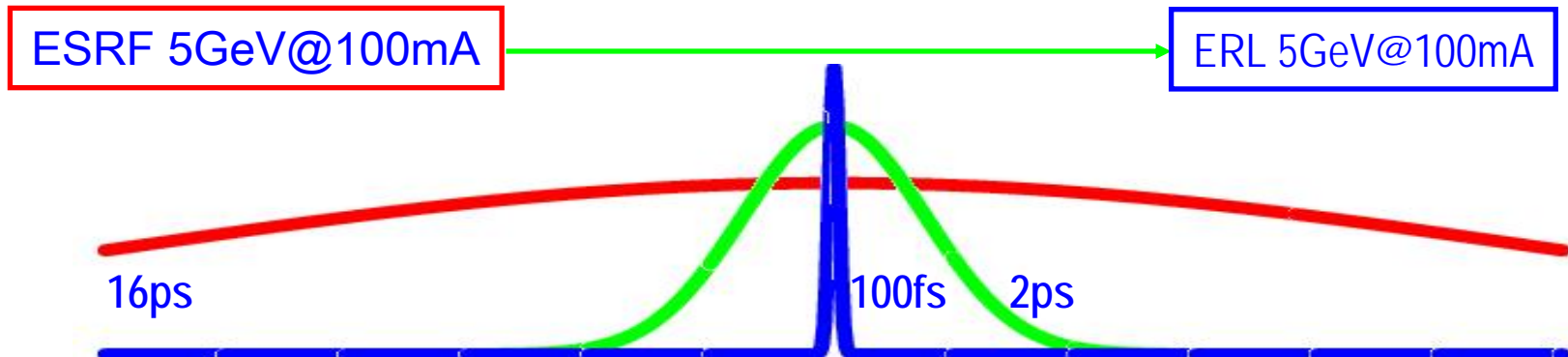



Pro and Con for an x-ray Linac



CHESS & LEPP

As compared to a ring, the beam properties are largely determined by the injector system:

- The bunch length can be made much smaller than in a ring
- Smaller emittances
- Higher coherence fraction

ESRF 6GeV@200mA

ERL 5GeV@100mA

Current of 100mA and energy of 5GeV leads to a beam power of 0.5GW !!!

The energy of the spent beam has to be recaptured for the new beam.

As compared to a ring, the beam properties are largely determined by the injector system:

- The bunch length can be made much smaller than in a ring
- Smaller emittances
- Higher coherence fraction

ESRF 6GeV@200mA

ERL 5GeV@100mA

Current of 100mA and energy of 5GeV leads to a beam power of 0.5GW !!!

The energy of the spent beam has to be recaptured for the new beam.



Goals



CHES & LEPP

Modes:	Short-Term Goals			Long-Term Goals		Units
	(A) Flux	(B) High- Coherence	(C) Short- Pulse	(D) Ultra High- Coherence	(E) Ultra Short- Pulse	
Energy	5	5	5	5	5	GeV
Current	100	25	1	100	1	mA
Bunch charge	77	19	1000	77	10000	pC
Repetition rate	1300	1300	1	1300	0.1	MHz
Norm. emittance	0.3	0.08	5.0	0.06	5.0	mm mrad
Geom. emittance	31	8.2	511	5.1	511	pm
Rms bunch length	2000	2000	50	2000	20	fs
Relative energy spread	2 10 ⁻⁴	2 10 ⁻⁴	3 10 ⁻³	2 10 ⁻⁴	3 10 ⁻³	
Beam power	500	125	5	500	5	MW
Beam loss	< 1	< 1	< 1	< 1	< 1	micro A



Optimistic Outlook



CHESS & LEPP

- The ERL parameters are dramatically better than present 3rd generation storage rings
- The use of ERL **microbeams**, **coherence**, and **ultra-fast timing** will lead to new unique experiments that can be expected to transform the way future x-ray science experiments are conducted
- Most critical parameters to achieve in an ERL are therefore, **narrow beams**, **small emittances**, **short bunches**, at large currents.

Parameter	APS ring	ERL*	Gain factor
Rms source size(μm)	239(h) x 15(v)	2(h) x 2(v)	1/900 in area
x-ray beamsize	100nm - 1 μm	1 nm	100 to 1000
Coherent flux x-rays/s/0.1% bw	3×10^{11}	9×10^{14}	3,000
Rms duration	32 ps	0.1 ps	over 300



Flux and Brilliance



CHES & LEPP

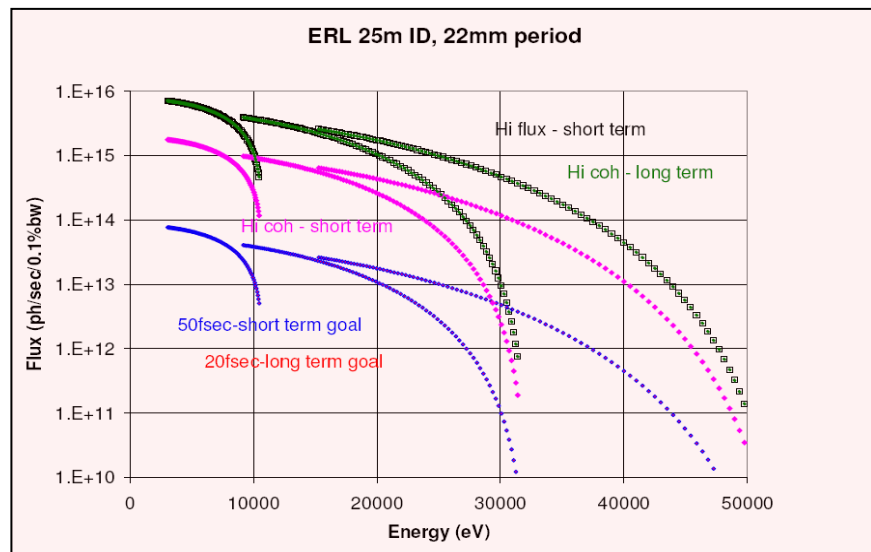
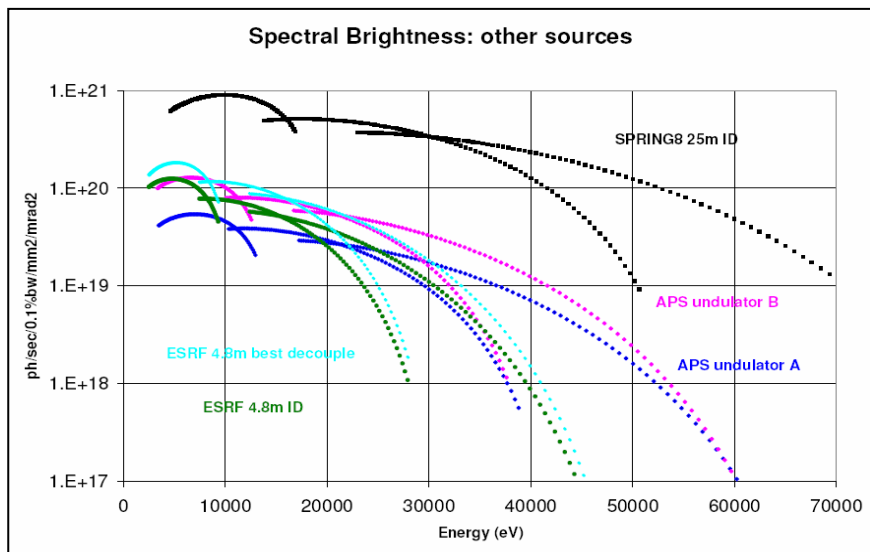
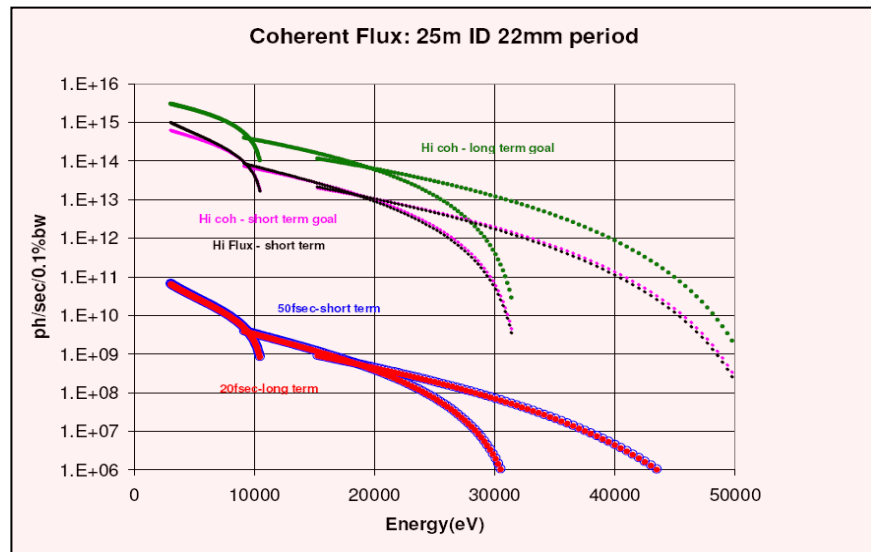
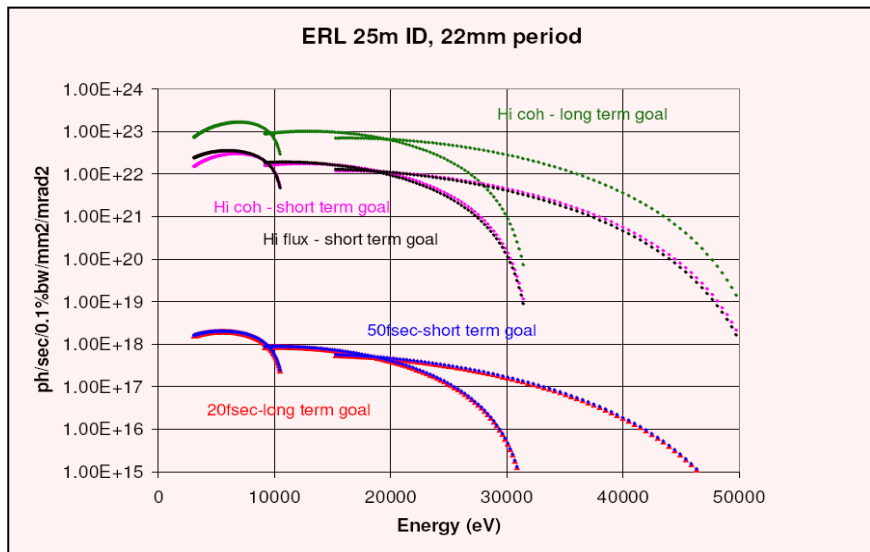



Accelerator Physics @ CESR



CHESS & LEPP

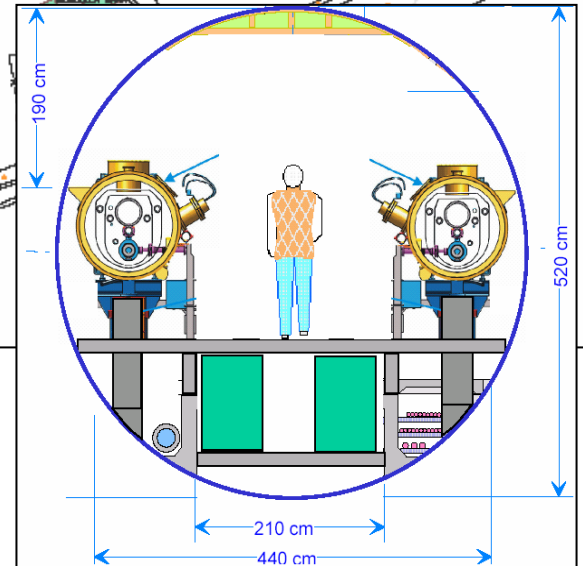
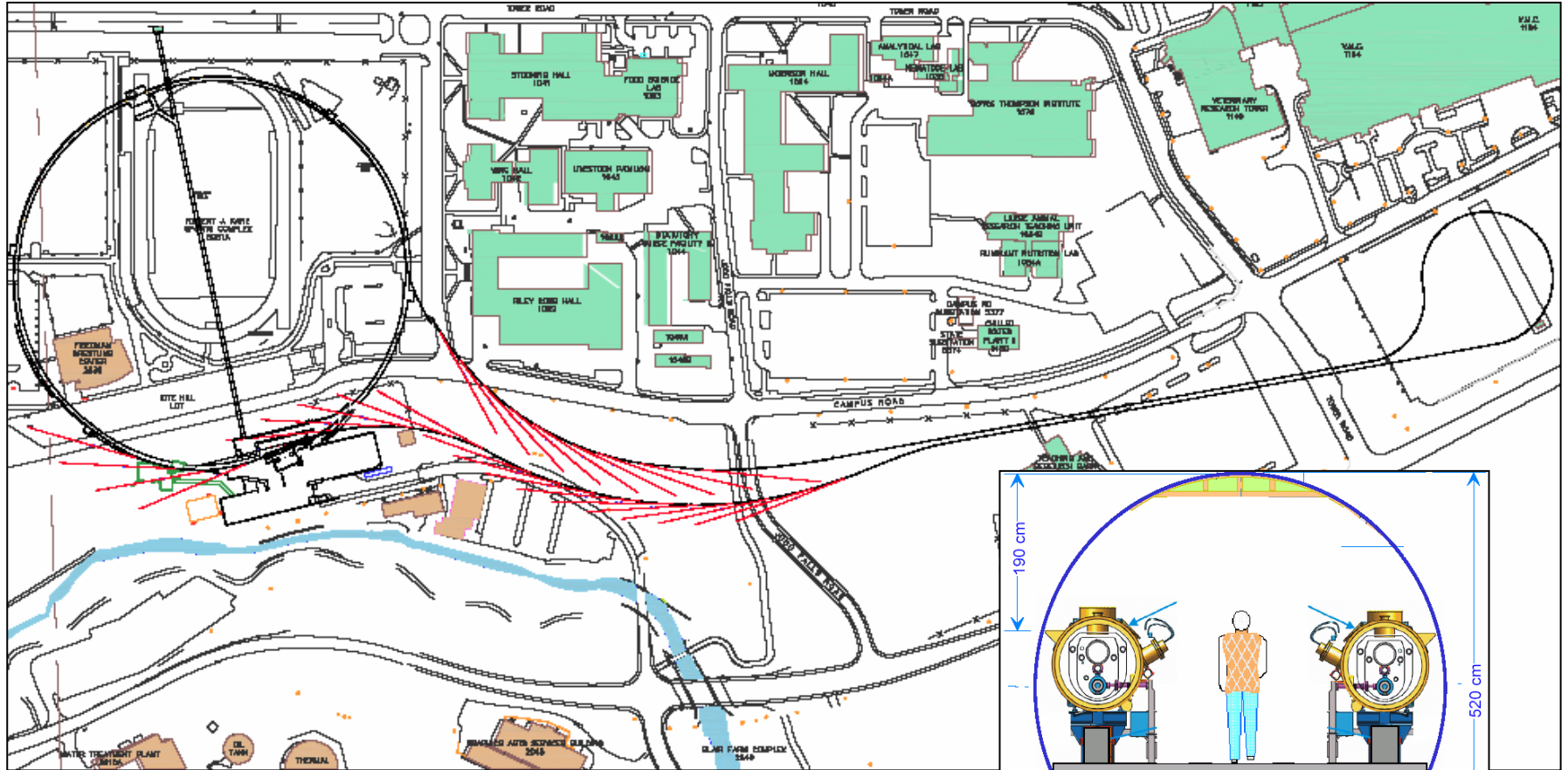



Advantages of ERL@CESR



CHESS & LEPP

- Operation of CESR and ERL test simultaneously.
- Use all of the CESR tunnel.
- Lots of space for undulators.
- Space for future upgrades, like an FEL.
- No basements of existing buildings to worry about.
- Only one tunnel for two linacs.
- Less competition, since other sights cannot offer upgrades.
- Example character for other existing light sources.



Limits to an ERL



CHESS & LEPP

Limits to Energy :

- Length of Linac and power for its cooling to 2K (supercond. RF)

Limits to Current :

- Beam Break Up (BBU) instability (collective effects)
- HOM heating (supercond. RF)

For small emittances in all 3 dimensions :

- Coulomb expulsion of bunched particles (Space Charge, e-Source)
- Radiation back reaction on a bunch (ISR and CSR)
- Nonlinear beam dynamics
- Ion accumulation in the beam potential
- Stability against ground vibration (μm level)

A Possible Apparatus for Electron Clashing-Beam Experiments (*).

M. TIGNER

Laboratory of Nuclear Studies, Cornell University - Ithaca, N. Y.

(ricevuto il 2 Febbraio 1965)

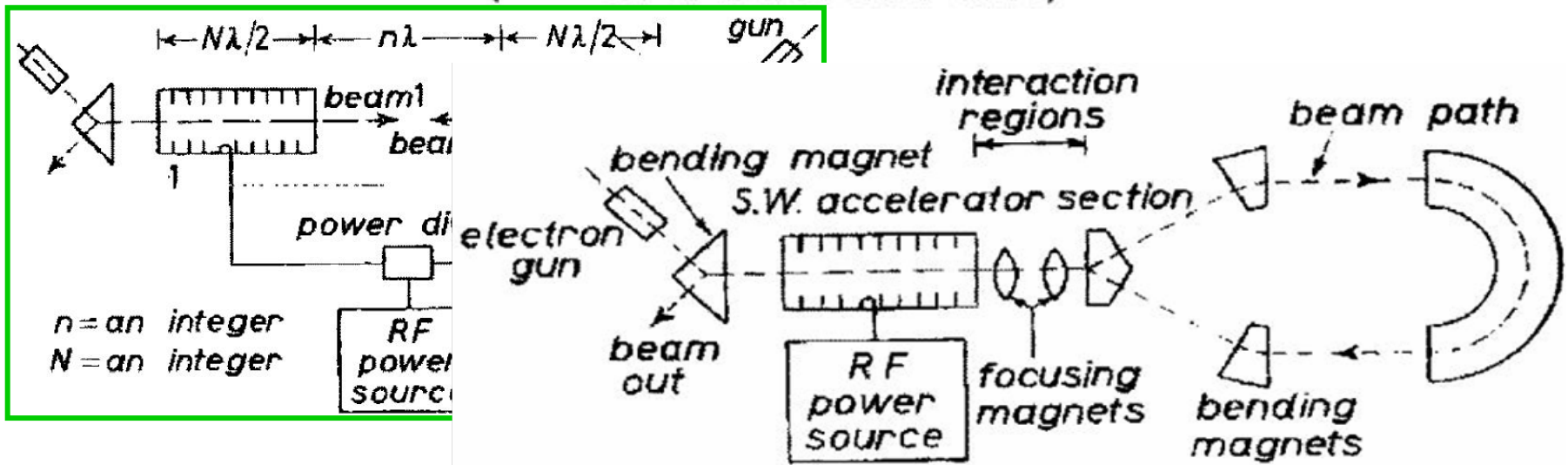

Energy recovery needs continuously fields in the RF structure

- Normal conducting high field cavities can get too hot.
- Superconducting cavities used to have too low fields.



Superconducting RF infrastructure



CHESS & LEPP

- RF measurement lab
- Shielded test pits, cryogenics
- Clean room
- Chemical handling
- Precision coordinate measurement
- Scanning electron microscope, Auger analysis
- Advanced μ -Kelvin thermometry

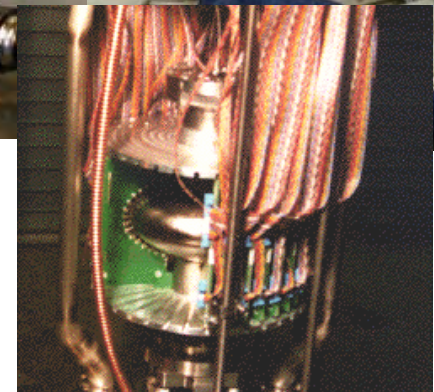
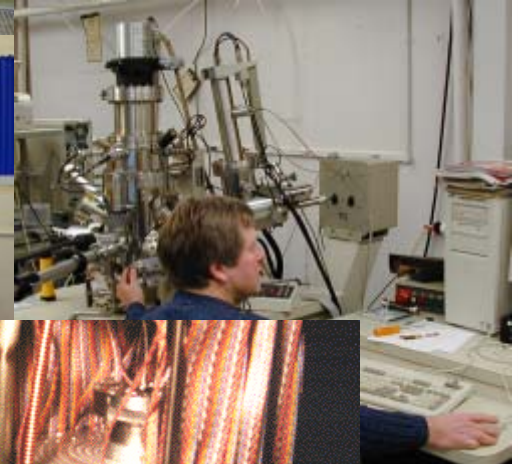
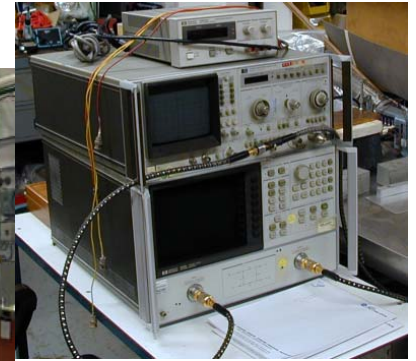

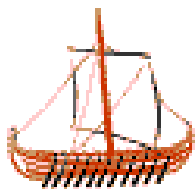

Ongoing ERL prototyping



CHESS & LEPP

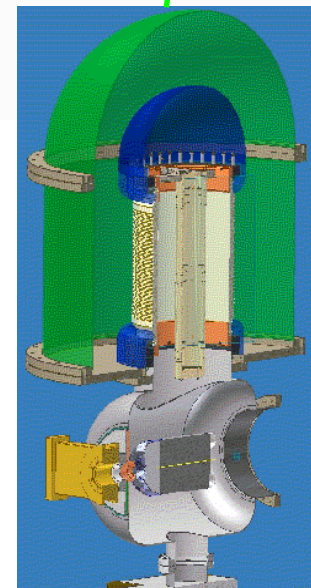
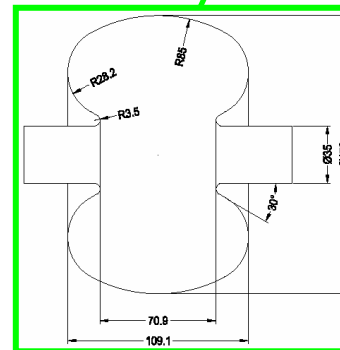
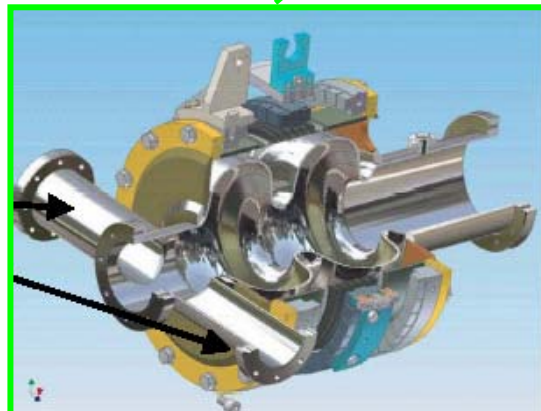
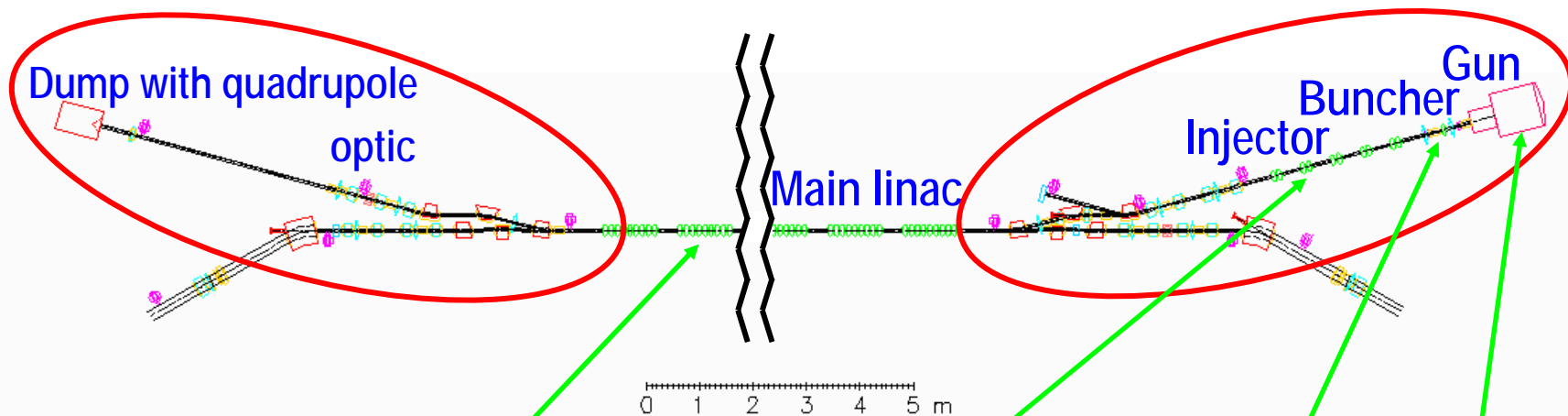



Ongoing Developments



CHESS & LEPP

1) DC electron source

- Gun development
- HV power supply
- Photocathode development
- ERL injector lab
- Laser system development

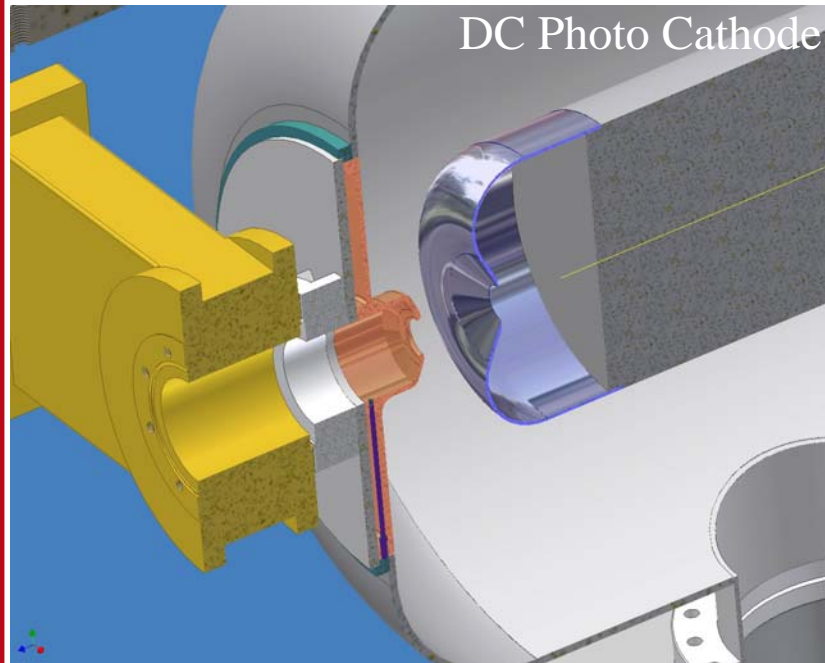

2) Superconducting RF

- RF control (tests at CESR/JLAB)
- HOM absorbers
- Injector klystron
- Input coupler (with MEPI)
- Injector cavity / Cryomodule

3) Beam dynamics

- Injector optimization with space charge
- Beam break up instability (BBU)
- Optics design / ion clearing

4) Accelerator design

- Optics
- Beam dynamics
- Beam stability

5) X-ray beamline design

- X-ray optics
- Undulator design



High loaded Q cavity control



CHESS & LEPP

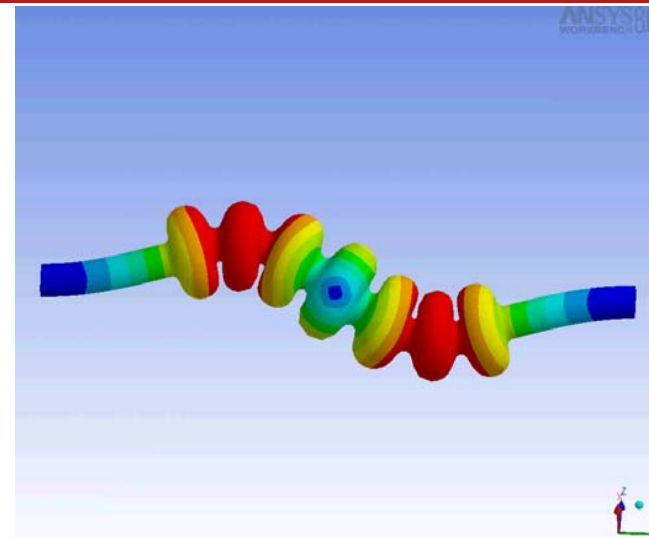
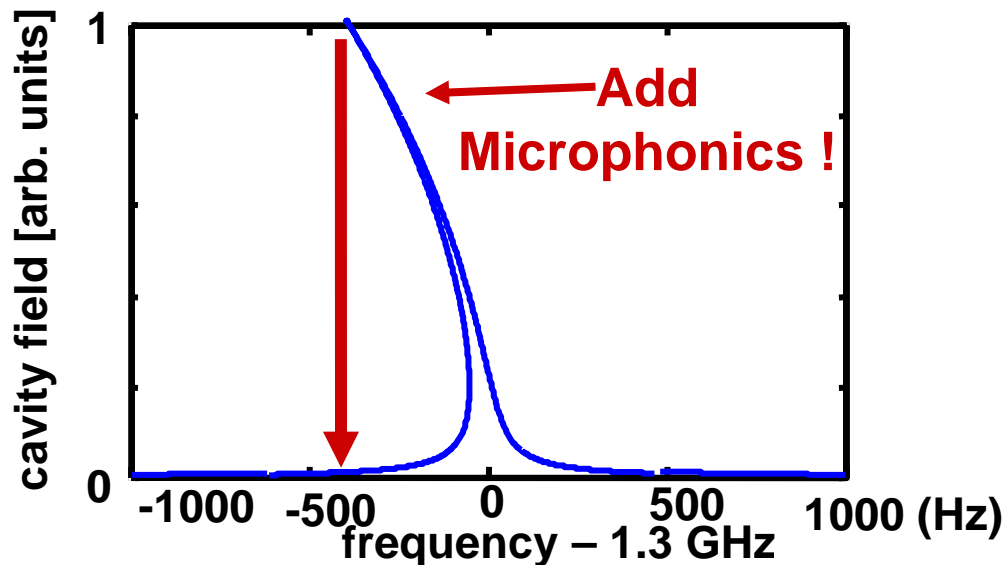

- Run cavity at highest possible loaded Q for Energy recovery linac mode, i.e. without beam loading
- But: The higher the loaded Q, the maller the cavity bandwidth!

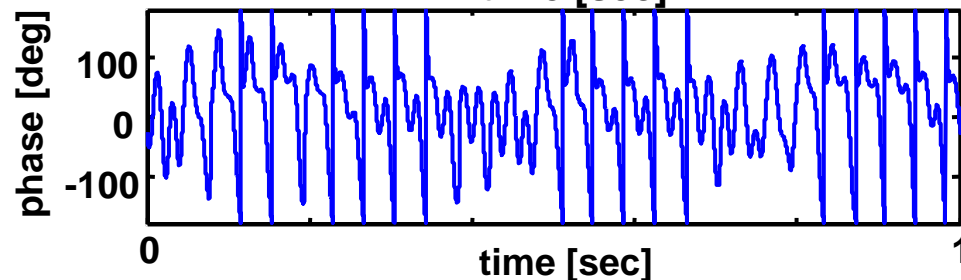
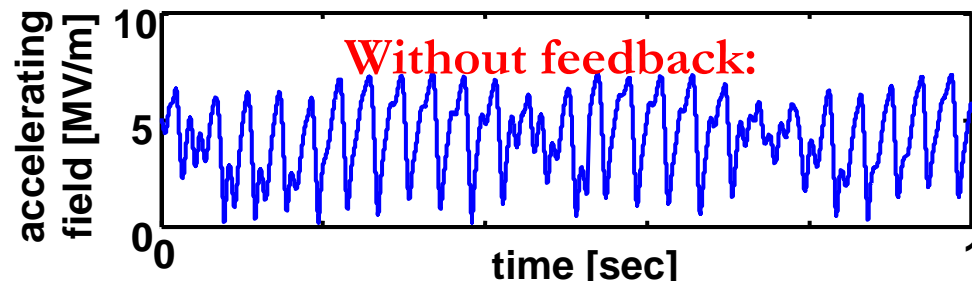



Current limit due to BBU



CHESS & LEPP

Beam breakup instability (BBU) in one dimension
(originally a major concern for current limit)

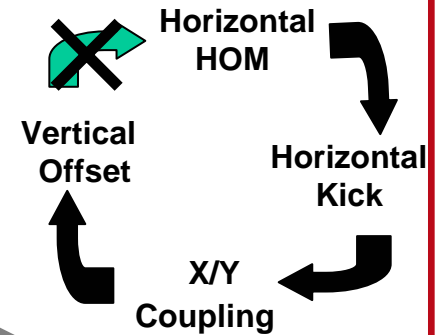

320 identical cavities



Current limited to 25mA

Randomized frequencies with rms of 10MHz



Current limited to 500mA

Polarized Cavities and x to y coupling



Current limited to 2000mA >> required 100mA

Now the current limited by a technical choice:
Cooling capacity of the HOM Dampers

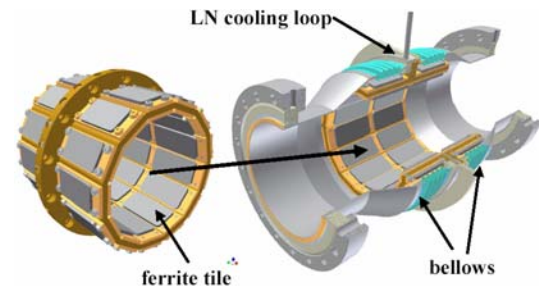



HOM with BBU: Starting from Noise



CHESS & LEPP

V/c Stable: current below threshold

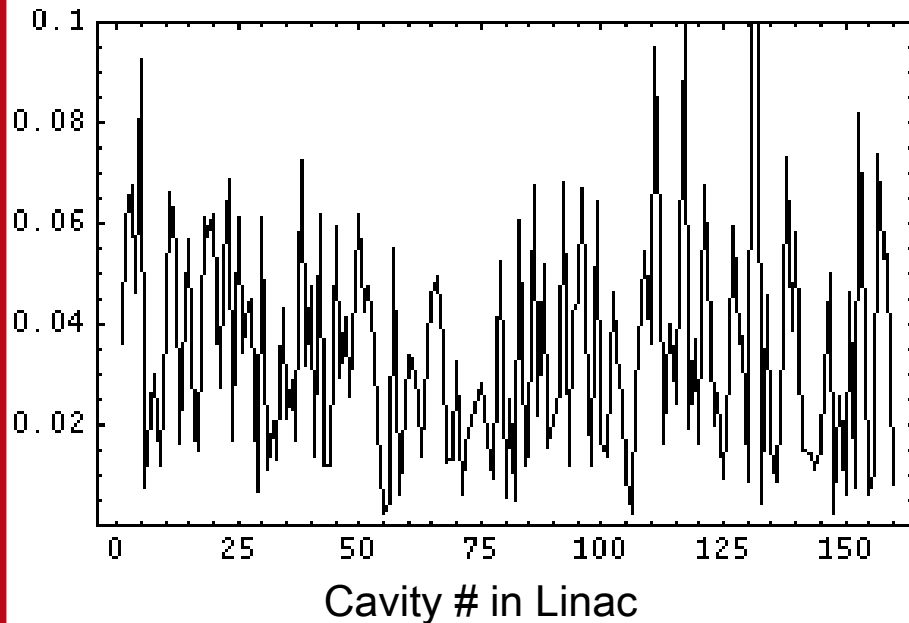

V/c Unstable: current above threshold

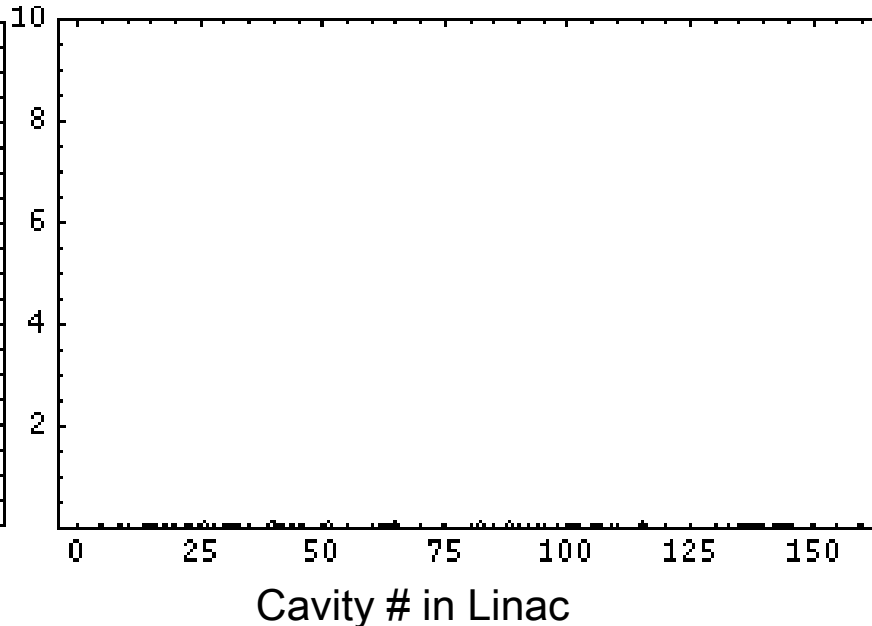



Isolation of modes



CHESS & LEPP

 $\log(I_{th} [A])$

One cavity, tow higher order modes.

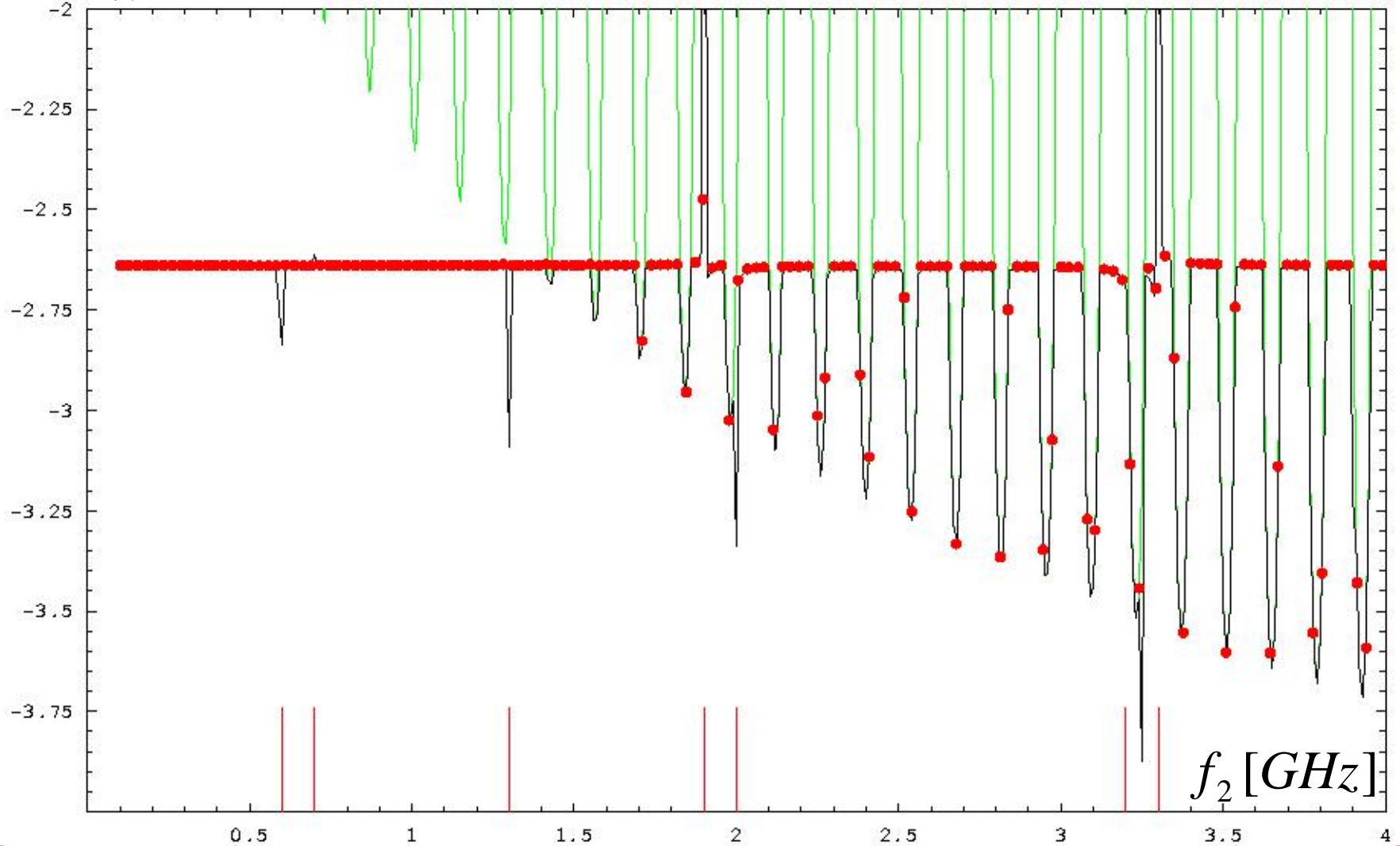



Randomization of frequencies

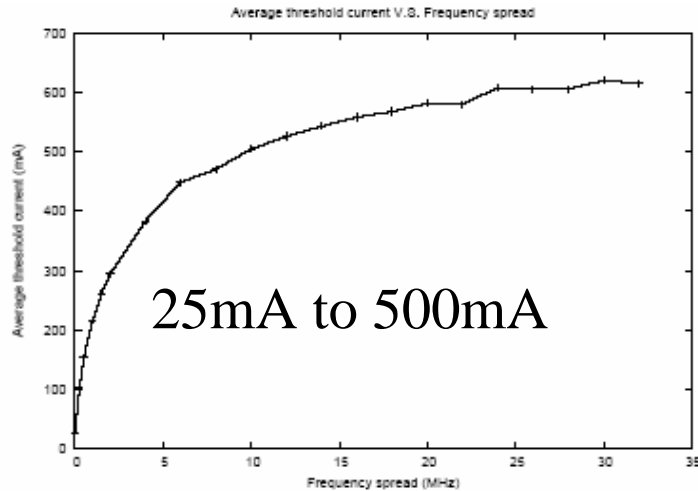

x/y frequency separation

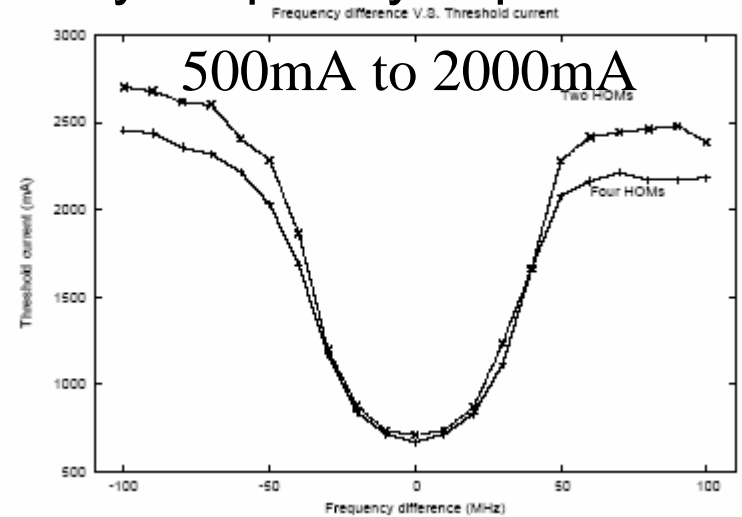

Model of
ERL@CESR
320 polarized
cavities with
 $f_x - f_y = 60\text{MHz}$
spread = 10MHz

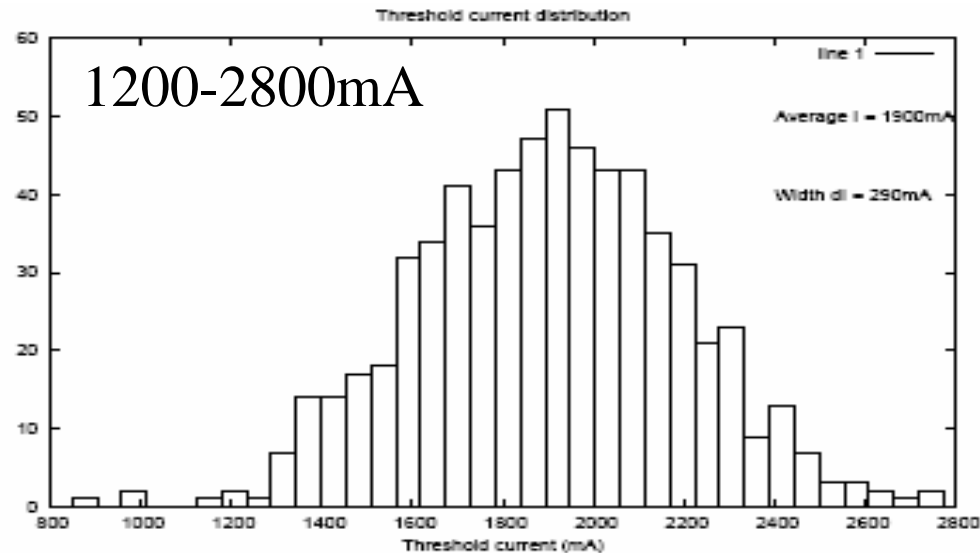



Ion accumulation in the beam potential



CHESS & LEPP

Ion are quickly produced due to high beam density

Ion	$\sigma_{col}, 10\text{MeV}$	$\sigma_{col}, 5\text{GeV}$	$\tau_{col}, 5\text{GeV}$
H_2	$2.0 \cdot 10^{-23} \text{m}^2$	$3.1 \cdot 10^{-23} \text{m}^2$	5.6s
CO	$1.0 \cdot 10^{-22} \text{m}^2$	$1.9 \cdot 10^{-22} \text{m}^2$	92.7s
CH_4	$1.2 \cdot 10^{-22} \text{m}^2$	$2.0 \cdot 10^{-22} \text{m}^2$	85.2s

- Ion accumulate in the beam potential. Since the beam is very narrow, ions produce an extremely steep potential – they have to be eliminated.
- Conventional ion clearing techniques can most likely not be used:
 - 1) Long clearing gaps have transient RF effects in the ERL.
 - 2) Short clearing gaps have transient effects in injector and gun.
- DC fields of about 150kV/m have to be applied to appropriate places of the along the accelerator, without disturbing the electron beam.



CSR Microbunching



CHESS & LEPP

Micro-bunching: Longitudinal Bunch Profile Measurements at FLASH

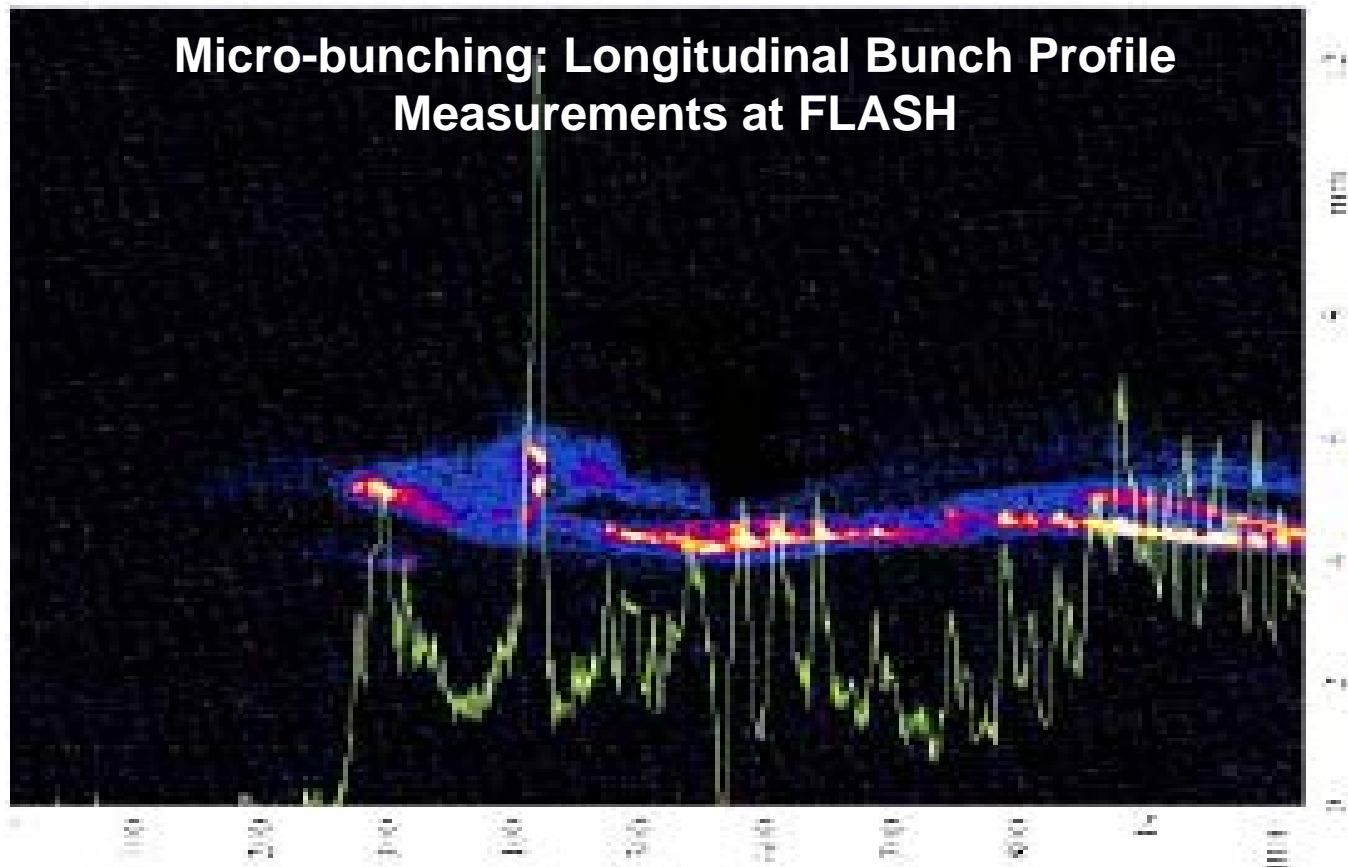

1 picosecond



CSR for 100fs bunch without spike



CHESS & LEPP

Horizontal emittance with coherent synchrotron radiation

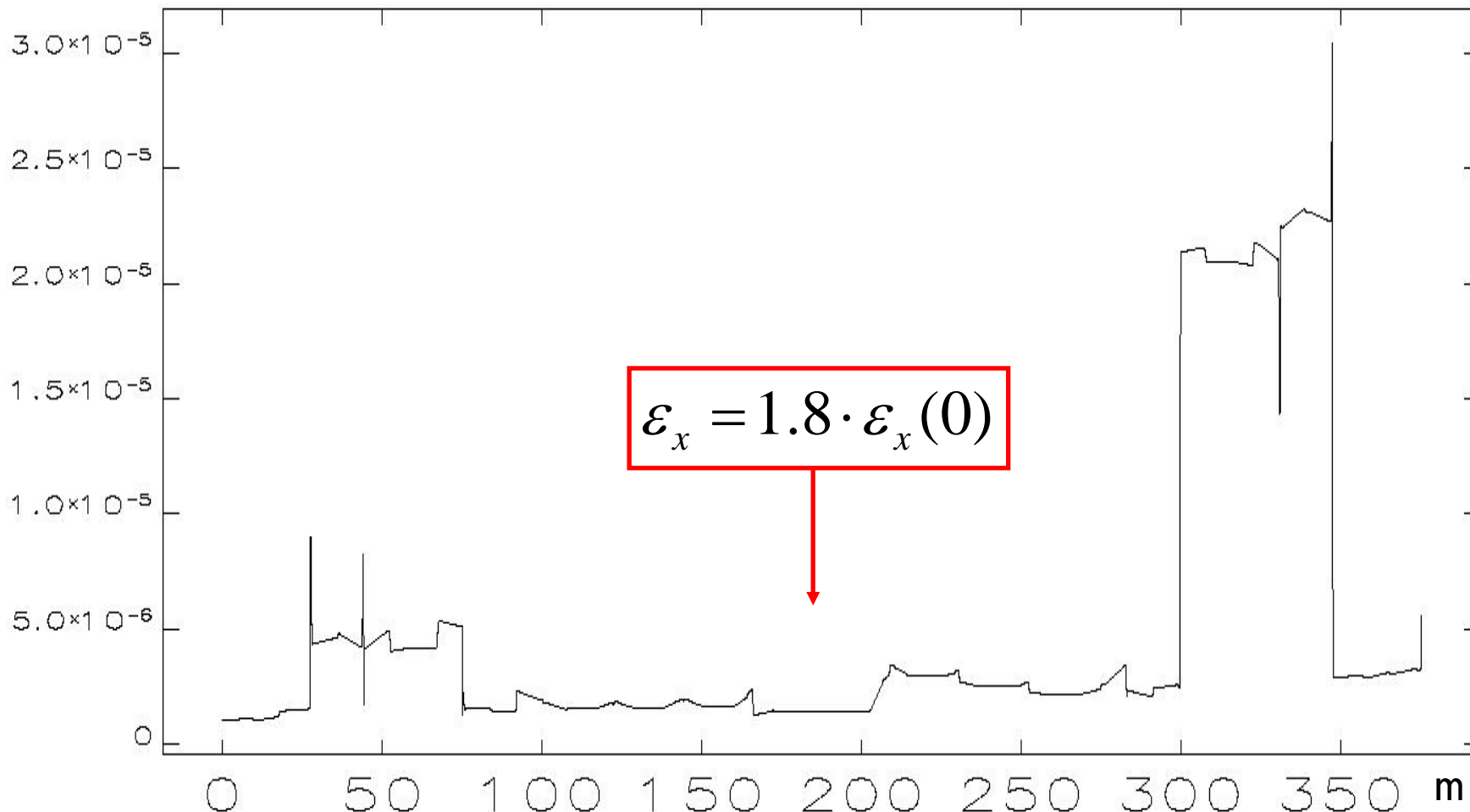

Result: After suitable nonlinear bunch length manipulation, the emittance growth can be controlled in all undulators.



Emittance growth along the X-ray ERL



CHESS & LEPP

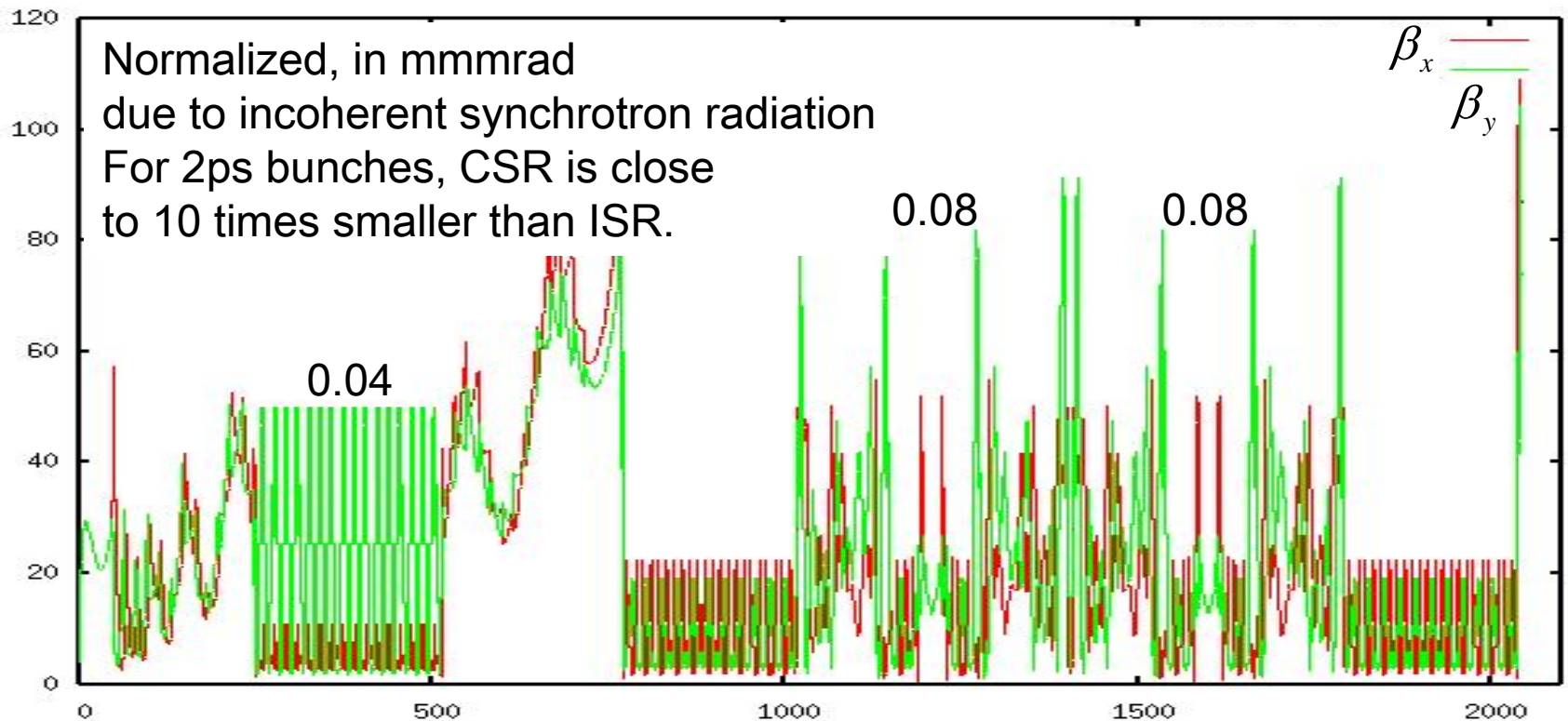

A mini-workshop on ultra low emittance light-sources in July addressed this issue.

Other analyzed sources of emittance growth:

Coupler kick \Rightarrow 7% of 10^{-6} m emittance
 \Rightarrow 30% of 10^{-7} m emittance



R&D toward an X-ray ERL



CHESS & LEPP

- Full average current injector with the specified emittance and bunch length
- Emittance preservation during acceleration and beam transport:
 - Nonlinear optics (code validation at CEBAF), coherent synchrotron radiation (JLAB, TTF), space charge
- Delivery of short duration (ca. 100 fs, and less in simulations), high charge bunches (TTF)
- Dependence of emittance on bunch charge
- Stable RF control of injector cryomodule at high beam power
- Stable RF control of main linac cavities at high external Q, high current, and no net beam loading (JLAB to 10mA)
- Understanding of how high the main linac external Q can be pushed (JLAB)
- Study of microphonic control using piezo tuners (JLAB, SNS, NSCL, TTF)
- Recirculating beam stability as a function of beam current with real HOMs, and benchmarking the Cornell BBU code (JLAB)
- Feedback stabilization of beam orbit at the level necessary to utilize a high brightness ERL
- Photocathode operational lifetime supporting effective ERL operation
- Performance of high power RF couplers for injector cryomodule
- Demonstration of non-intercepting beam size and bunch length diagnostics with high average current at injector energy and at high energy (TTF)
- HOM extraction and damping per design in injector and main linac (code validation from Prototype)
- Performance of HOM load materials to very high frequency
- Performance of full power beam dump
- Detailed comparison of modeled and measured injector performance
- Study of halo generation and control in a high average current accelerator at low energy and with energy recovery (JLAB)
- Study of beam losses and their reduction in recirculation of high average current with energy recovery (JLAB, NAA)
- Precision path length measurement and stabilization (Prototype, JLAB)



R&D toward an X-ray ERL



CHESS & LEPP

1. Emittance preservation during acceleration and beam transport
 2. Recirculating beam stability (JLAB)
 3. Diagnostics with high average current at injector energy and at high energy (TTF)
 Delivery of short duration (ca. 100 fs, and less in simulations), high charge bunches (TTF)
 4. Stable RF control of main linac cavities at high external Q, high current, and no net beam loading
 (JLAB to 10mA)
 Understanding of how high the main linac external Q can be pushed (JLAB)
 Study of microphonic control using piezo tuners (JLAB, SNS, NSCL, TTF)
- HOM extraction and damping per design in injector and main linac (code validation from Prototype)
 - Study of halo generation and control in a high average current accelerator at low energy and with energy recovery (JLAB)
 - Study of beam losses and their reduction in recirculation of high average current with energy recovery (JLAB, NAA)
 - Precision path length measurement and stabilization (Prototype, JLAB)