

FLASH UPGRADED - PREPARING FOR THE EUROPEAN XFEL

H. Schlarb* for the FLASH and the XFEL Project Team,
DESY, D-20607 Hamburg, Germany

Abstract

Since 2005, the Free electron LASer in Hamburg, FLASH, has delivered a high brilliance photon beam to users with a wavelength range between 13 nm and 40 nm. To meet the user demands for 4 nm wavelengths, sub-50 fs timing stability, and better pointing stability, the accelerator will be continuously upgraded within the next few years. The upgrade to an energy of 1.3 GeV, the development of a transverse and longitudinal intra-train feedback system, and a 3rd harmonic cavity at 3.9 GHz are key prototype tests for the European XFEL. FLASH also serves as a test bench for an entirely new approach to accelerator facility synchronization involving optical pulses distributed in length stabilized fibres. Increased stabilization of the electron beam peak current and its arrival time should provide the possibility to reliably seed the electron bunch with higher laser harmonics. In this paper, an overview of the planned upgrades for FLASH will be presented with respect to their usefulness for the European XFEL.

INTRODUCTION

Since 2005, the high-gain Free electron LASer in Hamburg, FLASH, successfully delivers to user experiments in the VUV-wavelength range between 13 nm and 40 nm ultra-short photon pulses (10-25 fs FWHM) with peak power at the Gigawatt level [1]. The peak brilliance of the FLASH photon beam exceeds that of state-of-the-art synchrotron radiation sources by seven orders of magnitude. Observations of the high degree of transverse and longitudinal coherence, intensity stability of the self-amplified spontaneous emission process, amplification gain measurements along the undulator and the content of high harmonics down to 2.6 nm are in full agreement with theoretical prediction.

The 13 nm wavelength achieved with this FEL is limited only by the 700 MeV maximum electron beam energy and is an important milestone for FLASH and the European XFEL as they set goals of reaching wavelengths of 6 nm and 0.1 nm, respectively. Besides photon production for users, FLASH serves as a small scale (\sim one tenth) prototype for the larger XFEL facility. The layouts of the facilities are shown in Fig.1 [3, 4].

The electron beam is produced in a laser-driven photoinjector using a normal conducting RF gun. The beam is accelerated in a linear accelerator comprised of eight 9-cell superconducting cavities housed in cryogenic modules. The kilo-Ampere's peak currents are achieved though two magnetic bunch compressors before the beam enters the

main linac section. Passing beam cleaning and protecting collimators, the electron bunches of typically 100 fs duration produce the SASE-FEL photons in long undulators. Key parameters of the machines are listed in Tab. 1[3, 4].

Most of the accelerator parameters impacting the electron beam dynamics, beam instrumentation, mechanical or RF tolerances are quite similar for the two facilities. The main differences are related to the electron beam energy, the accelerator and undulator length, the electron and the photon beam transport, and the photon diagnostics for Angstrom wavelengths. The large number of devices in the XFEL - about 100 acceleration modules - requires reliable mass-production by industry. FLASH can provide for the prototyping of single XFEL units and, within certain limitations, can also provide long-term reliability tests.

Table 1: Key parameter of FLASH and the European XFEL

Parameter	FLASH	XFEL
norm. emittance	2 μm	1.4 μm
peak current	2.5 kA	5.0 kA
bunch rep. rate	1(9) MHz	5 MHz
pulse rep. rate	10 Hz	10 Hz
bunch charge	1 nC	1 nC
beam energy	1.0 GeV	17.5 GeV
photon wavelength	6.3 nm	0.1 nm
acc. freq.	1.3/3.9 GHz	1.3/3.9 GHz
flat top duration	800 μs	650 μs
facility length	260 m	3.4 km
undulator length	30 m	250 m
orbit tolerance und.	5 μm	3 μm

Bunch compression for the XFEL takes place at beam energies that are \sim 4 times higher than in FLASH. The higher energies and the smaller R_{56} of the XFEL chicanes reduce the sensitivity to micro-bunch instabilities and relax the tolerances on the RF amplitude stability. Dedicated diagnostics for temporal and spatial bunch profiling up to the second bunch compressor - the most critical part of the accelerator - are essentially the same. Therefore, almost all critical accelerator sub-systems can be tested and prototyped at FLASH, allowing for reduced costs, a rapid XFEL commissioning, and minimized risk. In this paper, the various FLASH upgrades relevant for the XFEL are described.

ENERGY UPGRADE TOWARD 1.3 GEV

During the spring shutdown of 2007, a new accelerator module ACC6 - almost the XFEL design module - has been installed. The average gradient of ACC6 is 28.5 MV/m

* holger.schlarb@desy.de

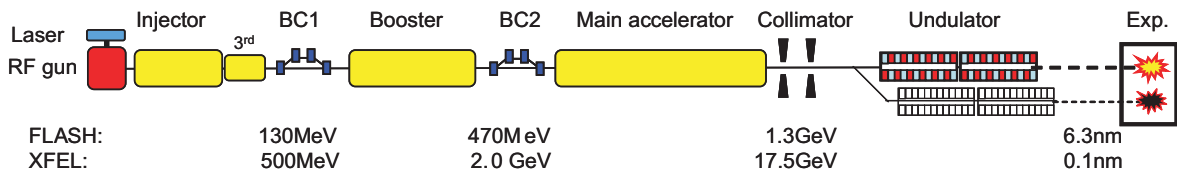

Figure 1: Generic layout of the Free Electron Laser FLASH and the European XFEL.

measured at the cryo-module test stand at DESY. In addition, the coupler of ACC5 has been repaired and module ACC3 has been exchanged, allowing FLASH to reach the design beam energy of 1 GeV or 6 nm photon wavelength.

At the exit of the FLASH linac, space for a seventh acceleration module is foreseen. To meet the user demands for shorter photon wavelength, the installation of ACC7 is planned for 2009. This boosts the beam energy toward 1.3 GeV and allows the users to reach the water window with wavelengths below 4.3 nm in the first FEL harmonics.

This new accelerator module (No. #8) will be assembled at DESY by industry. The four acceleration modules (ACC4-ACC7) correspond to a baseline RF section of the XFEL. It will, therefore, allow for testing of the complete high- and low-power RF control system, as foreseen for the Angstrom machine; this includes the waveguide distribution and 32-cavity field regulation.

3.9 GHz LINEARIZING CAVITIES

Ultra-short FEL pulses of some ten femtosecond duration are produced at FLASH by inhomogeneous electron bunch compression, causing a sharp leading high-peak current spike with a picosecond-long trailing tail. The longitudinal profile is mainly a consequence of the non-linear energy chirp from the time-dependent RF fields and the linear shearing of the longitudinal phase space that occurs in the magnetic bunch compressor chicanes.

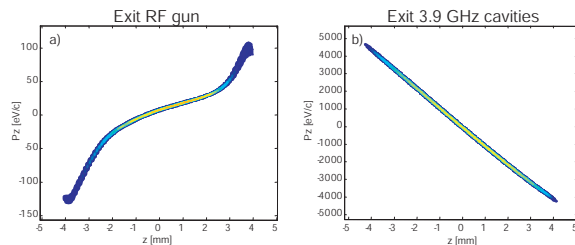

Figure 2: Simulation of longitudinal phase space at the entrance of ACC1 and at the exit of the 3rd linearizer cavities.

Of significant importance for the benchmarking of beam dynamics and operational aspects of the XFEL with homogeneous bunch compression is the installation of the third harmonic superconducting linearizer cavity operated at 3.9 GHz (see Fig. 2(b)).

At FLASH, the first bunch compression takes place at 130 MeV beam energy. Four 3rd harmonic cavities operated at a gradient of 15 MV/m (20 MV voltage total) are X-ray FELs

sufficient to remove non-linearities caused by accelerating RF, time-momentum correlations exiting the RF gun (Fig. 2(a)), higher order chicane momentum compaction (T_{566}) and distortions due to collective effects. The XFEL requires a total voltage of 108 MV at 3.9 GHz due to the higher energy of 500 MeV at the first compressor. The voltage can be achieved by 24 cavities at a gradient of 13.5 MV/m.

Cavity treatments, assembly and vertical performance tests have been successfully carried out at Fermilab [5, 6]. The delivery of a complete cryostat housing the four cavities for FLASH (Fig. 3) by Fermilab is foreseen for Spring 2008 [7]. An integral test of the cryostat is planned at the DESY cryo-module test bench before installation in 2009.

The preservation of the projected beam emittance requires an alignment of the cavities to each other better than 0.5 mm. In addition, a good orbit control through the cavity string is needed.

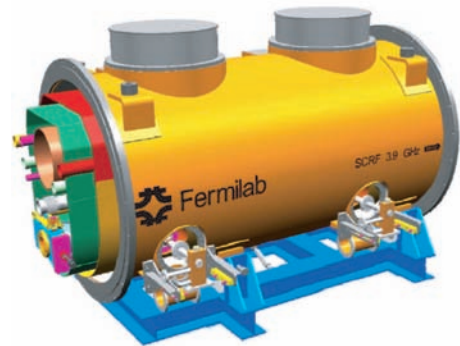

Figure 3: Cryostat housing the four 3rd harmonic cavity for FLASH.

DIAGNOSTICS DEVELOPMENTS

Intra-bunch train feedback

The long duration of the XFEL electron macro-pulses enables active stabilization of the transverse beam offsets by means of a fast intra-bunch-train feedback (IBFB) system. The Paul Scherrer Institute agreed to develop the IBFB which will be tested in its prototype version at the FLASH linac [8, 9].

The proposed IBFB topology, shown in Fig. 4, consists of two upstream beam position monitors (BPM) followed by two kicker magnets for each transverse plane and two downstream BPMs. From position measurements

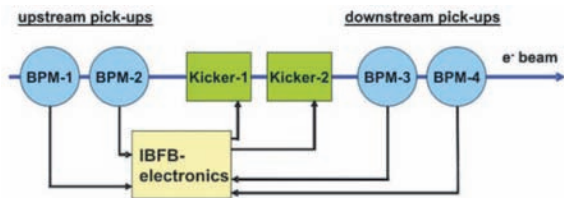

Figure 4: Topology of the intra-bunch train feedback system

of the upstream BPMs transverse kicks are applied with a latency preferably below the bunch spacing of 200 ns and 1000 ns for the XFEL and FLASH. Optimization of the feedback parameters is derived from the downstream BPMs. The proposed IBFB system will damp perturbations up to frequencies of some 100 kHz. The FPGA-based digital IBFB electronics include a DSP that enables adaptive feed-forward correction of repetitive intra-train variations. Resonant stripline pickups were developed to meet the desired orbit resolution of 1-2 μm and latency requirements. A test of the IBFB at FLASH is planned for 2008.

Single-shot THz spectrometry

Coherent radiation produced at diffraction and transition screens or bending magnets provides an excellent opportunity for diagnosing and controlling the bunch compression process. The radiation is emitted mid and far infrared wavelength range, corresponding to the electron bunch length. To measure this radiation, a single-shot THz spectrometer based on three staged diffraction gratings has been developed (see Fig. 5(a))[11, 12]. The diffracted radiation is recorded by an array of pyro-electric sensors (shown in Fig. 5(b)), that can be read out simultaneously. To suppress water absorption in air, the spectrometer and detector unit is housed in a vacuum vessel.

Correlations between the FEL intensity and different wavelengths ranging from 12 μm to 80 μm clearly show that the spectral information reveals significantly more information than a simple integral power determination. For example, the FEL intensity is correlated with the THz intensity at 30 μm , but anti-correlated to wavelengths around 12 μm , indicating a large destructive compression of the beam. The measurements were carried out using a single kicked bunch onto an transition screen. An online device suited for macro-pulse operation that detects the coherent synchrotron radiation emitted at the last bending magnet of the chicane is in preparation.

Fiber laser based electro-optic bunch profiling

The longitudinal bunch profile has been successfully measured by detecting the Coulomb field of the bunch with electro-optics (EO) techniques. The Coulomb field is encoded into the polarization of a broadband laser pulse (Ti:Sa laser) and decoded by transforming the polarization variation into a laser intensity modulation. Cross-X-ray FELs

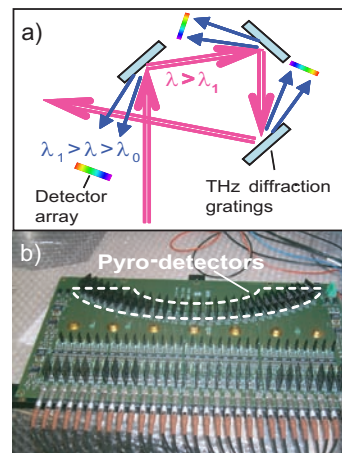

Figure 5: (a) Scheme of single-shot spectrometer covering 12-80 μm radiation. (b) Pyro-detector array with 30 channels.

comparison with a transverse deflecting RF structure turning the longitudinal charge distribution into a transverse streak on an observation screen[10] reveals a time resolution of 60 fs rms, limited by electro-optic crystal [13, 14].

Unlike the transverse deflector, EO-techniques are non-invasive and allow for single-shot detection of all bunches in an macro-pulse. This requires the development of a fast readout system for detection of the laser intensity modulation in a line-array, and, in a second step for intra-train feedbacks, a high speed FPGA based profile processing.

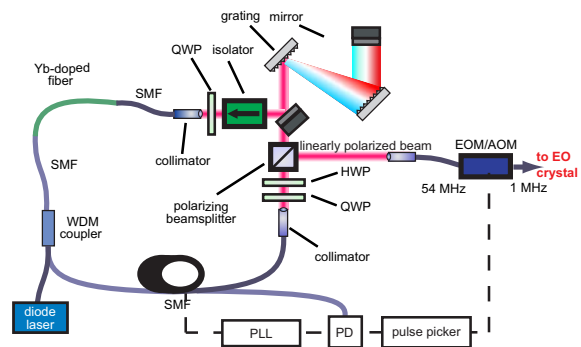

Figure 6: Scheme of Yb-fiber laser for EO bunch profiling.

Suited for tunnel installation and for every day operation, an ultra-broadband Ytterbium-fiber laser, sketched in Fig. 6, is considered. The fiber laser has been developed in corporation with Bilkent Uni. [15]. The repetition frequency of the cavity is 54 MHz and will be reduced with a pulse-picker to match the bunch frequency. Fiber amplification allows for boosting of the pulse energy to 1-10 μJ with pulse durations below 50 fs (FWHM).

Optical replica synthesizer

Femtosecond time-resolutions can be achieved with an optical replica synthesizer (ORS), proposed in Ref. [16]. It

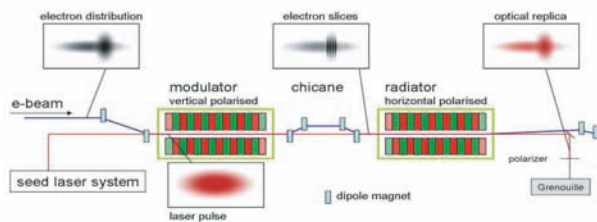

Figure 7: Scheme of optical replica synthesizer.

operates like an optical klystron FEL seeded by an infrared laser (Fig. 7) [17]. In the modulator undulator, the interaction of the laser with electrons causes an energy modulation. A small chicane turns the energy modulation into a density modulation at the wavelength of the laser light. The micro-bunched beam radiates coherently in a radiator undulator. The emitted light pulse with the same longitudinal profile as the electron beam is analyzed by a commercially available second-harmonic generation FROG (frequency resolved optical gating) device.

In a collaboration effort between Uni. Stockholm, Uni. Uppsala, Uni. Hamburg, BESSY and DESY, the ORS experiment was assembled at FLASH. The commissioning of the novel diagnostic device is scheduled for Autumn 2007. Beside the diagnostics aspect, the ORS experiment will provide valuable experience with the design and the operation of a laser heater, as foreseen in the XFEL design.

FEMTOSECOND SYNCHRONIZATION

A drift-free synchronization distribution system with femtosecond accuracy is of key importance for the stability of X-ray FELs and is an indispensable prerequisite for laser seeded FELs. The most critical devices of an FEL are the photo-injector laser, the RF gun, the acceleration section upstream of the bunch compressors, and pump-probe and seed lasers for user experiments. Their locations are separated by 260 m for FLASH and by 3.4 km for the XFEL. Femtosecond accuracy at these large distances cannot be achieved with conventional coaxial RF cable distributions. Laser based synchronization, however, can provide the desired stabilities [18]. At FLASH, a prototype system for the XFEL of a laser based synchronization is under construction [19]. The large complexity of such a system, comprised of multiple feedback loops, needs a careful design of the sub-components and optical devices to meet the reliability, stability and maintainability requirements.

The new synchronization system consists of an passively mode-locked Erbium-doped fiber laser producing ultra-short pulses at central wavelength of 1550 nm and a repetition rate of 216 MHz. The fiber laser is narrow-bandwidth locked to the low-noise RF master oscillator of FLASH. The laser pulses are distributed throughout the facility in dispersion compensated optical length stabilized fiber links. Length stabilization is accomplished by Piezo-transducers. The error signal is generated by the precise X-ray FELs

temporal overlap of pulses exiting the laser with pulses back-reflected at the end of the fiber link in a balanced second harmonic optical cross-correlator. A 400 m long fiber link test bench installed in an accelerator hall has been setup to develop the link stabilization unit. First out-of-loop measurements show a short time (≈ 10 min.) link accuracy of 4.4 fs rms and drifts of 20 fs peak-to-peak during 12 hours are observed. At the same time, the optical fiber length has changed due to environmental temperature change by more than 40 ps [20].

At the link exit, three different front-end systems can be classified: a) the synchronization of optical lasers using sum-frequency optical cross-correlation; b) the direct use of the optical synchronization pulses for sub-50 fs bunch arrival measurements [21], bunch position monitoring in large apertures [22], and RF signal sampling. The optical pulses are also most suited as seeds for laser amplifier, e.g. the ORS-experiment; c) the conversion to RF for the acceleration field control, for example, by means of a Sagnac-loop interferometer [23].

Figure 8 shows the layout of the FLASH optical links and their front-ends. The system will be suited to stabilize the electron beam arrival by fast intra-train feedbacks for the RF control and to synchronize all relevant devices.

LASER SEEDING (S-FLASH)

Implementation of a femtosecond stable synchronization system and further improvements of the RF controls should produce a reduction of the electron timing jitter below 100 fs (FWHM). The 3.9 GHz linearizer cavities allows for longer electron bunches (400 fs FWHM) with uniform peak currents that are comparable to what we use today. This will enable the stable temporal overlap for external seeding of FLASH (s-FLASH) at VUV wavelengths.

A technical feasibility study to demonstrate electron beam seeding with the high harmonics generated by an optical laser impinging on a gas target has been approved by the German funding agency. The goal of s-FLASH is to initially reach saturation at 30 nm seed wavelength (29th harmonics) with 100 kW seed power. The desired FEL intensity fluctuation would be smaller than 5 % at the Gigawatt level, the radiation would have full longitudinal coherence with a SASE background below 1 % and the pump-probe timing would be stable below 10 fs.

To avoid impacts on the normal FLASH user operation, the layout of the experiment (Fig. 9) allows for parasitic operation. The ten meter long, variable-gap undulator will be installed after the collimation dogleg, providing the required wavelength tunability at fixed electron beam energies. The seed is transported from a neighboring laser building and coupled into the electron beam line at the last dogleg bending dipole. The Gigawatt seeded FEL pulses with a duration of about 20 fs FWHM are coupled out a few meters behind the undulator. The out-coupling mirror is located in the center of a small chicane to vertically offset the electron beam by ~ 10 mm. The FEL beam is then

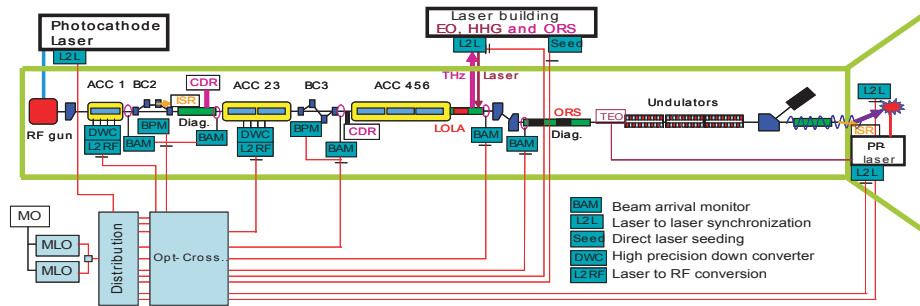

Figure 8: Prototype of a laser based synchronization system for the XFEL at FLASH

transported to an experimental building outside of the accelerator tunnel. A portion of the optical laser is split after the multi-pass amplifier and transported to the pump-probe experiment. Installation of s-FLASH is planned for 2009.

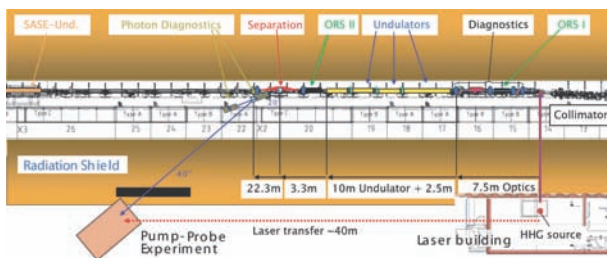

Figure 9: Layout of the laser-seed FLASH (s-FLASH).

SUMMARY

Future upgrades of FLASH will provide important opportunities for prototyping XFEL components such as a complete RF section, the 3rd harmonic cavity, novel diagnostics for beam stabilization, a synchronization system with femtosecond accuracy, and an external seeding system.

REFERENCES

[1] V. Ayvazyan et al., "First operation of a free-electron laser generating GW power radiation at 32 nm wavelength", *Eur. Phys. J. D* 37, p. 297-303 (2006)

[2] W. Ackermann, et al., "Operation of a free-electron laser from the extreme ultraviolet to the water window", *Nature Photonics* 1, 336 - 342 (2007)

[3] J. Rossbach, "A VUV Free Electron Laser at the TESLA Test Facility at DESY", *NIM A* 375, (1996) 269.

[4] "XFEL Technical Design Report", DESY 2006-097, <http://xfel.desy.de>.

[5] T. Khabiboulline, et al., "3.9 GHz Superconducting Accelerating 9-cell Cavity Vertical Test Results", *PAC'07*, June 2007, Albuquerque, USA, p. 2295

[6] E. Harms, et al., "Status of the 3.9-GHz Superconducting RF Cavity Technology at Fermilab", *PAC'07*, June 2007, Albuquerque, USA, p. 2256

[7] Private communication E. Vogel, DESY

[8] V. Schlott, et al., "Intra Bunch Train Feedback for the European X-FEL", *EPAC'06*, Edinburgh, Scotland, p. 3017

[9] B. Keil, et al., "Design of an Intra-Bunch-Train Feedback system for the European X-ray FEL", *DIPAC'07*, May 2007, Venice, Italy

[10] M. Huning, et al., *FEL'05*, Aug. 2005, Stanford, CA, p. 538.

[11] H. Delsim-Hashemi et al., "Single-Shot Longitudinal Diagnostics with THz radiation at the Free-Electron Laser FLASH", *FEL'06*, Aug. 2006, Berlin, Germany, p. 594

[12] B. Schmidt, "Overview on diagnostics for X- and XUV-FEL", *FEL'06*, Aug. 2006, Berlin, Germany, p. 761

[13] G. Berden, et al., "Benchmarking ultrafast electron bunch length monitors", accepted for publication, *Phys. Rev. Lett.*

[14] B. Steffen, et al., "Single-Shot Longitudinal Bunch Profile Measurements at FLASH Using Electro-Optic Detection", this conference, WEBAU04.

[15] A. Winter, O. Ilday and B. Steffen, "Femtosecond Yb-doped fiber laser system at 1 μm of wavelength with 100-nm bandwidth", *DIPAC'07*, May 2007, Venice, Italy

[16] E. Saldin, E. Schneidmiller, M. Yurkov, "A simple method for the determination of the structure of ultrashort relativistic electron bunches", *NIM A* 539 (2005) 499.

[17] G. Angelova, et al., "Installation of the Optical Replica Synthesizer in FLASH", this conference.

[18] J. W. Kim, et al., "Large scale timing distribution and RF synchronization for FEL facilities", *FEL'04*, Trieste, Italy.

[19] A. Winter, et al., "High-precision laser master oscillators for optical timing distribution systems in future light sources", *EPAC'06*, July 2006, Edinburgh, Scotland, p. 2747.

[20] F. Loehl, et al., "Sub-10 Femtosecond Stabilization of a Fiber Link Using a Balanced Optical Cross Correlator", *PAC'07*, June 2007, Albuquerque, USA, p. 3804

[21] F. Loehl, et al., "A Sub-50 fs Bunch Arrival Time Monitor System for FLASH" *DIPAC'07*, Venice, Italy, 2007.

[22] K. Hacker, et al., "Large Horizontal Aperture BPM for use in Dispersive Sections of Magnetic Chicanes", *EPAC'06*, July 2006, Edinburgh, Scotland, p. 1043.

[23] J. W. Kim, et al., "Long-Term Stable Microwave Signal Extraction from Mode-Locked Lasers", *Optics Express*, July 2007, Vol. 15, Issue 14, p. 8951