

# Beam Position Monitor With the Digital Signal Processing

A.Batrakov, T.Bolshakov, E.Levichev, V.Sajaev, V.Shilo, V.Smaluk  
Budker Institute of Nuclear Physics, 630090 Novosibirsk, Russia,  
S.Kuznetsov  
KSRS, Kurchatov Institute, 123182 Moscow, Russia

## Abstract

A new electronics for beam position monitor (BPM) that was developed and tested at VEPP-4M storage ring is described. A single module includes 4-channel ADC and DSP TMS320 that can be connected via serial data link with a central processor board. 10 bits ADCs are simultaneously synchronized and have maximum sample rate 15 MSPS. DSP provides the possibility of digital processing of information according to the algorithms loaded from the central processor. Specifications of several operation modes and their examples at the beam of VEPP-4M are presented.

## 1 INTRODUCTION

To stabilize the transverse beam oscillations at VEPP-4M in the frequency range of 3-100 Hz by means of digital feedback system, a new BMP electronic module based on DSP was designed and tested. It takes analog signals from existing turn-by-turn pickup station of VEPP-4M described in [3]. Besides the primary goal, the developed instrumentation may be used as a powerful diagnostic tool to study a wide range of the accelerator phenomena on the base of turn-by-turn measurements. A fast DSP permits to process the measured information (intensity or coordinates) with the algorithm loaded from central computer.

In this paper we are concentrating on the potential application of the new BPM electronic module to registrate the different beam dynamics effects regardless the detailed description of the observing pictures. The coherent transverse beam oscillations can be excited by many processes. It can be external electromagnetic kick to explore a non-linear dynamics and dynamic aperture [1], or mismatching in transverse position, slope, energy or phase during injection [2], coherent instabilities, seismic beam vibrations, ion accumulation, coupling between longitudinal and transverse oscillations in the dispersion region etc. All these processes can be investigated with the instrumentation described below. Two approaches are considered: time domain approach when the beam current or displacement depend on the revolution number are under study and frequency domain approach when the FFT is applied to the initial coordinate array. The number of the examples cover (a) simple turn-by-turn measurements, (b) averaging procedure which provides frequency downsampling and investigation of slow effects up to COD measurements, (c) harmonic analysis and time-frequency scanning diagnostic

mode.

## 2 DIGITAL SIGNAL PROCESSING

The "intelligent" BPM controller is based on the TMS320C31-40 Texas Instruments floating point DSP. Structure of the controller is shown in fig.1. The DSP has 32 KWords of local static memory and 32 KWords of dual ported memory (DPM). Both memories have access time 50ns. DPM is shared by the processor and ADCs. DPM

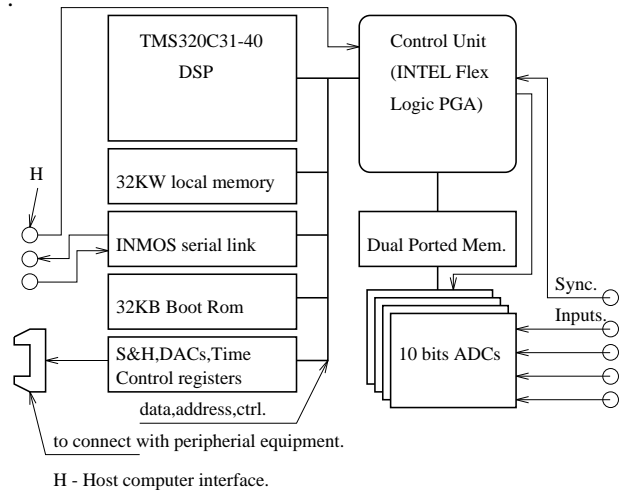

Figure 1: Structure of the DSP controller.

using allows ADC write the data directly to the processor address space. This fact enables to use the ADCs data without additional time penalty for its moving. Peripheral registers to control the external board with programmable delay generator, DACs, sample and hold are mapped into the DSP address space. 64 kbyte ROM contains the primary boot-loader and some application codes. These codes can be loaded into local memory during program execution. All on-board devices are managed by dedicated control unit, implemented inside INTEL Flex Logic PGA. The hardware interrupts are used by DSP to synchronize the application software with external events. Interrupts when ADC's have data for writing to DPM and when DPM is full are possible.

10 bits ADCs with common simultaneous synchronization and maximum sample rate 15 MSPS are installed on the small piggy-back module at the moment. The ADC's data is shifted left to 6 bits for every channel: most significant bit of the ADC word is DSP's data bit 15 (from bit

0). All other bits are hardware zeroed when data write cycle from ADCs into DPM take place on the bus. Less significant bits are reserved to increase ADC's resolution in future without software modification. Control unit drives the DPM address bus during write process of ADC's data to DPM.

INMOS serial link interface IMSC012 is used to provide I/O functions with host computer and codes downloading with physical data rate - 10 or 20 Mbit/sec. All signals can be transmitted/received up to distance 200 meters via 50 Ohm coaxial using home-made interface. Link speed for this distance is 10 Mbit/sec. Choice of the INMOS serial data interfaces allows using the transputer host software to load DSPs and to implement host I/O functions without development of the additional host hardware/software.

### 3 MEASUREMENT EXAMPLES

#### Turn-by-turn measurement

In this mode, a new electronic instrumentation is equivalent to that installed at VEPP-4M earlier. The digitized signals from BPM (four button-type electrodes) are recorded for 8192 revolutions and stored in DSP memory. In turn-by-turn mode the measured rms resolution for beam position is equal to  $\sigma_{x,z} \simeq 70\mu\text{m}$ . The performance of this mode is described in detail in [2] and [1]. Here we just present several examples obtained with the new BPM module.

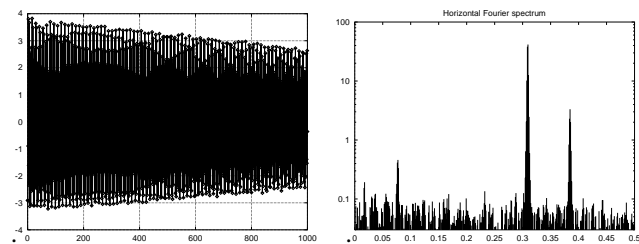

Figure 2: An example of beam motion and its spectrum after horizontal kick, 1000 turns

Fig.2 displays the sampled signal as a function of revolution number and its discrete Fourier transform after the beam was excited horizontally by fast kicker. This data array let us to explore the nonlinear phase space (Fig.3) and amplitude dependent tune shift. Turn-by-turn measurement both of the beam intensity and coordinates make it possible to investigate the beam loss at the border of the stable motion (dynamic or physical aperture). As an example, Fig.4 shows two pictures of particle loss when the beam was kicked to the large amplitude. The left figure corresponds to the dynamic aperture while the right figure demonstrates the beam loss on the physical aperture (movable scraper).

Other sources of the beam coherent oscillation can be investigated by this technique too. Two examples we present here. Fig.5 shows the beam motion excited by the injection mismatching. Having such results it is possible to adjust the injection conditions in order to obtain a large single shot current. One more example concerns the beam coher-

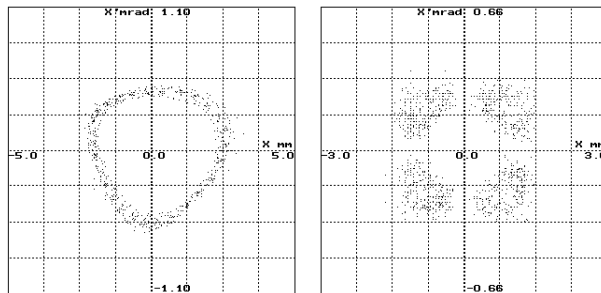

Figure 3: An example of measured phase space. Left plot presents oscillations near  $3\nu_x = 26$  resonance while right one demonstrates motion inside separatrix of resonance  $4\nu_x = 35$ .

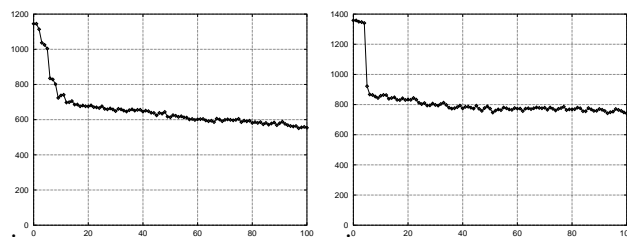

Figure 4: Particle loss when the beam was kicked to the large amplitude. The loss behavior allows to distinguish whether the dynamic or physical aperture causes the loss. Left plot corresponds to the dynamic aperture while the right figure shows the beam loss on the physical aperture.

ent instability due to the electromagnetic interaction with vacuum chamber (Fig.6).

#### Averaging

The averaging algorithm can be foreseen and downloaded to the DSP board. Two goals are achieved by means of averaging. First, the signal is downsampled providing the study of relatively slow beam effects. Second, any reading noise may reduce increasing the number of averages until a

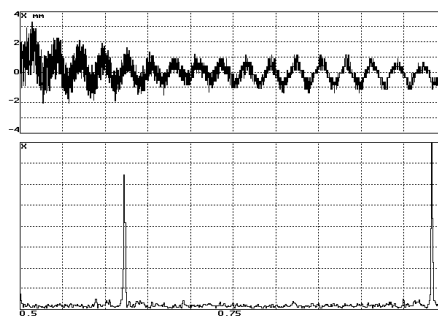

Figure 5: Residual beam motion after injection. The motion demonstrates a combination of the betatron and synchrotron oscillations. The spectrum shows these frequencies. 1000 turns

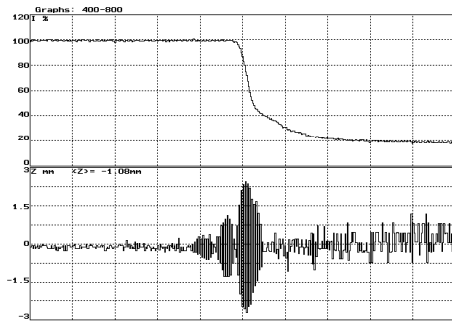

Figure 6: Vertical coherent instability. Upper plot shows beam current, lower plot demonstrates vertical beam motion. The plot length is 400 turns

good resolution is obtained. The averaging method is used in ELETTRA BPM system [4]. The averaging algorithm allows also calculate the rms deviation of the reading and find the best averaging number. Fig.7 demonstrates the resolution improvement while the number of averages is grew up.

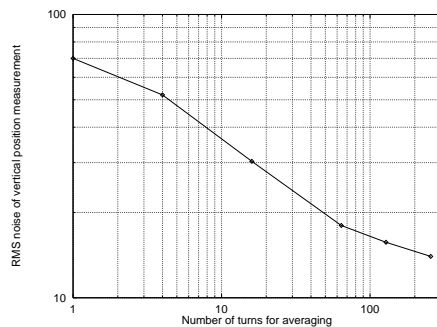

Figure 7: Resolution improvement due to number of averages increasing.

In Fig.8 the example of low frequency signal is shown. The beam oscillations are driven by the ground motion. The FFT spectrum shows 6 Hz harmonic due to the seismic vibration and harmonics of 50 Hz due to the main power supply.

#### Fast Q-measurement (the nearest plans)

A fast DSP can be successfully used to perform Q-measurement and spectral analysis in accelerator. The flexibility of the system allows to perform a series of Q-measurements. FFT can be moved over the data by a user-defined step to generate a "spectrum movie" and see dynamic processes in the electron beam [5]. This method can be useful to explore the tune shift during the fast ramping in a synchrotron, coherent instabilities, ions accumulation, etc.

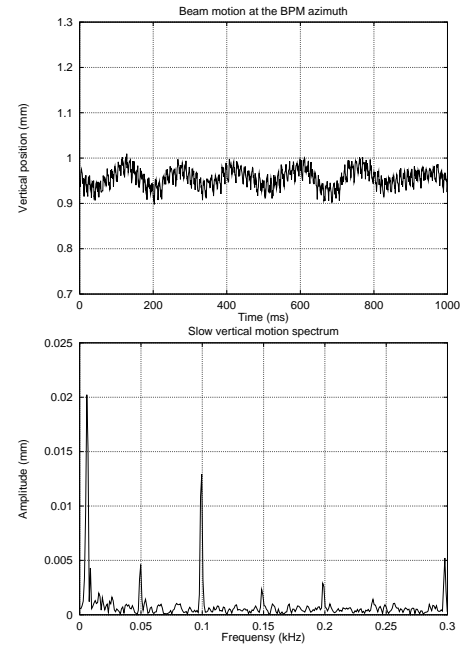

Figure 8: Slow beam motion caused by seismic vibrations and power supply ripple. Spectrum shows 6 Hz seismic harmonic and harmonics of power supply.

## 4 CONCLUSION

Turn-by-turn measurements together with fast DSP provide the enhancement of beam diagnostic performance and permit to study wide range of beam dynamics effects: fast coherent beam motion including nonlinear oscillations and transverse instabilities, relatively slow longitudinal instabilities and very slow motion due to seismic vibrations and power supply ripple. Two approaches always can be used: time domain and frequency approaches.

## 5 REFERENCES

- [1] V.Kiselev et al. A non-linear beam dynamics experiments at VEPP-4M ring. These proceedings.
- [2] A.Kalinin et al. Applications of beam diagnostic system at the VEPP-4 complex. These proceedings.
- [3] A.Kalinin et al. A beam diagnostic system for storage rings. These proceedings.
- [4] R.De Monte et al. Elettra BPM System (Hardware and Software); first results.- Proc.of the EPAC'94, V.2, pp.1530-1532.
- [5] J.Gonzalez et al. Fast Q-measurement for the PS by FFT Analysis.- Proc.of the EPAC'94, V.2, pp.1734-1736.