

# BEAM EXTRACTION SYSTEMS OF THE VINCY CYCLOTRON

O. Borisov

Joint Institute for Nuclear Research, 141980 Dubna, Moscow reg., Russia

J. Ristic-Durovic

VINCA Institute of Nuclear Sciences, P.O.Box 522, 11001 Belgrade, Yugoslavia

## Abstract

It has been decided to use two extraction system for the VINCY Cyclotron [1] with the same extraction direction: the foil stripping system as the main, and the electrostatic deflection system as the additional extraction system. For both systems, calculations for test beams have been performed to decide upon the positions of the stripping foil, position and parameters of the electrostatic deflector and number, positions and parameters of necessary correction and focusing magnetic channels.

## 1 INTRODUCTION

For both extraction schemes several sets of calculations were performed. Magnetic field data used in calculation, take into account measurements on the model-magnet. Fig.1 shows the test particle trajectories as for extraction by stripping and for one by electrostatic deflector. The co-ordinates of the point at which all extracted beams should meet, are set to  $R = 200$  cm,  $\Theta = 275^\circ$ . The adjustment of extracted trajectories direction after this point is being realized with the correction magnet.

## 2 EXTRACTION BY STRIPPING

Extraction by stripping can be used both for the light and heavy ions [2]. Three types of ions were used in the numerical simulation of the extraction by stripping corresponding to the three levels of the magnetic field:  $H^-$  ( $\eta = 1$ );  $D^-$  ( $\eta = 0.5$ );  $Xe_{132}^{+20}$  ( $\eta = 0.15$ ). The calculations show, that it is possible to realize an extraction of  $H^-$  - ions with energy range  $W=53\div 66$  MeV,  $D^-$  - ions of  $W = 21\div 30$  MeV/nucl and

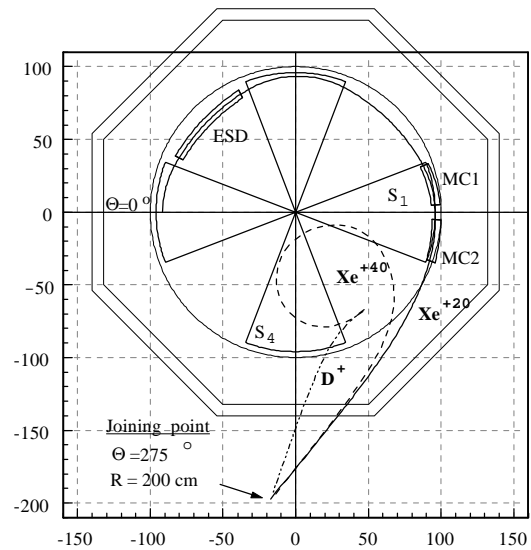

Fig.1 Test particle trajectories as for extraction by stripping and for one by electrostatic deflector.

$Xe_{132}^{+20}$  - ions whose energy is 3.1 MeV/nucl in the desired direction. Fig.2 shows necessary foil positions in  $(\Theta, R)$  co-ordinate system for the specified joining point.

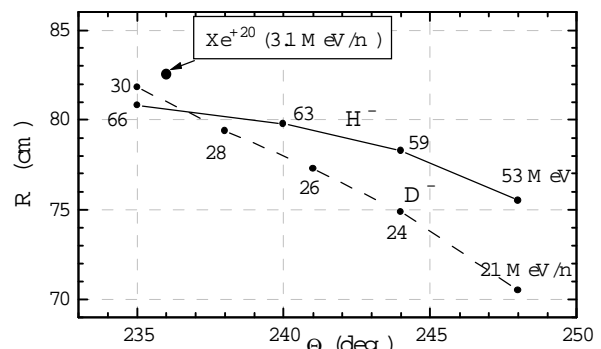

Fig.2 Stripping foil positions in  $(\Theta, R)$  co-ordinate system.

The output ion trajectories pass through the joining point but have different directions. For  $D^+$  ions with different energies the angle between the beam direction and the central line of sector S4 ranges from  $\gamma = 8^\circ$  to  $19^\circ$ , for

the  $H^+$  ions the range of  $\gamma$  being  $12 \div 19^\circ$ . For the rest of the ions this angle is practically constant and is equal to  $\gamma \approx 39^\circ$ . Since the largest angle between directions of different ion trajectories is  $32^\circ$ , a correction is needed to change the beam direction in the range of  $\pm 16^\circ$ .

To study, not only single ion trajectory, but the behaviour of the beam, radial and axial emittances ( $\epsilon_R = 7.5\pi$  mm mrad,  $\epsilon_z = 2.5\pi$  mm mrad), and energy spread ( $\delta W = 2\%$ ), have been used. These parameters have been obtained from the beam dynamic simulation in the acceleration region.

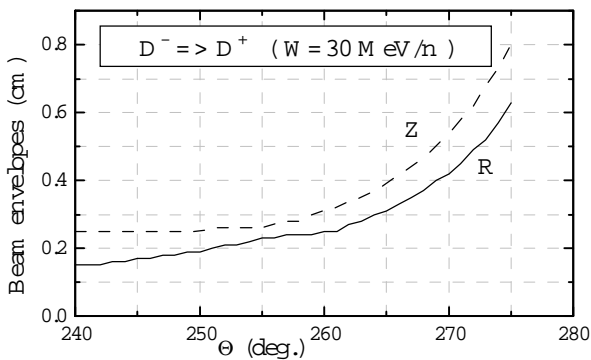

Fig.3 Radial and axial envelopes for the  $D^+$  ion beam.

For  $H^+$  and  $D^+$  ions with different energies the beam dimension in horizontal as well as in vertical direction is of the order of  $1.5 \div 2.0$  cm. Beam envelopes for the  $D^+$  ion beam with 30 MeV/nucleon energy are shown in Fig.3..

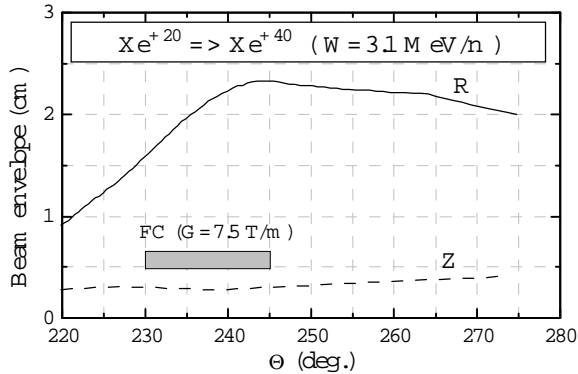

Fig.4 Radial and axial envelopes for the  $^{132}\text{Xe}^{+40}$  beam.

Beam simulation for other types of ions showed that radial focusing channel needs to be used. Since extracted beam directions for all these ions are practically equal after  $\Theta \approx 240^\circ$  it is suggested to use single focusing channel which could be moved within the range of several centimeters. Beam envelopes for the  $Xe_{132}^{+40}$  ion beam with 3.1 MeV/nucleon energy is shown in Fig.4. Focusing magnetic channel with magnetic field gradient

$G = 7.5$  T/m is used in this case. The channel position is in the range  $\Theta = 230 \div 245^\circ$ ,  $R = 101 \div 119$  cm. The radial and axial beam sizes are of the order of  $2 \div 4$  cm. The analysis of the beam envelopes showed that the horizontal aperture of the focusing channel should be  $\approx 5$  cm.

### 3 ELECTROSTATIC DEFLECTION SYSTEM

To extract ions that can not be extracted by stripping, it has been suggested to use extraction system with electrostatic deflector. To successfully design such system one needs to solve two problems: separation of the beam turns at the deflector entrance and extraction of the beam from the accelerator chamber.

Study of the beam dynamics just before the extraction region during the design of the cyclotron parameters showed that the orbit separation in the extraction region is of the order of  $1.5 \div 3.0$  mm for different ions. To effectively use an electrostatic deflector for the beam extraction, orbit separation needs to be enlarged. Introduction of the harmonic of the magnetic field of the order of  $20 \div 30$  Gauss at the extraction radius can cause orbit separation to increase to  $4 \div 6$  mm.

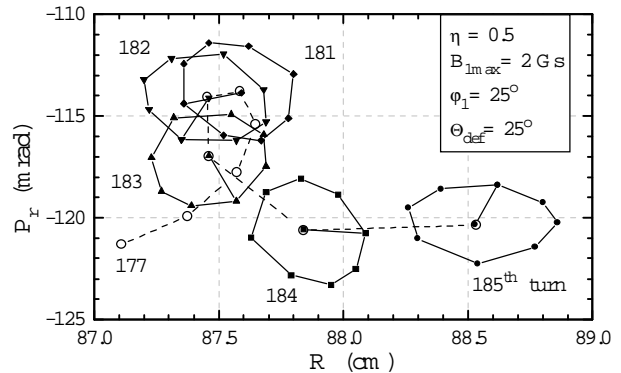

Fig.5 Radial emittances during last several turns.

The second method is based on the effect of the  $\nu_R = 1$  resonance combined with the value of the  $2 \div 3$  Gauss for the first harmonic of the magnetic field [3]. Beam is being shifted when  $\nu_R < 1$ . Fig.5 shows the behaviour of the radial emittance during last several turns at the azimuth of the deflector entrance. This separation is achieved at the radius, which is several centimeters larger than it was for the case with orbit separation caused by the first harmonic itself. This simplifies further deflection of the beam and somewhat enlarges the energy of the extracted beam. However, this method has some disadvantages. Last few turns of accelerated orbit are now in the rapidly decreasing edge magnetic field which causes phase shift of the beam that needs to

be compensated by the magnetic field correction. The second problem arises from the  $v_R = 2v_Z$  resonance which may trigger axial oscillations. So it may be necessary to adjust edge magnetic field.

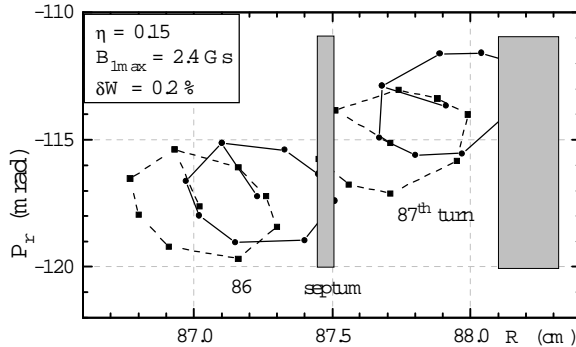

Fig.6 Radial emittances for the last two turns at the azimuth of the deflector entrance.

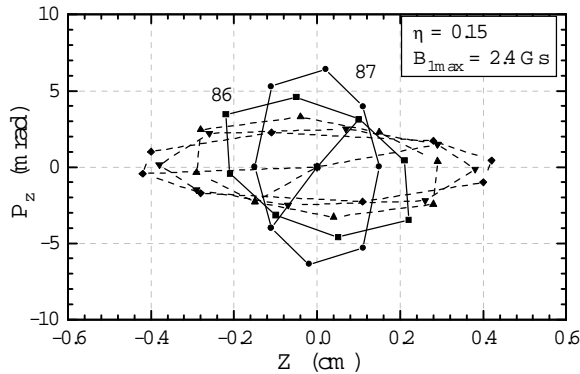

Fig.7 Axial emittances for the last few turns.

In the simulation of the beam behaviour for this case it was assumed that initial radial and axial emittances  $\epsilon_R = \epsilon_Z = 6\pi$  mm mrad, energy spread ( $\delta W = 0.2\%$ ). Fig.6 shows the radial emittances for the last two turns with energy spread at the azimuth of the deflector entrance. Orbit separation without energy spread is of the order of 6 mm. Fig.7 shows the behaviour of the axial emittances for this case.

For beam extraction to the same direction as e set for the foil stripping system is used electrostatic deflector (ESD) placing in the free valley with azimuthal spread of  $40^\circ$  and the deflecting electric field of  $100 \div 120$  kV/cm. Since the extracted beam is passing through the edge magnetic field, radial defocusing is to be expected. Fig.1 shows the extraction trajectory and positions of the extraction system elements. Investigation of beam envelopes showed necessity to have three focusing elements: magnetic channels MC1 and MC2, and focusing channel FC. Fig.8 shows horizontal and vertical envelopes for  $Xe_{132}^{+20}$  beam for the following focusing parameters of magnetic channels: 20 T/m (MC1 and MC2) and 7.5 T/m (FC). The conclusion was that radial and axial beam sizes are of the order of  $2 \div 3$  cm.

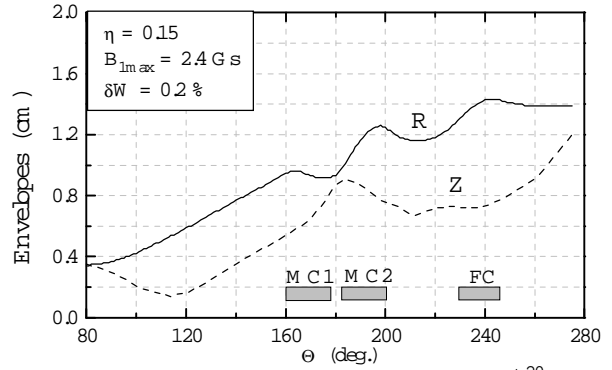

Fig.8 Radial and axial envelopes for the  $^{132}Xe^{+20}$  beam.

## 4 CONCLUSIONS

Calculations have been performed for two extraction systems of the VINCY Cyclotron with the same extraction direction: the foil stripping system as the main and the electrostatic deflection system as the additional extraction system [4]. For both systems calculations for test beam have been performed to decide upon the positions of the stripping foils, positions and characteristics of the electrostatic deflector and number, positions and characteristics of necessary correction and focusing magnetic channels. The joining point of extracted beams has been chosen to be at  $R = 200$  cm,  $\Theta = 275^\circ$ , and the direction of the extracted beam is established such that it forms angle  $\gamma = 24^\circ$  with the axis of sector S4.

## 5 REFERENCES

- [1] N. Neskovic et al. "Tesla accelerator installation" Proc. of EPAC-92, Berlin, v.1, p.415.
- [2] I. A. Shelaev et al. JINR N9-3988, Dubna, 1968.
- [3] M. M. Gordon IEEE NS-13, N.4, p 48, 1966.
- [4] O. N. Borisov, Internal Reports 1-4, 1995.