



Ionization Profile Monitoring at the Tevatron

Andreas Jansson

K.Bowie, T.Fitzpatrick, R.Kwarciany,
C.Lundberg, D.Slimmer, L.Valerio, J.Zagel
Fermilab

Also thanks to:

T.Anderson, M.Bowden, A.Bross, A. Chen, R.Dysert, S.McCormick, S. Suleimani, H.Nguyen, C.Rivetta,
H.Glass, D.Harding, B.Hively, V. Kashikin, D.Miller, Z.Tang, J.Volk, T.Zimmermann, ...



Talk Outline

- Instrument Design
- First beam results
- Results after recent shutdown



Goal

GOAL:

Measure protons and pbar beam size turn by turn at injection and ramp to diagnose and mitigate emittance blow-up.



Challenges in the Tevatron

Challenge:

- Two small beams separated by helix.
- Separate protons from pbars, injected from circulating beam
- Beam induced parasitic signals.
- Low vacuum pressure

Solutions:

- Fine granularity and many channels
- Single bunch resolution and gating
- Improved shielding and matched cables
- Local pressure bump with controlled leak



IPM detector

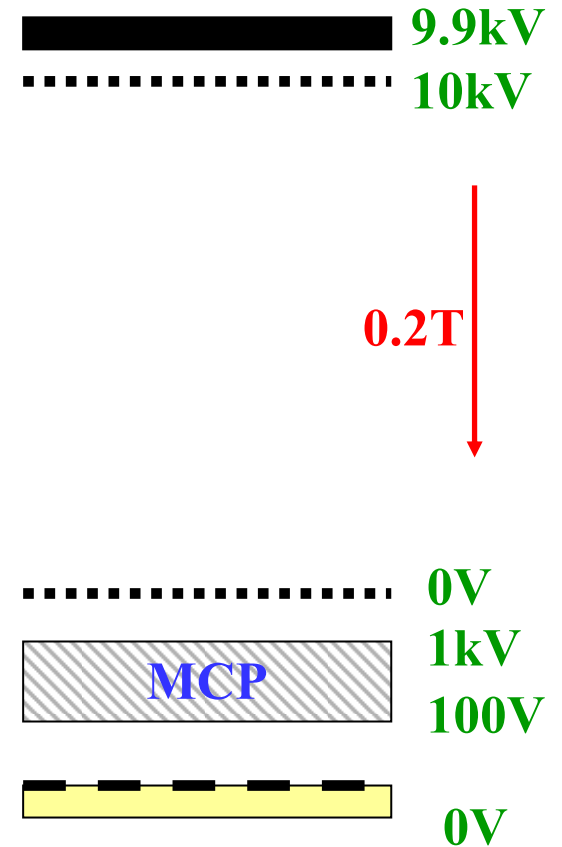
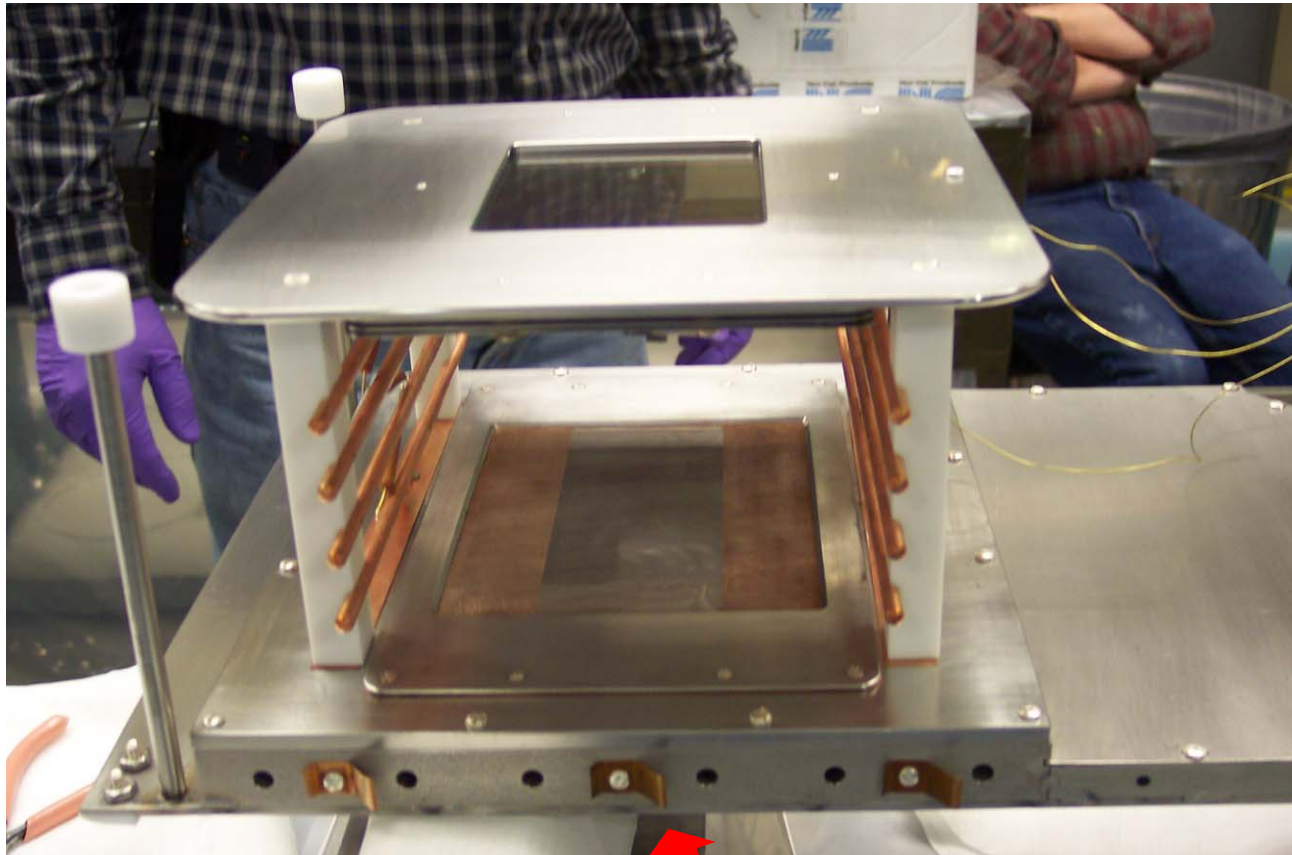

All signal cables are enclosed in a Faraday cage!



Anode board

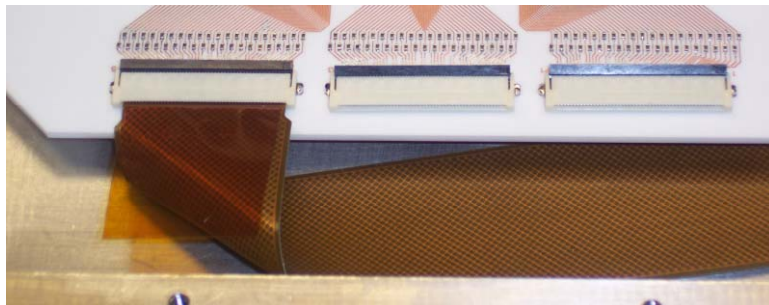
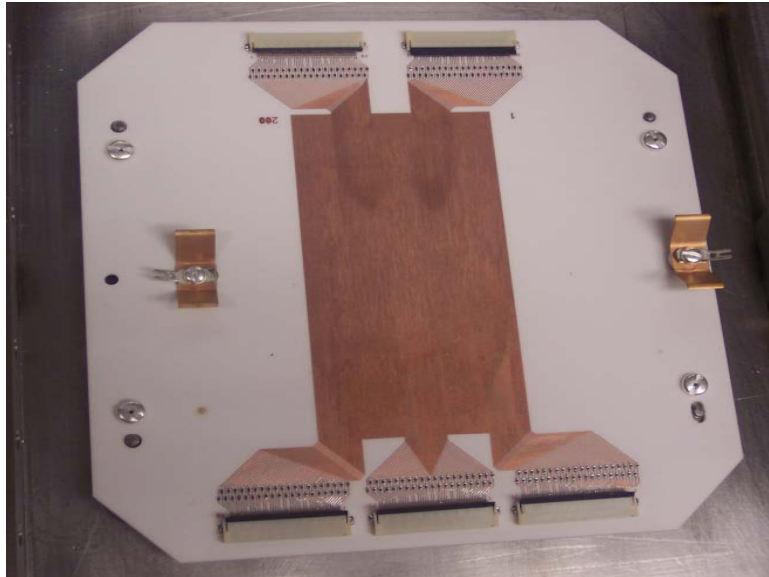

- $\frac{1}{4}$ mm strip pitch
- 200 channels (128 instrumented)
- Board mounted series resistor for back-termination and LP filtering.
- In-vacuum signal cabling using UHV-compatible flex-circuits
- High resolution area can be moved by swapping connectors



Microchannel plate

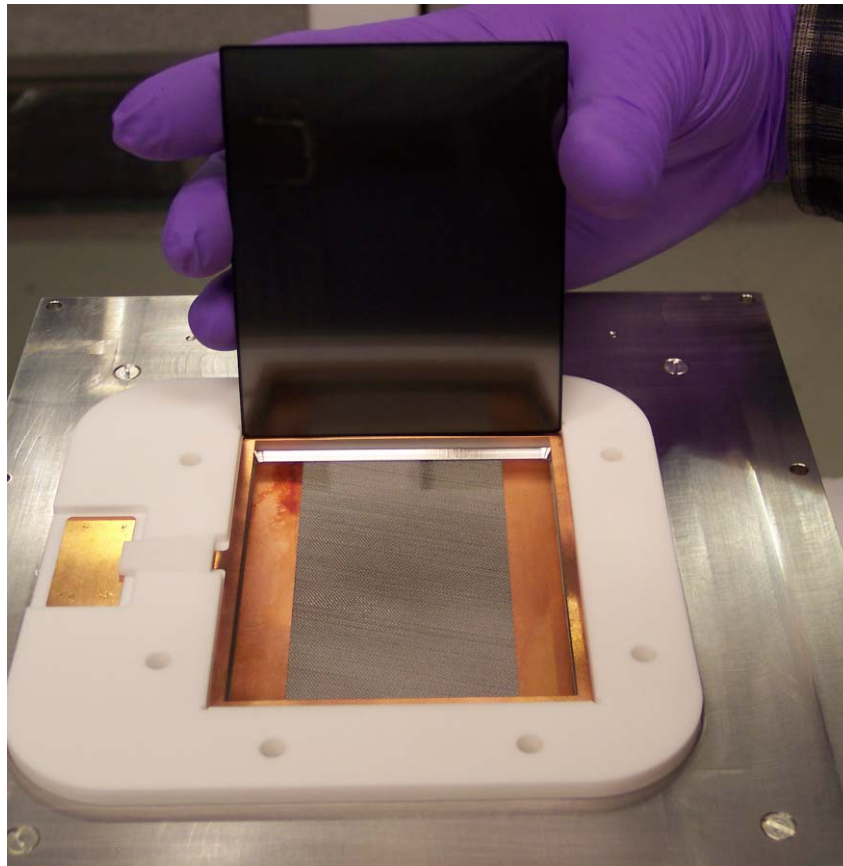

- Max gain with 36 proton bunches is $\sim 1e4$ to avoid saturation.
- Can be achieved with single plate
- With dual plates, each plate would run at a very low gain and low bias current.
- Use single MCP with extra-high bias current.



Detector installation

**Magnets,
vacuum
chambers etc
installed during
2004 shutdown.**

**First detector
installed
December 2005.**

**Both detectors
(re)installed
spring 2006
shutdown.**

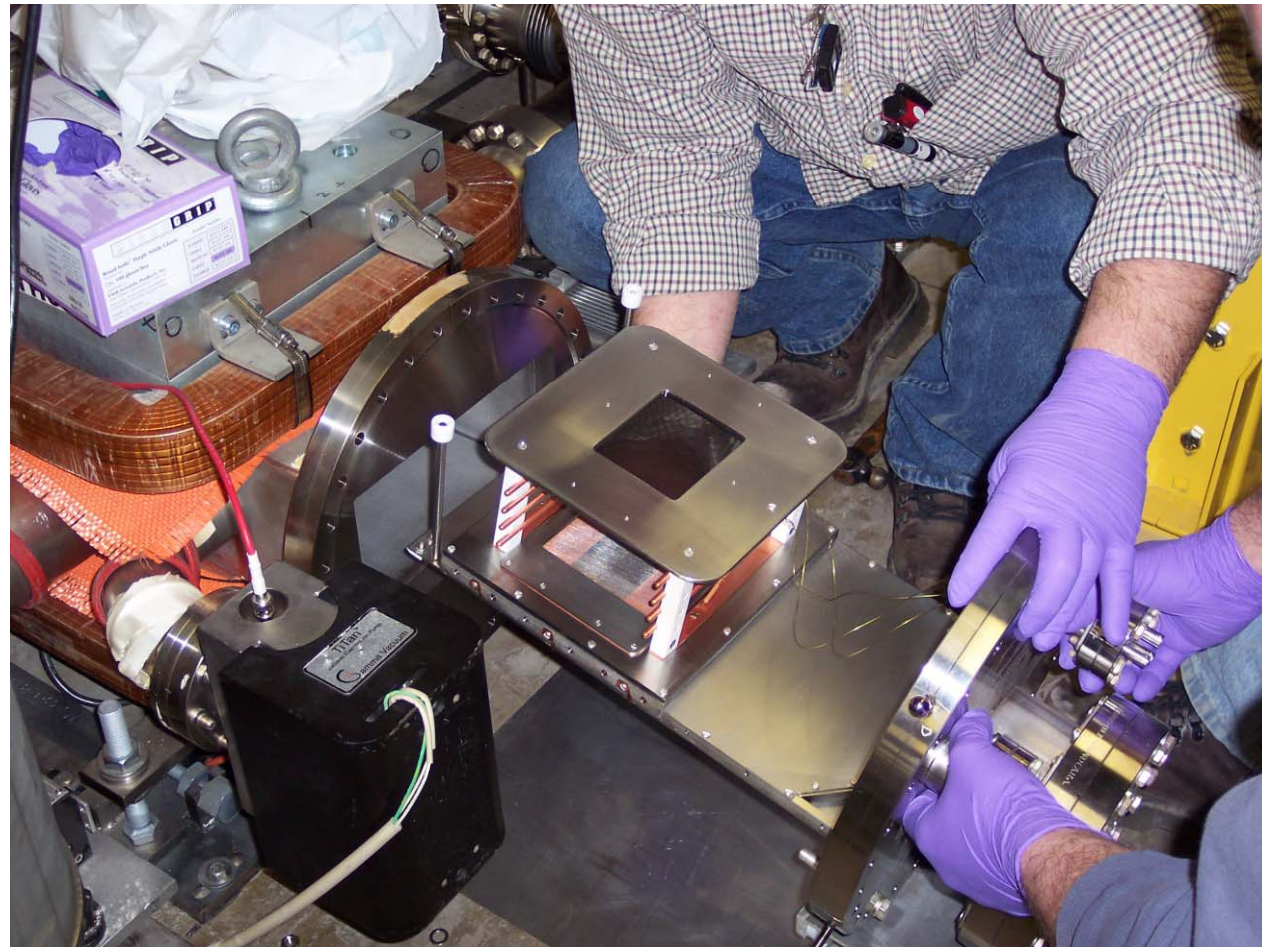

DAQ system

- CMS-QI E chip digitizes signal in tunnel.
- Serial data uplink on optical fiber.
- Receiver and data buffer in upstairs PC
- Timing + QI E clock + QI E clock supplied from PC thru cat-5E cable

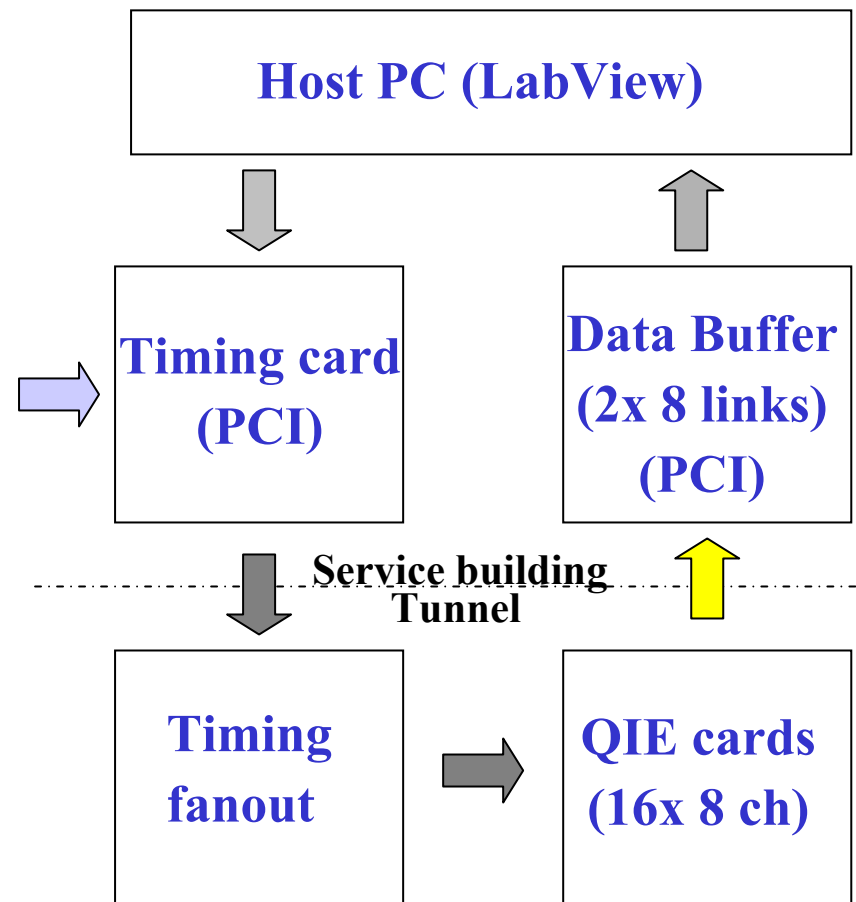

Fermilab QIE8 ASIC

- Charge Integrating Encoder (QIE) developed at Fermilab. Used by KTeV, CDF, Minos, CMS...
- Frequency range 7-53 MHz
- Essentially no deadtime.
- LSB 2.6fC (16000e) in logarithmic mode, 0.9fC (6000e) in linear mode
- Dynamic range $>10^4$ in logarithmic mode
- Noise of O(1fC)
- Radiation "tolerant"

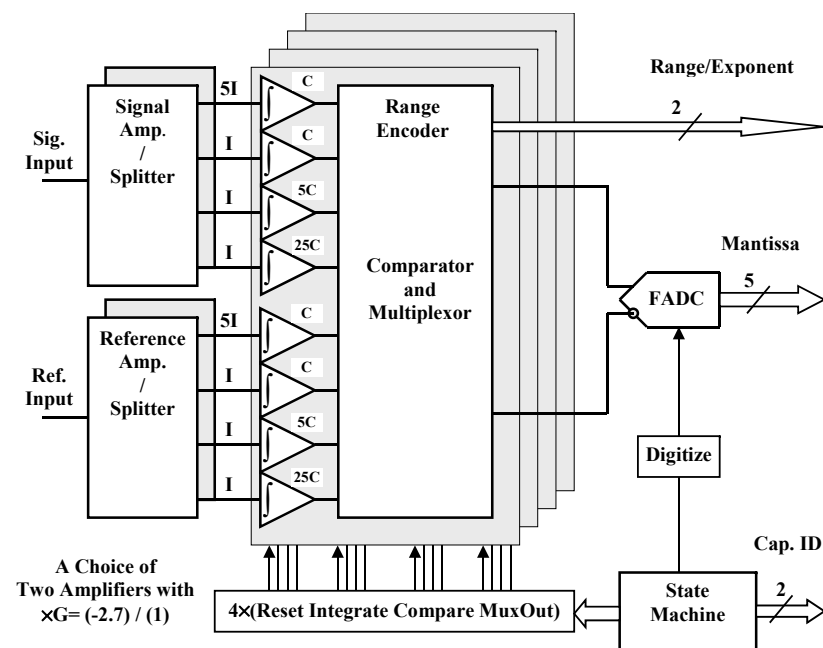

design: T. Zimmerman



QIE card

- 8 channels (CMS QI E8) per board.
- Achieved noise $\sim 1.8\text{fC}$ with 4' cable.
- Data is combined with timing information, serialized by CERN GOL ASIC (rad hard) and sent thru optical fiber at 1.1Gbps data rate
- Timing fanout board cleans up and distributes clock and timing signals

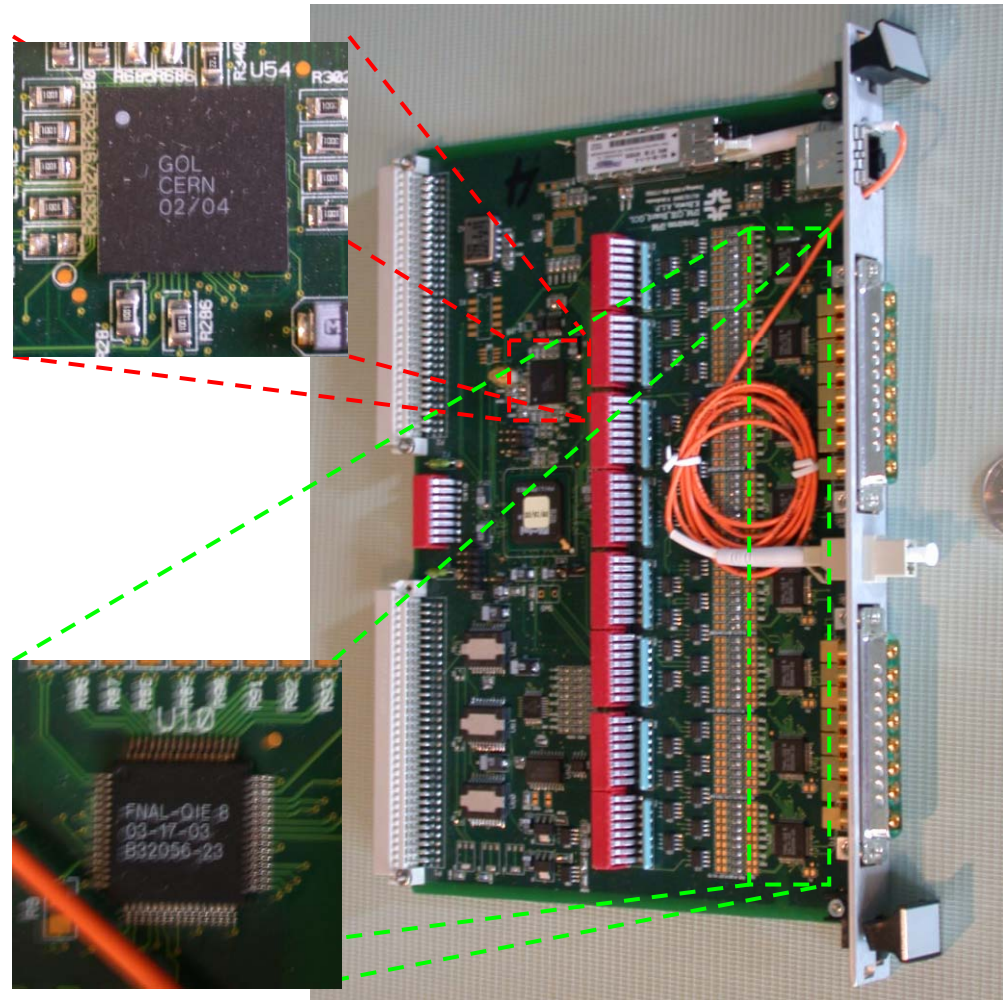

Data buffer card

- Handles 8 incoming optical links (64 channels, 1.1 GB/s of data)
- Can sparsify data on-the-fly based on timing masks
- 512MB RAM allows for
 - 20.000 turns of continuous data
 - 90.000 turns for 72 bunches
 - 6 million turns for a single bunch
- Read out thru PCI 64 bus.
- Two boards are used to handle 128 channels.



- IPM buffer board doubled as prototype for BTeV L1 data buffer.
- Considered for use in MICE experiment.



Timing card

- Produces the 15MHz (2/7 RF) QI E clock
- Decodes and transmits beamsync revolution marker + injection and trigger events
- Controls QI E settings.

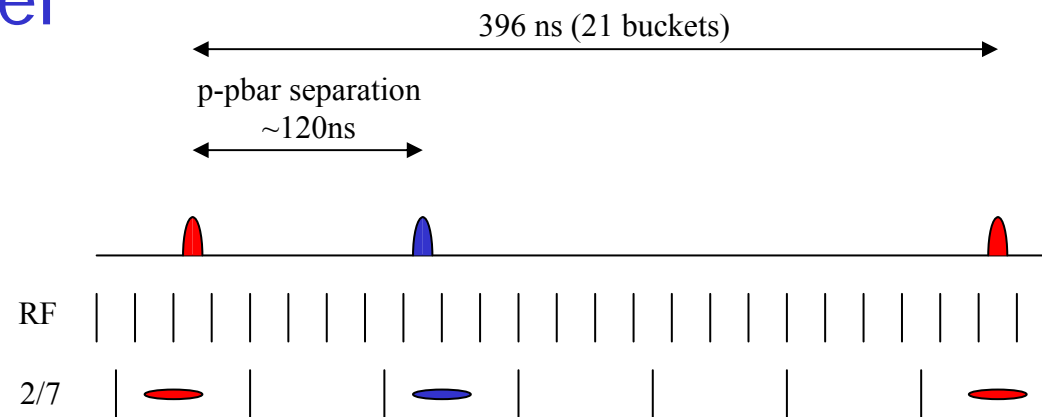

Setup for initial tests

- 2005 shutdown moved to 2006
- Took advantage of magnet failure to install the vertical detector in Dec '05.
- Test DAQ system with 40 channels, 1cm active width, single buffer board

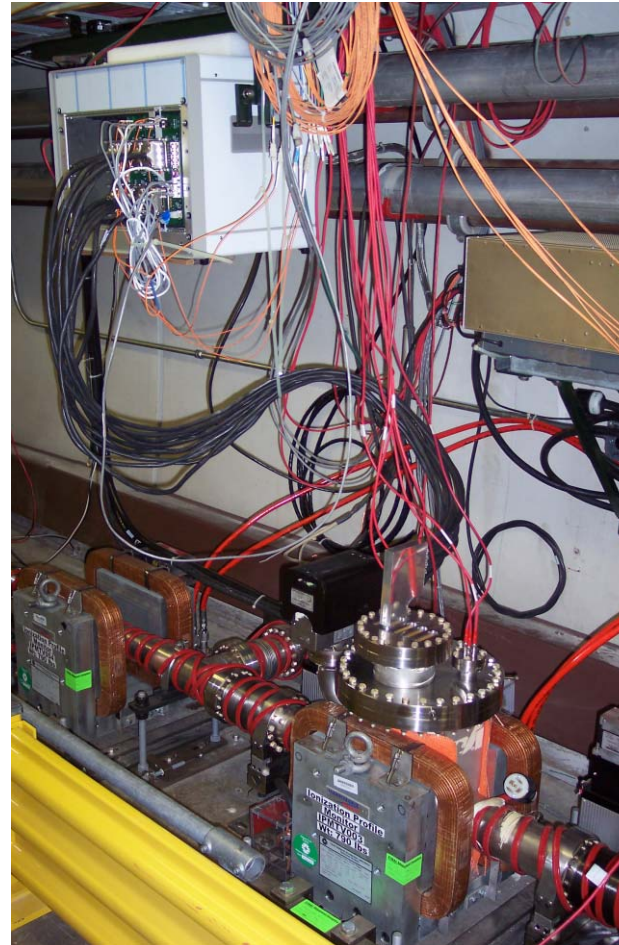

E0 straight section



E0 service building



Very first beam results

- First data taken at 980 GeV during store 4634 without magnetic field.

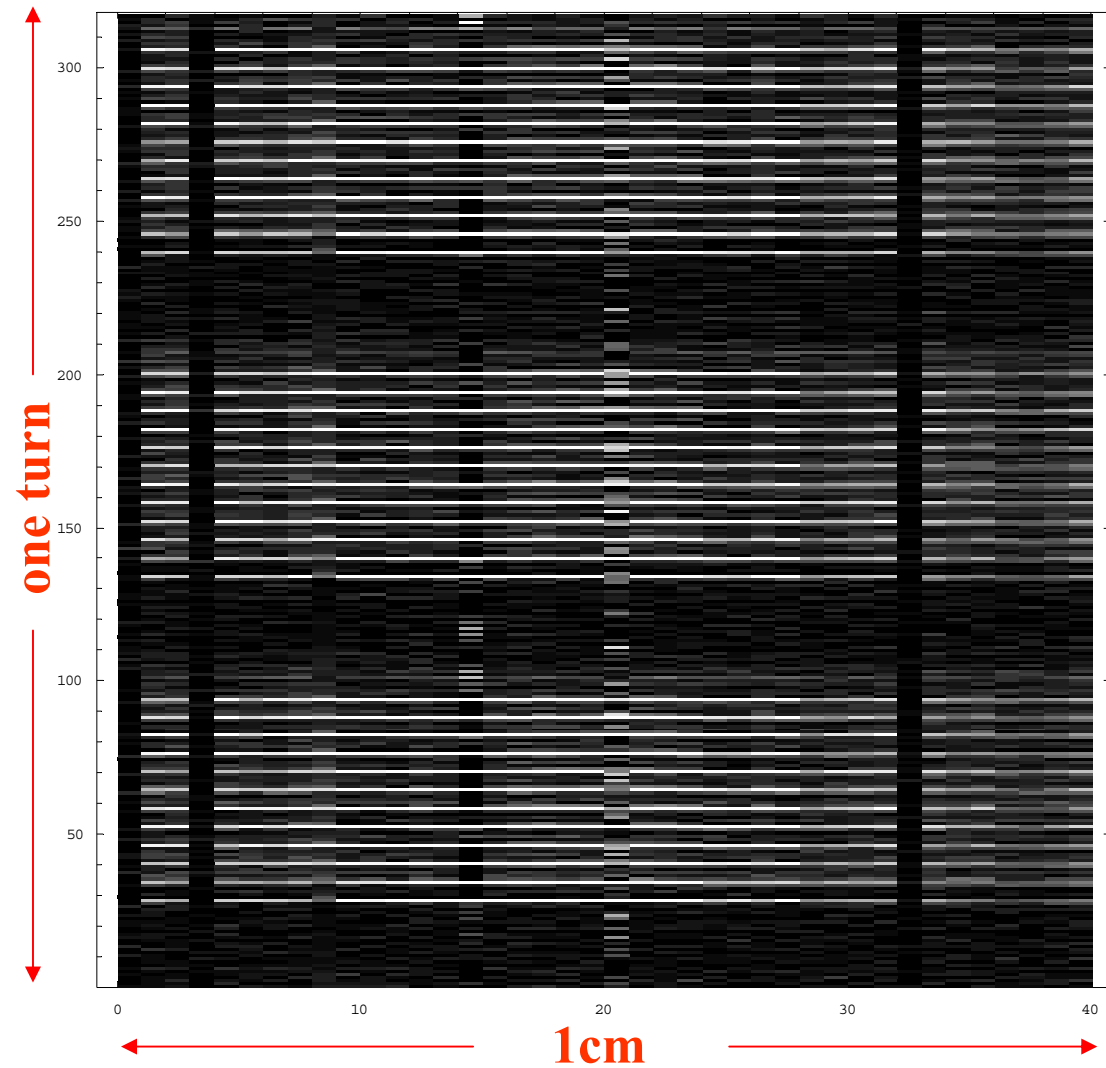

Effect of reduced field

- Sparking problems prevented running at full fields (25% B, 70% E).
- Profile widening due to large Larmor radius of electrons
- Measured resolution at 50A is 0.5 mm

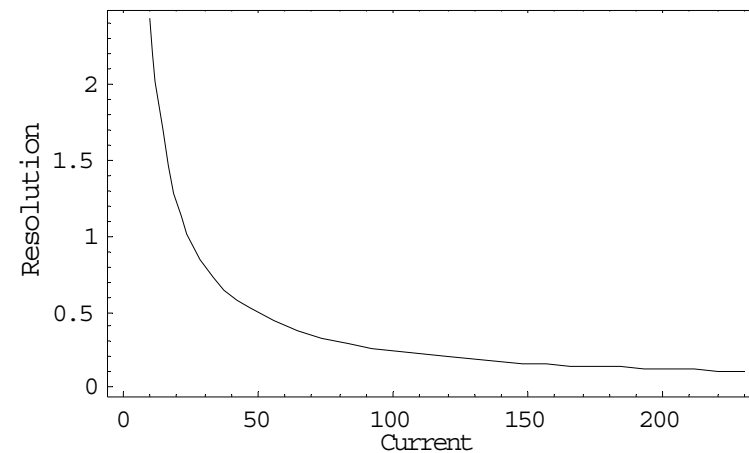
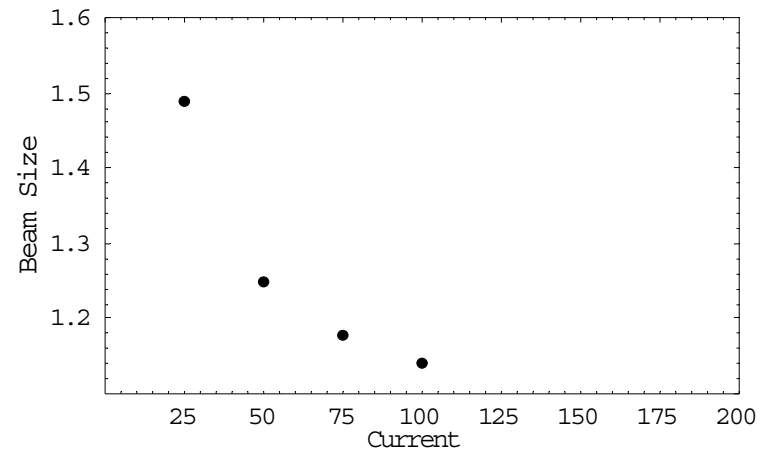

Protons during store

Store #4641
Magnet at 50A
(nominal 200A)

Single turn
profiles for
36 proton
bunches!

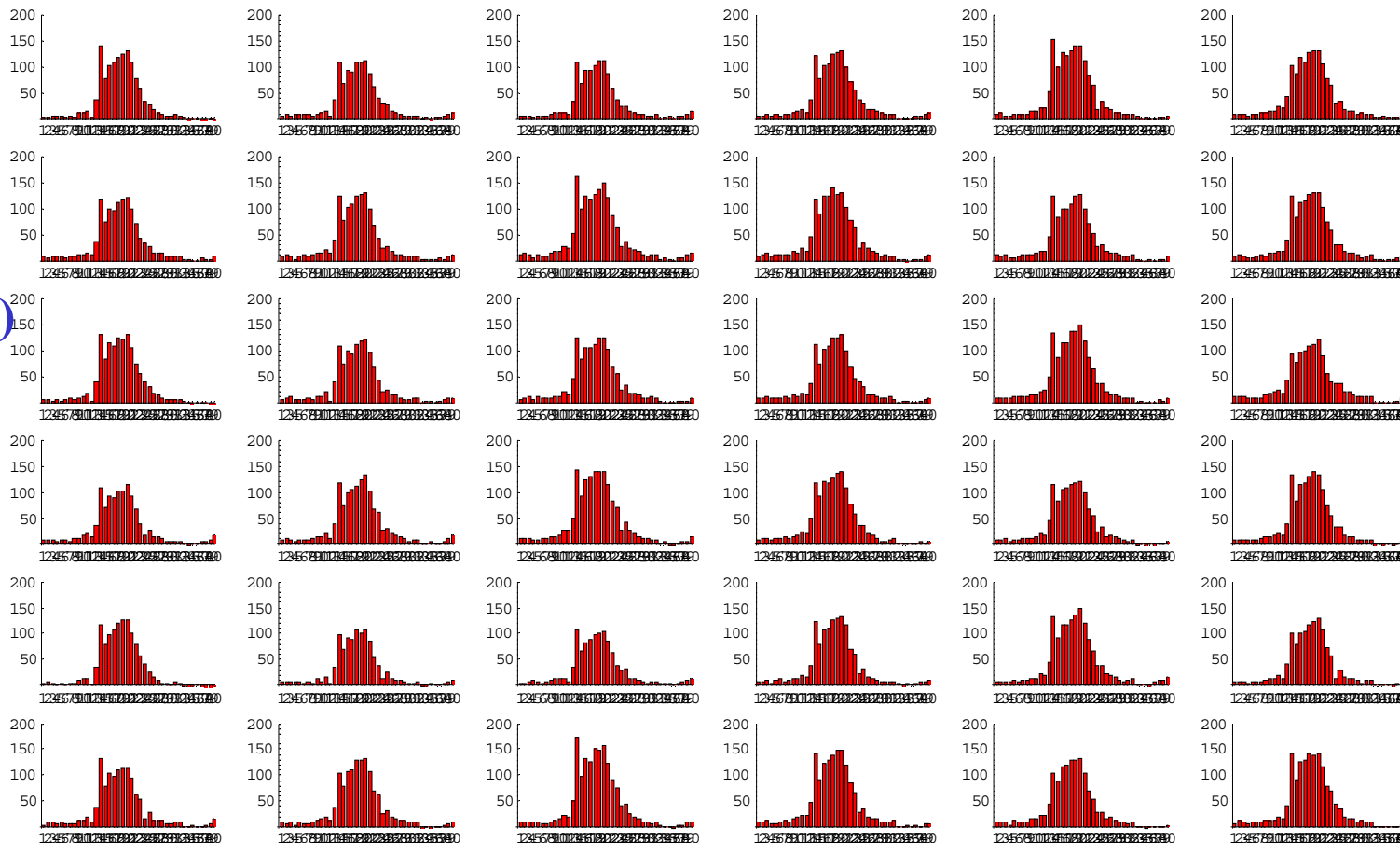

Measured profile widths at 980: 0.7-0.9 mm
consistent with flying wires taking into account the low B-field



Hint of pbars during store

Store #4641
Magnet at 50A
(nominal 200A)

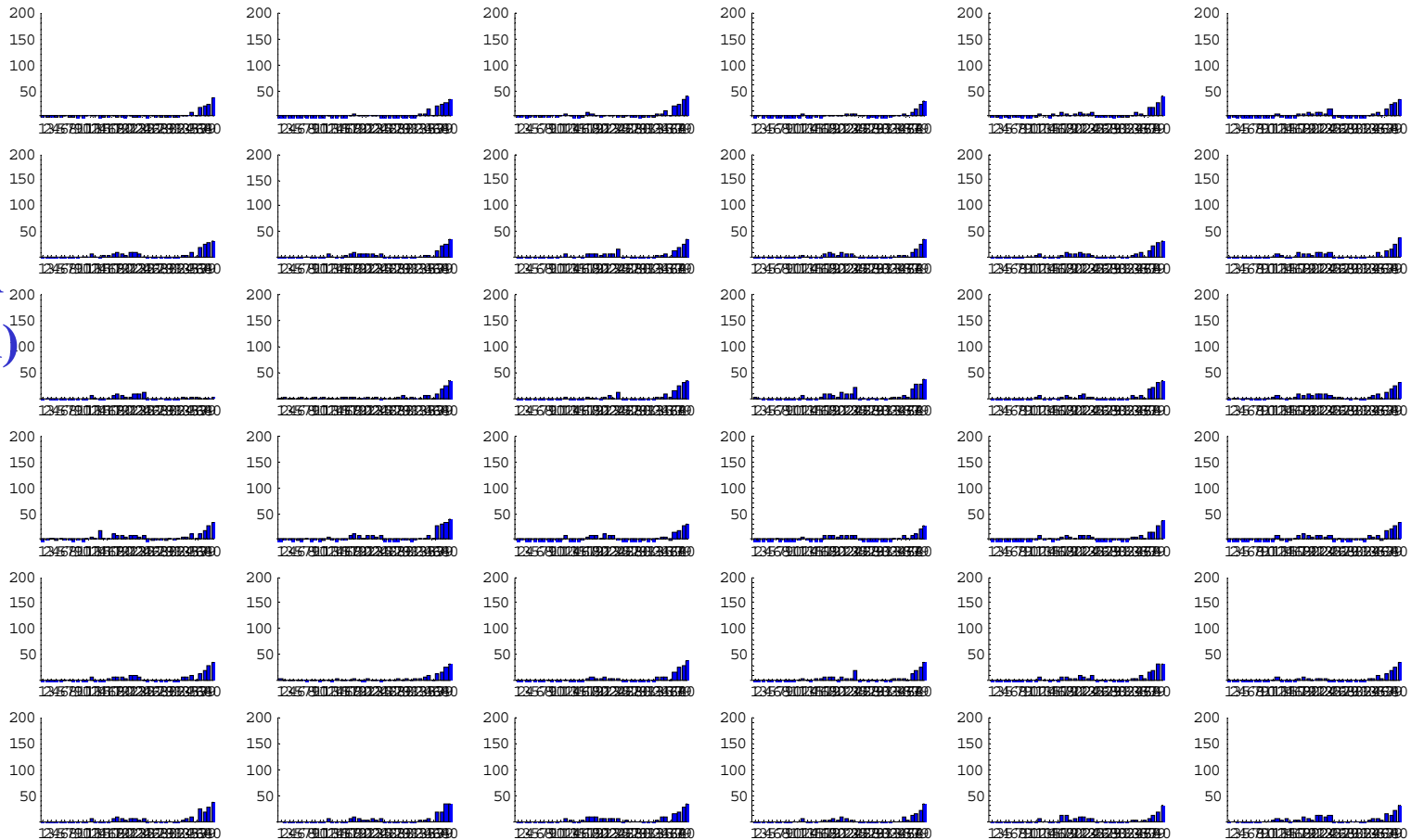

NOTE: Detector centered on proton orbit



Proton during injection

Store #4642
Magnet at 50A

Single turn
profiles for
36 bunches!

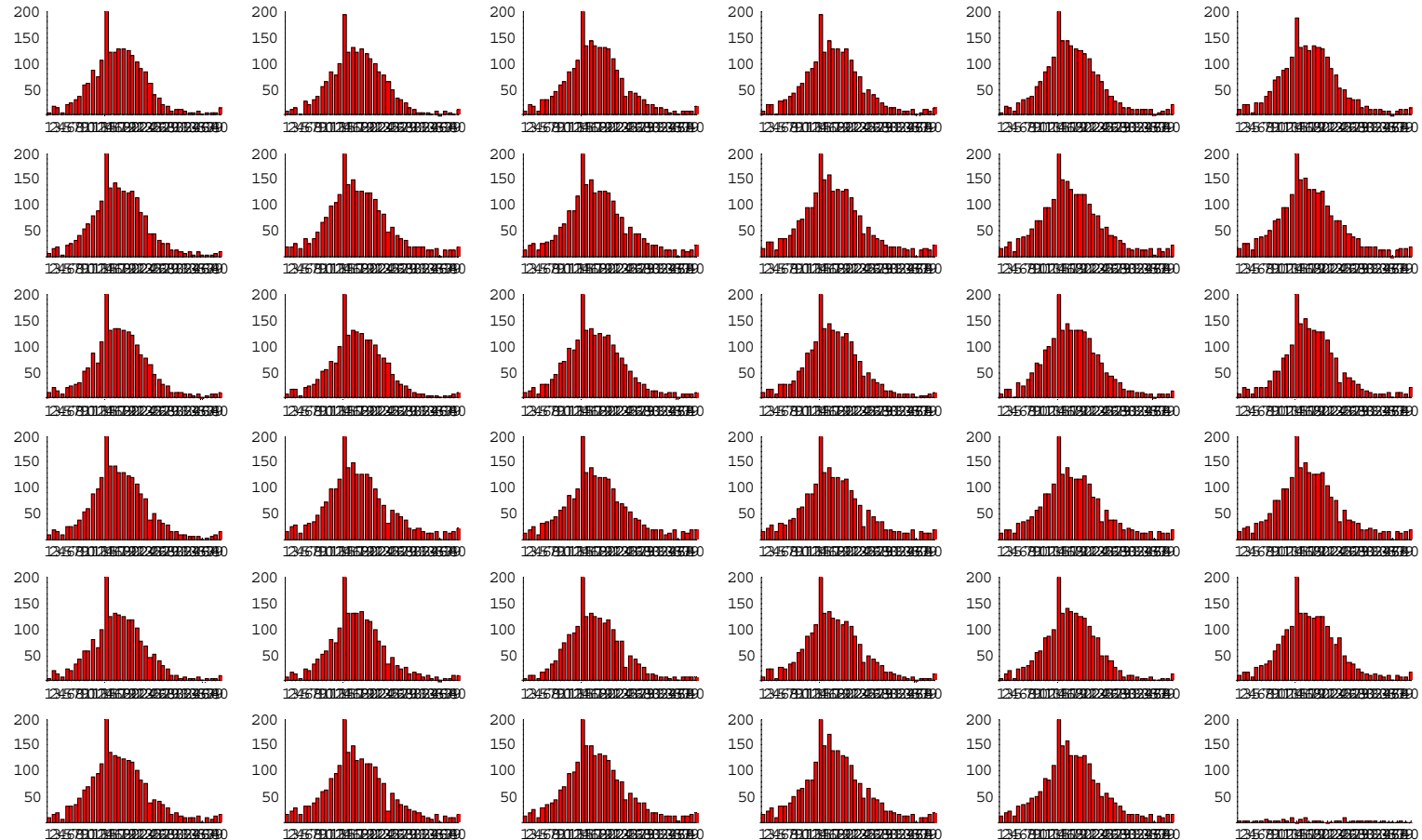

Proton profiles 16 turns before injecting P36



Protons at injection

Bunch #36 turn-by-turn

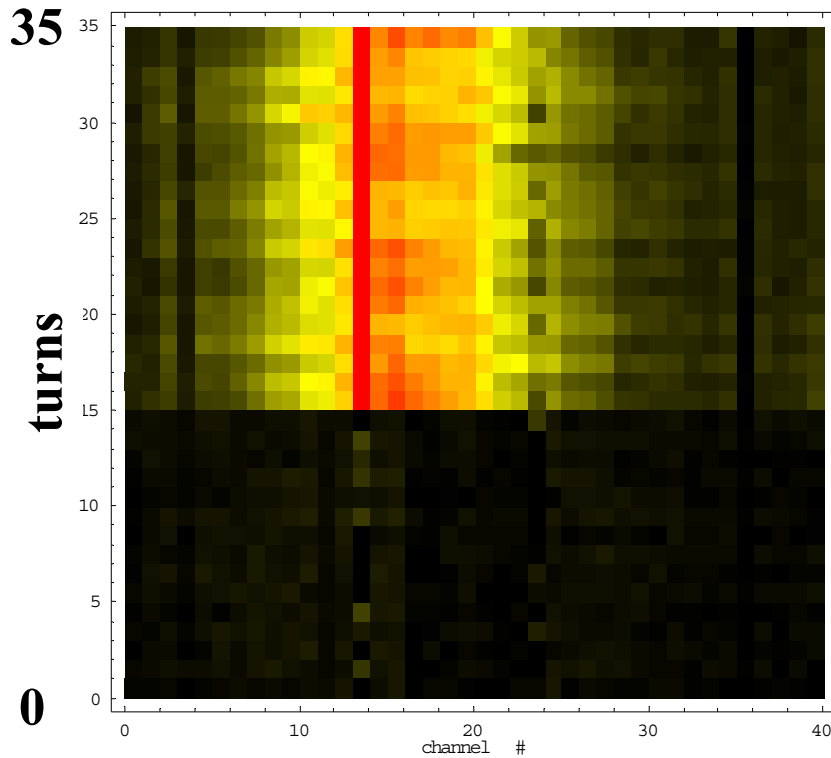

Raw profile width

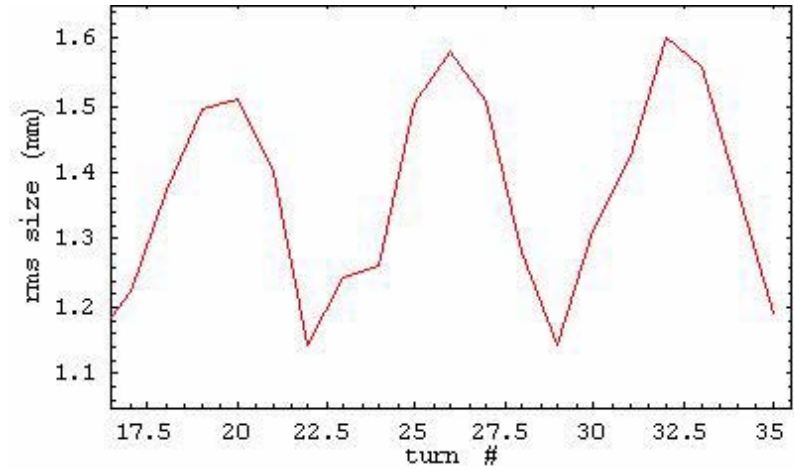

Corrected for low B-field

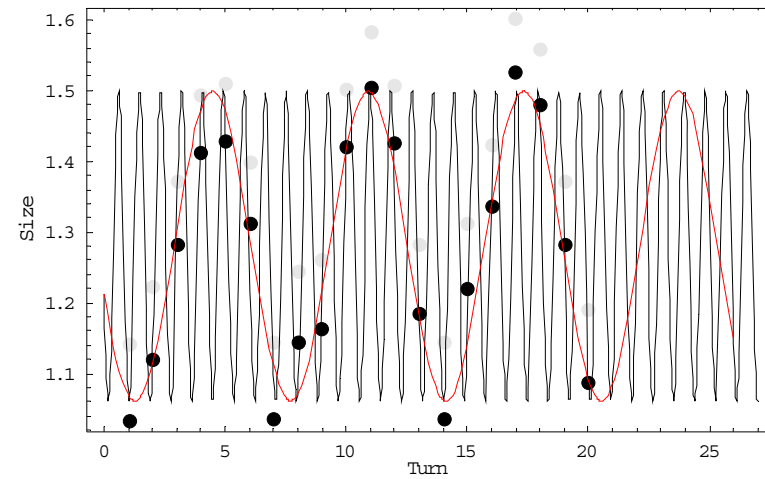

2006 shutdown work

- Vertical detector removed to fix vacuum and sparking problems. Reinstalled.
- Horizontal detector installed.
- Both systems initially instrumented with 40 out of 128 channels (1cm active width).



First profiles after shutdown

- Proton bunch #22 at 150GeV during store #4772.
- Measured beam size 1.05mm, turn-by-turn variation $\sim 50\mu\text{m}$.
- Total signal per bunch $\sim 1.7\text{pC}$.

Single bunch proton profiles

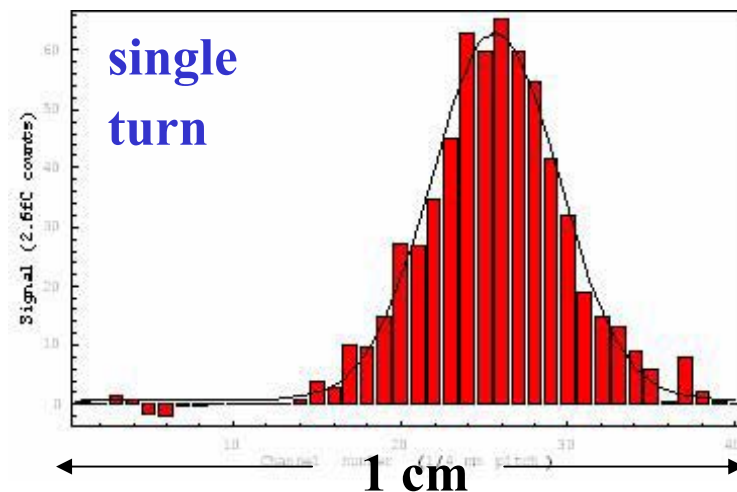
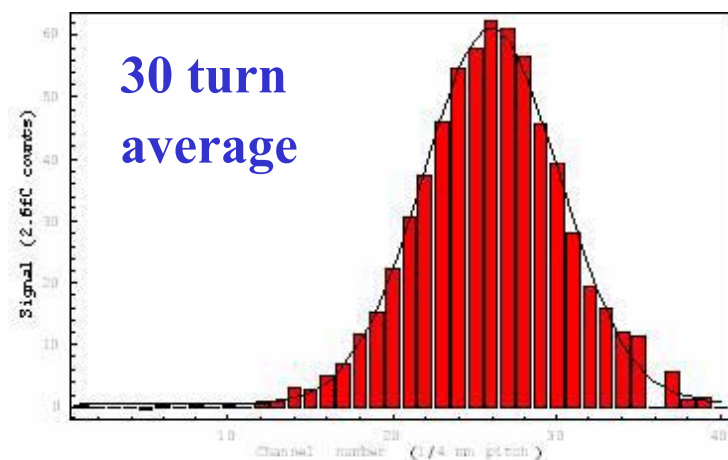

Magnet at 200A

Protons at low beta

- Proton bunch #1 at low beta during store #4758.
- Measured beam size 0.55mm, turn-by-turn variation (noise) 20 μ m.
- Total signal per bunch \sim 1.3pC.

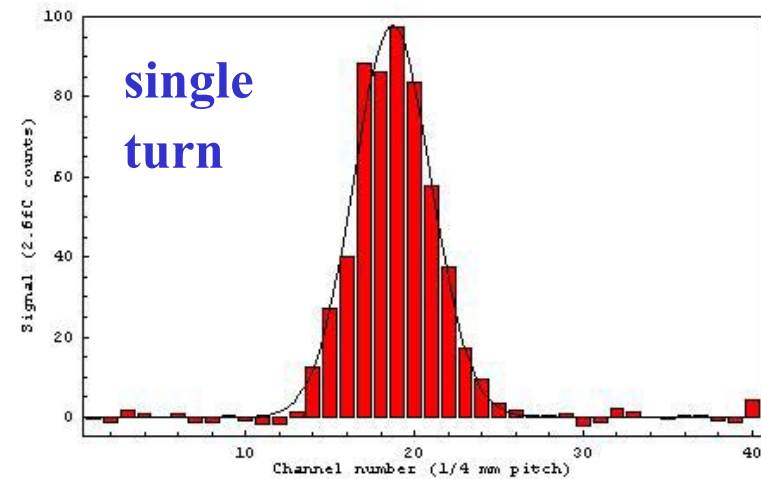
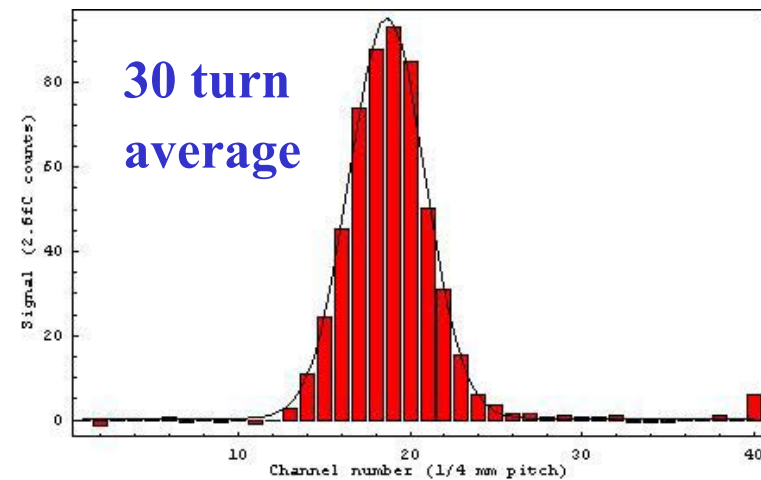

Magnet at 200A

Injection – Full B field

Proton bunch #21 turn-by-turn

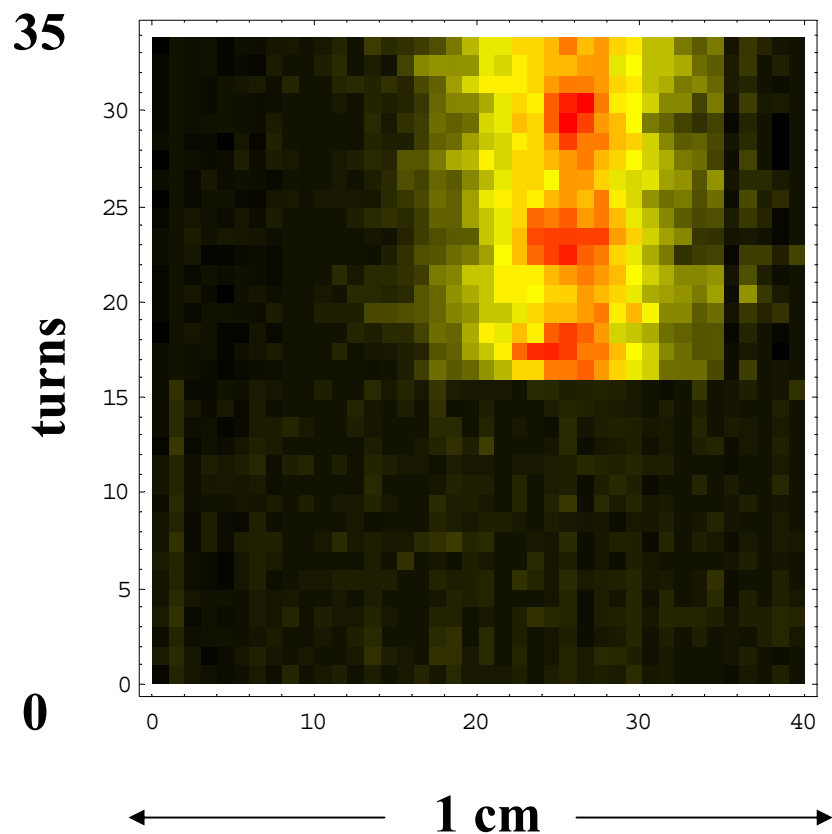

RMS profile width

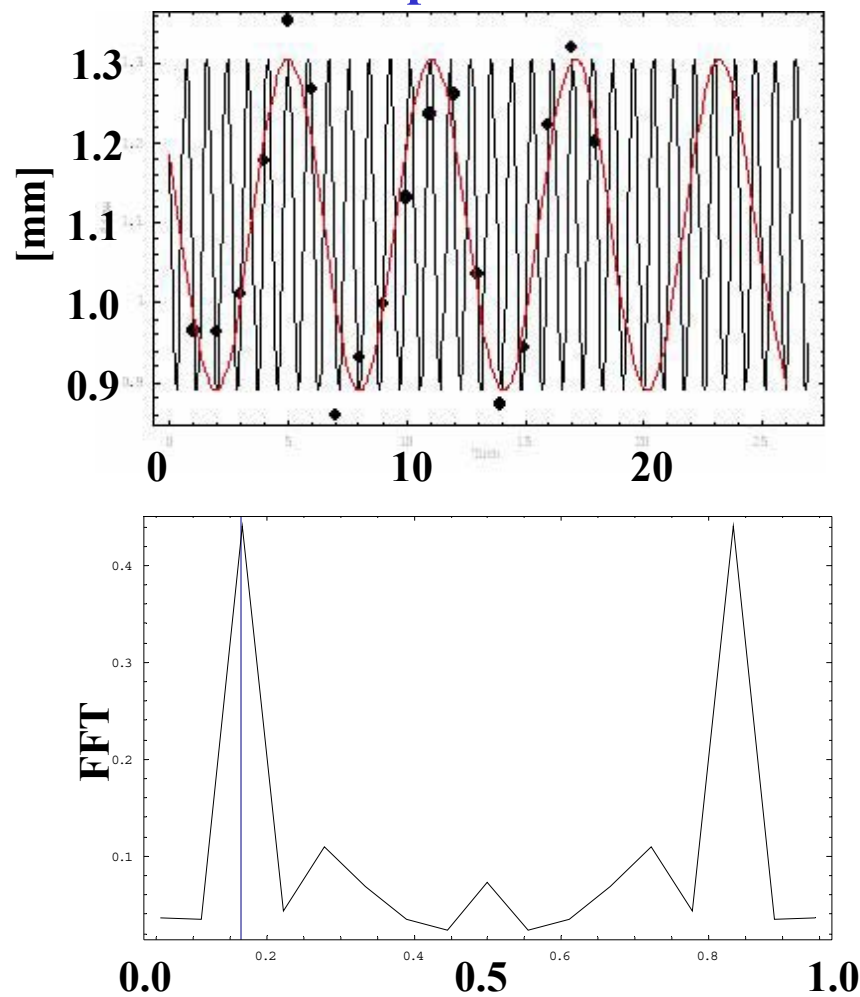

Effect of magnetic field strength

- Measured beam size and total signal as a function of magnet current.
- Resolution due to Larmor radius $\sim 0.1\text{mm}$ at 200A (2% effect for a 0.5mm beam).
- Signal increase with B-field may be due to detection efficiency (threshold is >1 primary electron per channel).

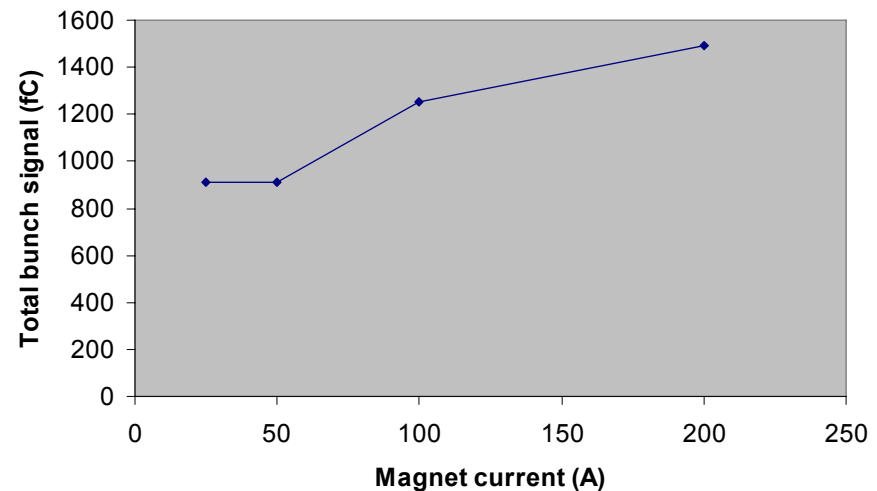
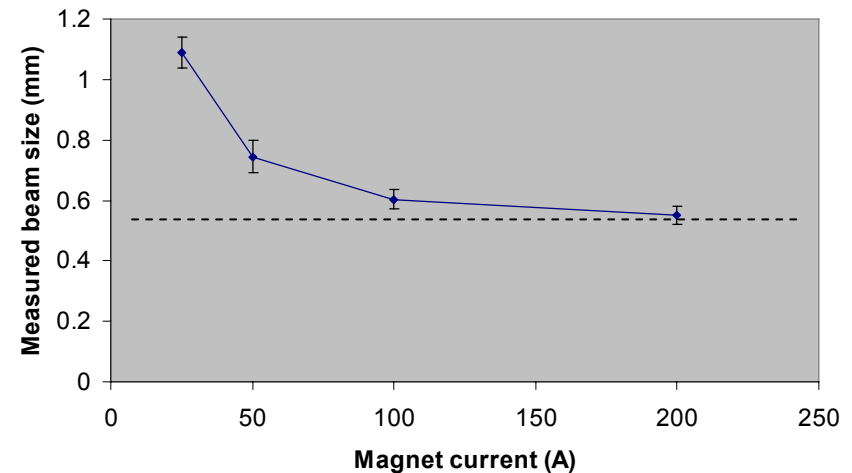

Effect of drift field strength

- Measured beam size and total signal as a function of drift field (voltage).
- Negligible effect on profile width.
- Maximum signal at ~7kV drift voltage (MCP sensitivity peaks at ~3keV for electrons)

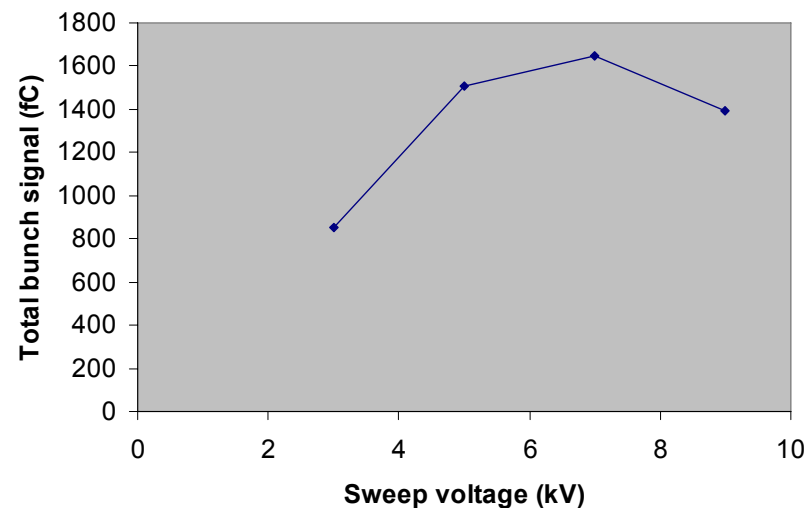
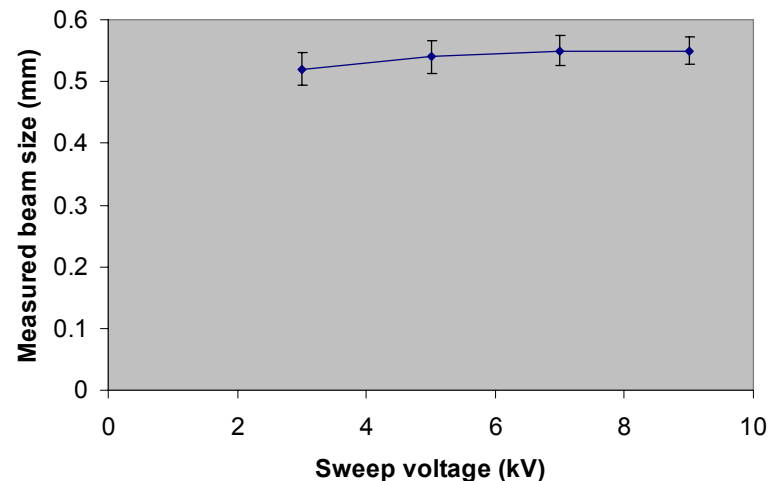

Effect of alignment

- Measured beam size and total signal as a function of tilt angle.
- No observable effect within a few mrad.

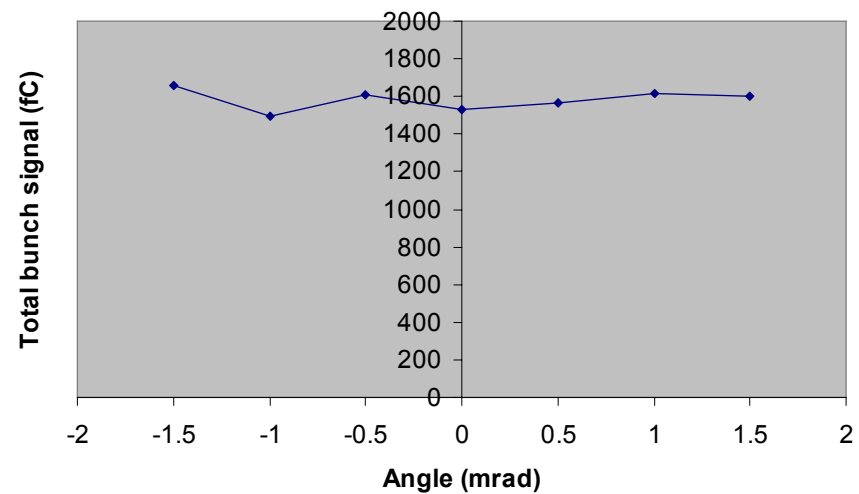
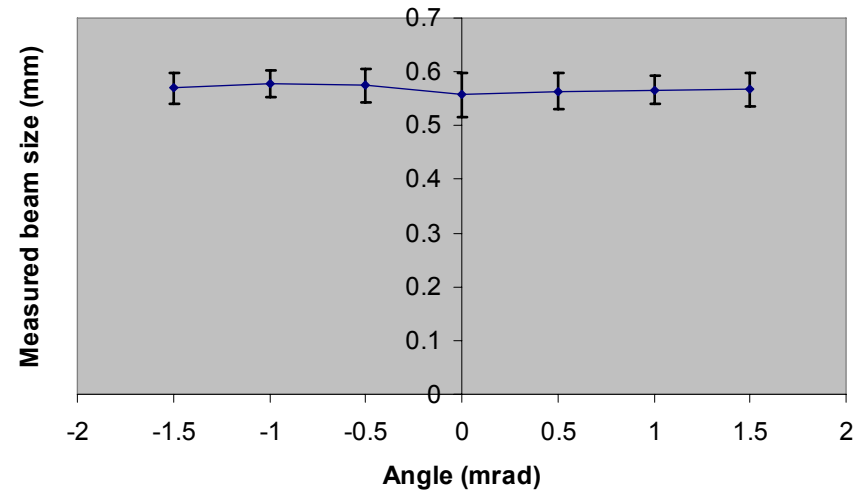

Flying wire comparison

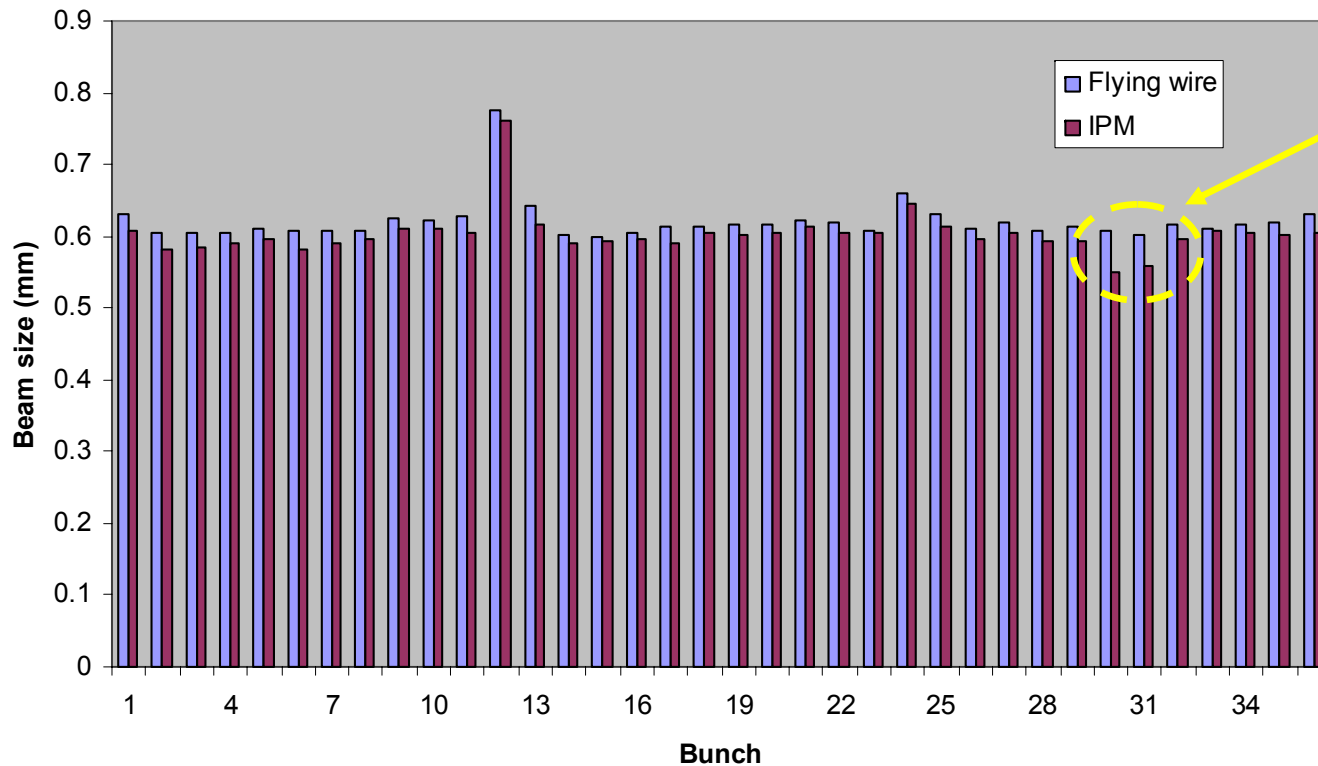

Known electronics problem (cross talk from revolution marker pulse)

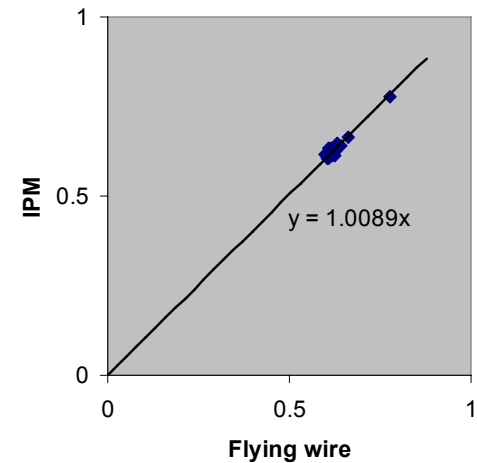

Comparison of vertical beam size from IPM and nearby Flying Wire. Tuning of abort gap cleaner timing had caused blow-up of certain bunches. From MAD lattice file, expect a 13% wider beam at Flying Wire. See ~1%.



Summary and conclusions

- The Tevatron IPMs can measure single proton bunches turn-by-turn both at injection and top energy.
- Uses custom electronics developed for Particle Physics experiments.
- Observed sensitivity of $\sim 20\mu\text{m}$ at 980GeV, 50-60 μm at 150GeV.
- Good relative agreement with Flying Wires.
- Still some work to be done (e.g. install full readout system, measure pbars, make system more user friendly, correct the observed mismatch...).

