

# FINE SPATIAL BEAM LOSS MONITORING FOR THE ISIS PROTON SYNCHROTRON

S. J. Payne, S. A. Whitehead, Rutherford Appleton Laboratory, Oxfordshire, UK

## Abstract

Beam loss detection at the ISIS synchrotron is achieved using a series of 3 and 4 metre long argon gas ionisation tubes placed around the inside track of the main ring and along the injector and extraction sections. Even with this level of diagnostics problems have occurred, for example, inside a main dipole within the accelerator ring where small concentrated areas of loss have resulted in severe damage to the RF shield. This type of loss cannot be easily resolved using the conventional argon gas system due to the length of the detectors and their distance from the vacuum vessel (around 2m). We report here the development of a compact beam loss monitoring system which has been installed inside a dipole between the vacuum vessel and the main body of the dipole. The system comprises of six 150 sq. cm. (BC408) plastic scintillators connected to photo-multiplier tubes via fibre optic bundles. Measurements taken demonstrate that the new system can easily resolve complex beam loss patterns along the dipole while remaining robust to the high radiation environment. We also report here details of our PXI based data collection and display system.

## INTRODUCTION

At the ISIS synchrotron beam loss monitoring is achieved using over 50 argon gas ionisation tubes (3 and 4 metres in length) placed horizontally around the inner circumference of the ISIS acceleration ring and along the Linac and the Extraction beamline (EPB), see [1] for detailed description. The combination of the size of these tubes and their distance from the beam line (~2 metres in the main ring) means that they do not have the sensitivity or spatial resolution to look closely at very localised beam loss. Problems have occurred at ISIS where the true magnitude and position of beam loss has gone undetected by the BLM system and this has led to the damage of an RF shield within a main ring dipole. This problem initiated the launch of a project to find a way to pin point loss more accurately. The solution involved the use of small pieces of the organic scintillator 'BC408' (Polyvinyl Toluene & Organic Fluors) which offered a fast response time ~2ps and good sensitivity to x-ray, gamma, charged particles and neutrons and yielding high light levels (blue wavelengths) [2].

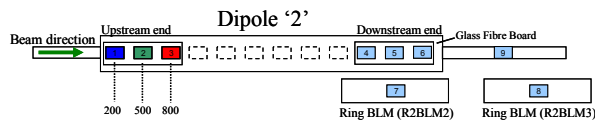

Figure 1: Scintillator (■) Positioning.

## SCINTILLATOR SYSTEM

The pieces of BC408 used measured 150mm by 100mm (3mm thick). One of the short sides was drilled with twenty 1mm holes (each 10mm deep) spaced equally along the side. Into each hole was cemented a 1mm diameter (6m long) polymer optical fibre from a bundle of 20. The scintillator and fibre assembly was then covered in a light proof sheet and taped using black plastic insulation tape to prevent any light leaks.(figure 2 - left). The fibres were held in black plastic tubing for mechanical and light leak protection.



Figure 2: Scintillator assembly and glass fibre board.

Two one metre long glass fibre boards were used to mount sets of three scintillators. (figure 2 - right). The board plus scintillator, was thin enough (~10mm) to be manoeuvred into each end of the dipole between the ceramic vacuum vessel and the coils of the dipole. Once in position the scintillator centres were located at 200mm, 500mm, and 800mm from the ends of the dipole. Two further individual scintillator assemblies were 'cable tied' to the bodies of standard argon gas BLMs. (see figure 1 schematic for layout).

Prior to assembly onto the glass fibre boards each of the nine assemblies were paired with a photomultiplier (PM) tube and calibrated in a lab using a Strontium 90 beta source and a pulse height analyser. Tube operating voltages giving equal gain for all PM tube-scintillator pairs were then obtained.

## RESULTS

### Argon Gas BLM vs. Scintillator

Of the nine scintillator systems produced two of these (number 7 and 8) were attached to standard argon gas BLMs.- denoted R2BLM2 and R2BLM3 respectively. The output of R2BLM2, over the full 10ms acceleration cycle is shown in figure 3 (bottom trace). The output of scintillator 7 is the top trace in the figure. It can be seen

that the two traces are, (when ignoring the relative amplitudes) the same, thus highlighting the equivalence of the two systems.

### Fine Spatial Resolution

Figure 4 shows the output of scintillators (SC) 1,2 and 3 placed inside the upstream end of dipole 2. From 0 to 2 ms in the ISIS accelerator cycle it can be clearly seen that the output of all scintillators are the same. This might have been expected simply because of the close proximity of the three scintillators. However from 2ms up to 8 ms the situation changes. In this region the scintillators see distinct differences in the level of beam loss which peaks at 4ms. This result shows the ability of the new scintillators to resolve beam loss patterns over relatively short distances. From 8ms until the end of the acceleration cycle the beam loss seen by all three scintillators is again the same.

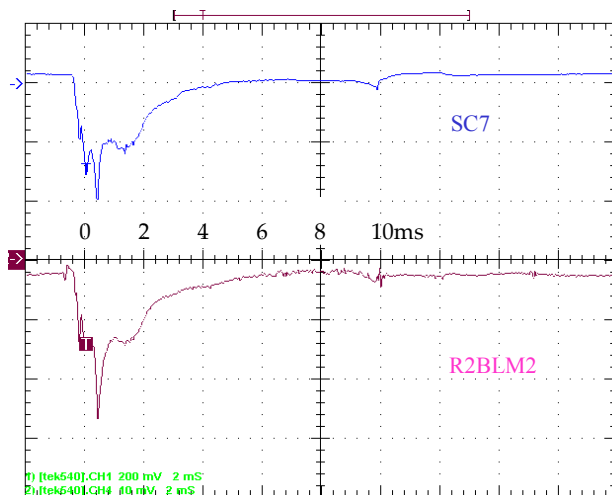

Figure 3: Argon gas BLM vs. Scintillator.

Figure 5 shows the effect of machine tuning on the loss seen at 4ms. (compare with figure 4). This reduction in loss was achieved by changes to the harmonic Q values at 3 and 4 ms. The loss seen in dipole 2 at 4ms was not visible to the standard BLM system, neither was it visible to a new scintillator system placed next to the BLM. The ability to see this extra loss in vulnerable components such as a dipole should help provide extra protection during the upgrade of ISIS to 300uA.

### Scintillator Lifetime

The scintillator system was designed to be easily renewed once its performance had declined as a result of radiation damage. However because of the scintillators location in 'hot' areas of the synchrotron access time for personnel is restricted therefore it was hoped that the lifetime of the system would be reasonably long. Figure 6 shows the output of the scintillators at 317 days showing no loss of performance. At 560 days the signals are down by a half

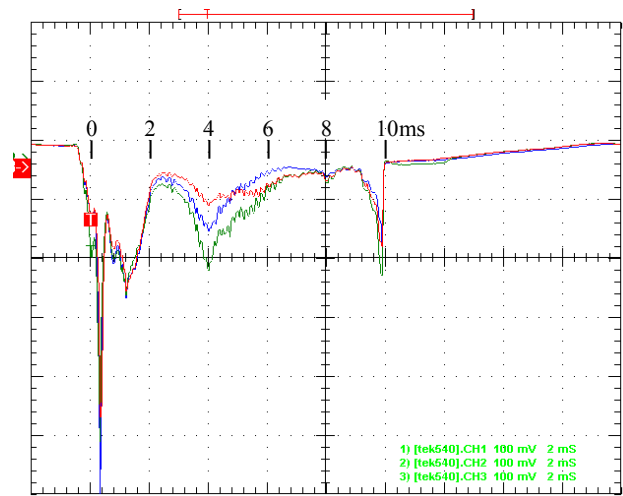

Figure 4: Scintillators SC1, SC2 & SC3 (upstream end).

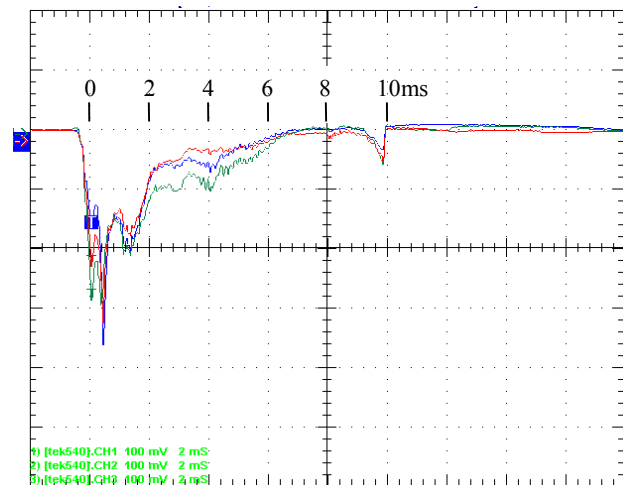

Figure 5: Loss at 4ms removed by machine tuning (figure shows SC1,SC2,SC3) – data taken on the 03/11/04.

but they can be restored by increasing the photomultiplier voltages. It is expected that the serviceable lifetime of such a system will be about 2 years depending on the amount of the radiation in the area the system is placed.

### Contribution from the Polymer Fibres

Since the optical fibre bundles are routed along the glass fibre board (shown in figure 2) any major contribution to the beam loss signal through scintillation of the fibres themselves will lead to inaccurate spatial information (cross talk errors between 'channels'). Figure 7 shows a simple set up used to measure the contribution from the optical fibres. Figure 8 shows that there was no detectable contribution from the optical fibres.

### PXI DATA ACQUISITION SYSTEM

A LabView virtual instrument has been developed to display the scintillator data (figure 9). Live readings from each scintillator are displayed on separate graphs, and a

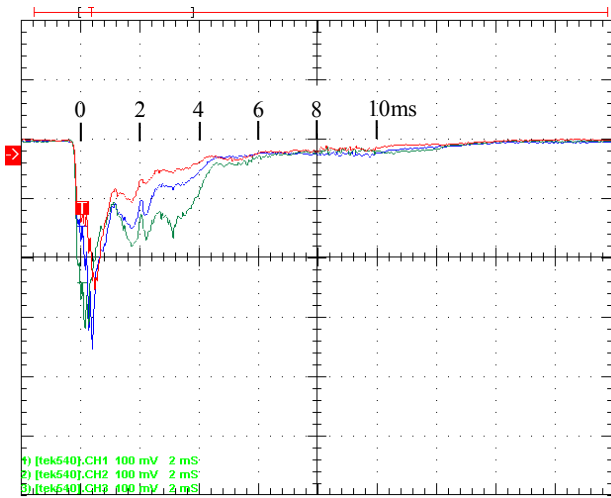

Figure 6: Scintillator SC1, SC2 and SC3 at 16-9-05.

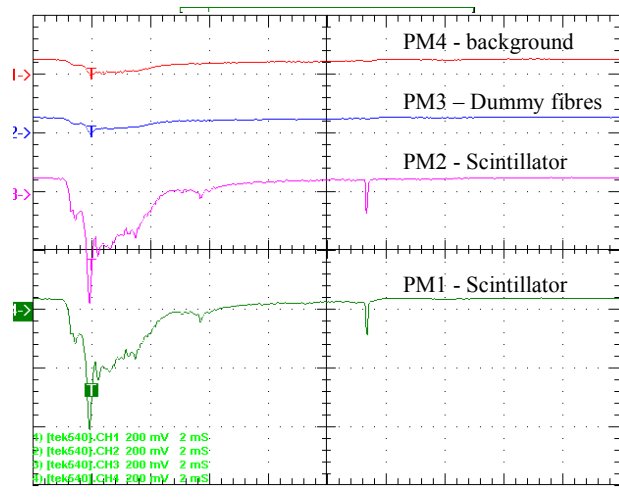

Figure 8: Showing no signal contribution from optical fibres (comparing PM3 to PM4).

set of previously stored data can be superimposed over the top (live data can be stored at any time using the store buttons on the front panel). The top graph on the right of the screen allows the user to select one graph and, by choosing a start time and a length in ms, zoom in on a specific portion of the graph. The graph below will superimpose the live data from the selected scintillators on top of each other for direct comparison. The average over a number of acceleration cycles can be displayed using the average control on the front panel. The current the beam is running at is also displayed on the front panel.

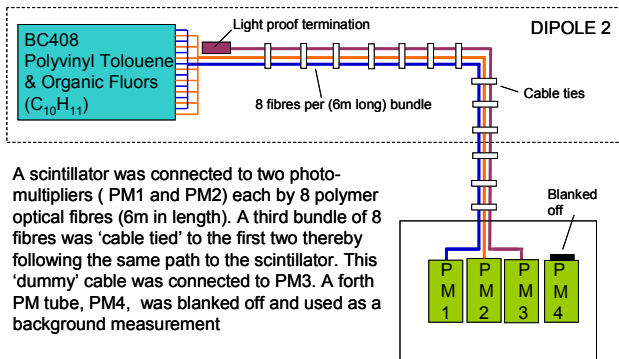

Figure 7: Measuring contribution from the optical fibres.

**SUMMARY**

We have shown that it is possible to build a compact beam loss system that can be placed inside the structure of a accelerating ring main dipole. The new scintillator based system showed up loss that was not possible to see with the ISIS argon gas BLMs. Once this new loss was found it could easily be removed using conventional machine tuning techniques. The new system has proven to be robust with a good dynamic range in terms of signal to noise ratio and time resolution. The next step is to place a further 6 scintillators into the dipole to give complete coverage along its length. (dotted outlines in figure 1)

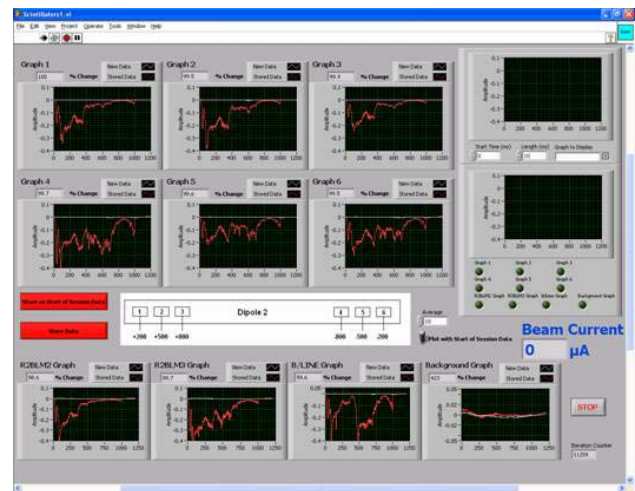

Figure 9: PXI / LabView front panel.

*Acknowledgments*

Many thanks to Nigel Rhodes, Brain Holland, Erik Schooneveld, Slobodan Marceta and the ISIS Neutron detector team for all their help in the design and construction of the scintillator system. Thanks also to Tony Kershaw and Neal Leach of the ISIS Diagnostics section for their assistance inc. PXI work. Thanks also to Derek Morrow and Roy Sulley for their invaluable help in the mechanical side to the project.

**REFERENCES**

- [1] M. A. Clarke-Gayther, Global Beam Loss Monitoring Using Long Ionisation Chambers at ISIS., Proc. EPAC.94
- [2] See BC408 Data Sheet, BICRON, Newbury, OH, USA. www.bicron.com