



Wir schaffen Wissen – heute für morgen

Paul Scherrer Institut

Jean-Yves Raguin, Markus Bopp, Alessandro Citterio, Alfred Scherer

The SwissFEL RF Gun: RF Design and Thermal Analysis

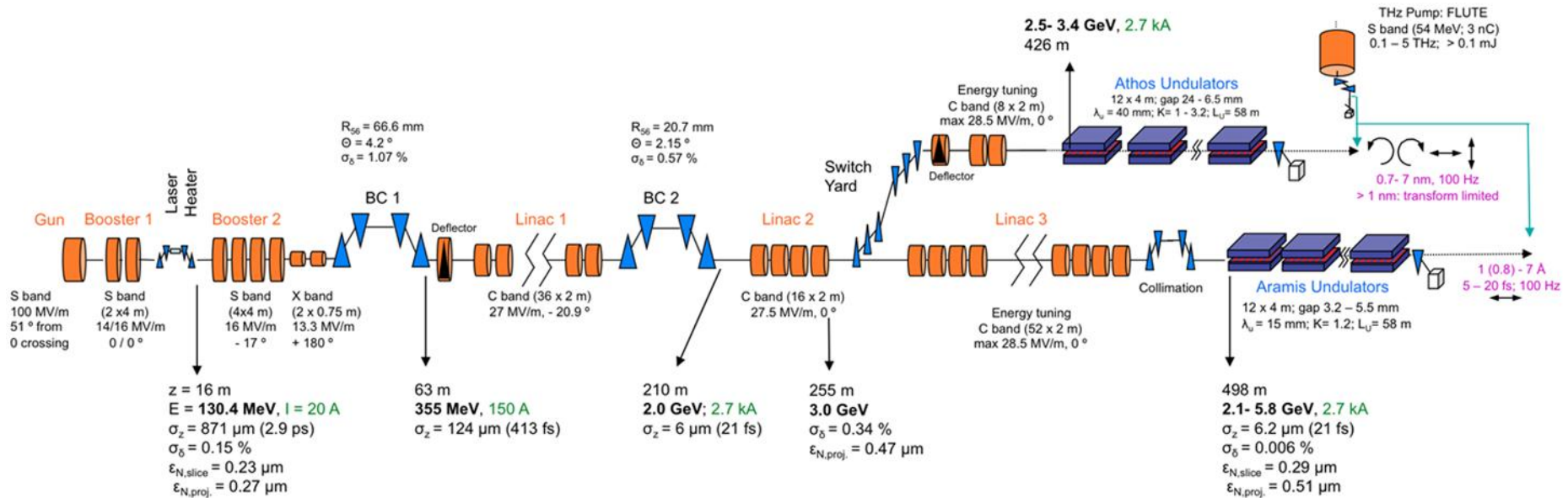

- SwissFEL targets a maximum electron beam energy of 5.8 GeV for the production of soft and hard X-rays
- Two standard electron beam operation modes
 - 200 pC charge per bunch - 0.43 mm.mrad slice emittance
 - 10 pC charge per bunch - 0.18 mm.mrad slice emittance
- Two electron bunches with 28 ns bunch spacing
- SwissFEL RF accelerating systems are designed for a repetition rate of 100 Hz and consist of:
 - 1 S-band RF gun operating at 2998.8 MHz in the π mode with peak on-axis field for 100MV/m
 - 6 S-band travelling-wave accelerating structures operating at 2998.8 MHz with a $2\pi/3$ phase advance par cell **TUPB011**
 - 112 C-band travelling-wave accelerating structures operating at 5712 MHz with a $2\pi/3$ phase advance par cell **TUPB012**

Main features

- Elliptical profile of the cell-to-cell irises to minimize surface electric field
- Half-cell and two full cells radii optimized for field flatness and to operate in the π mode
- Cell-to-cell iris radius large enough for a frequency mode separation to be higher than 15 MHz to minimize mode beating
- RF double feed in the racetrack-shaped second cell to cancel dipolar components of the fields and to minimize quadrupolar components
- Waveguide-to-cell coupling irises optimized for a coupling coefficient to be 2 and for maximum temperature rise per pulse on critical surfaces to be lower than 50° C

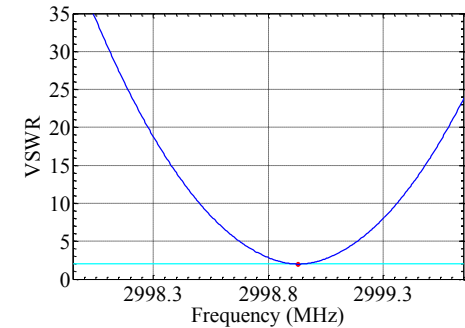
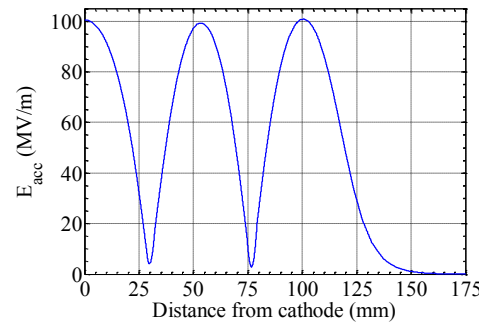
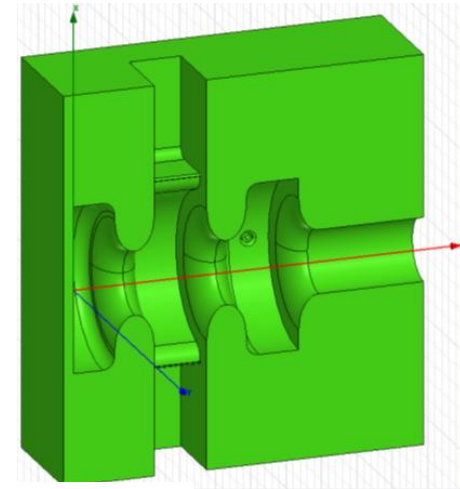

Temperature rise for a 3 μ s RF pulse and peak on-axis field of 100 MV/m

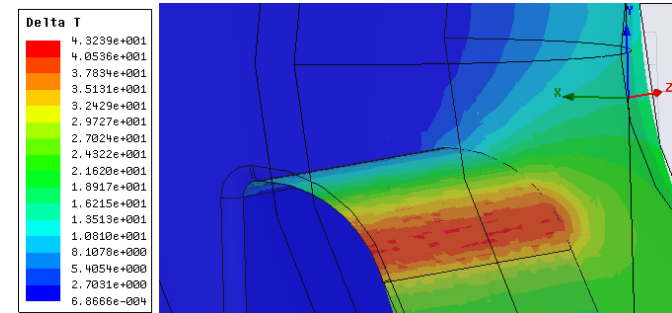
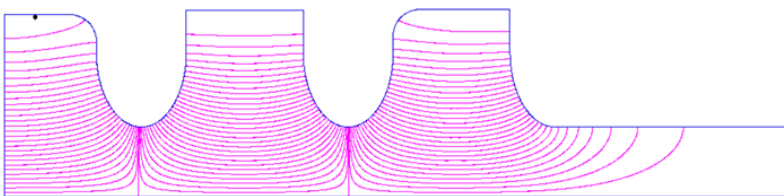

Transients and thermal stresses

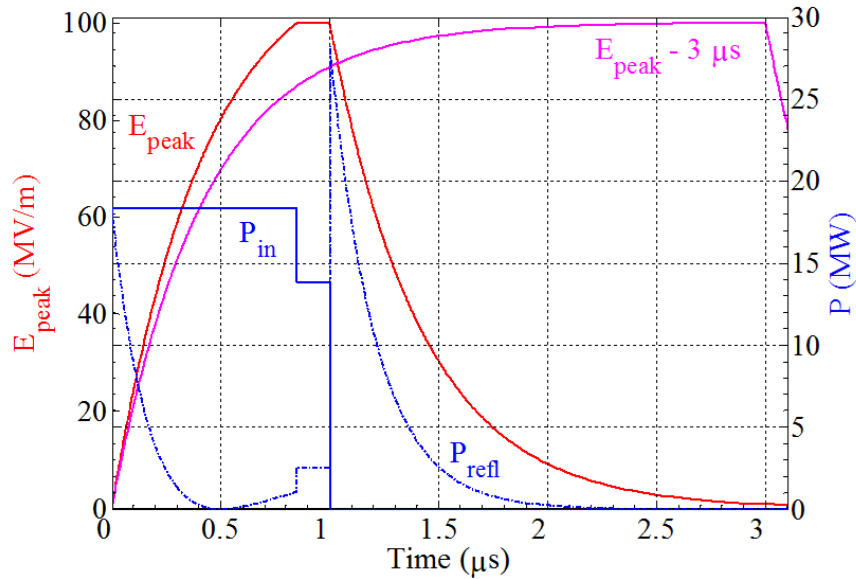

**Average dissipated power (kW)
100 Hz rep.rate**

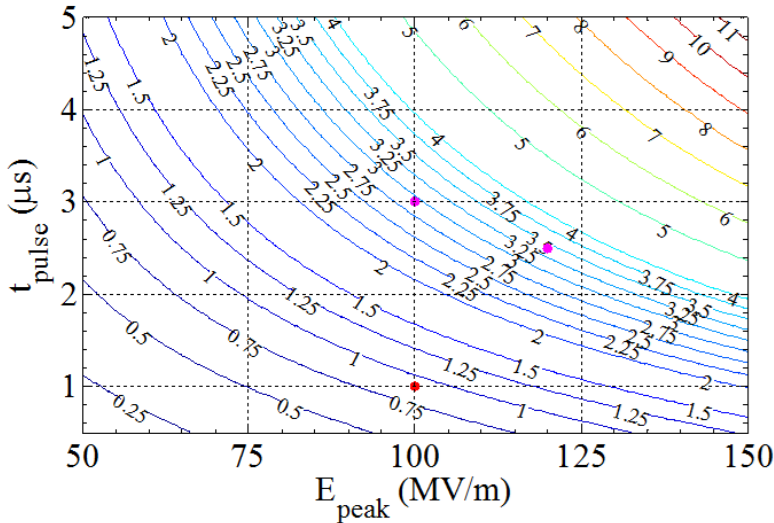

**Maximum temperature rise (°C)
on coupling irises - 100 Hz rep. rate**

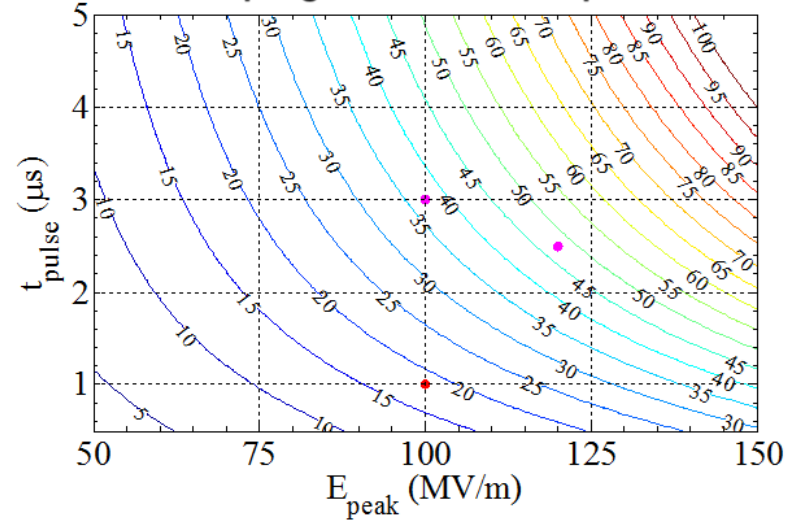

**Thermal stress (N/m²) on RF gun body for
nominal operation 0.9 kW thermal load**

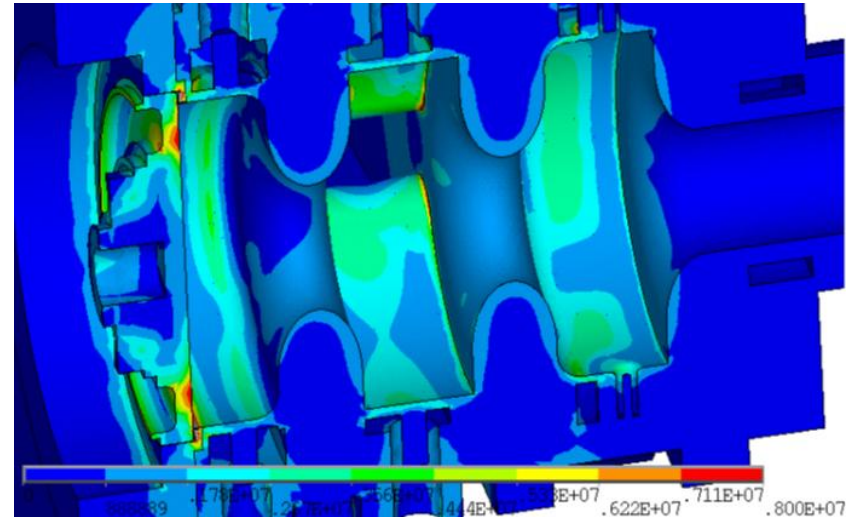

Other PSI SwissFEL-related contributions at LINAC12: TUPB009, TUPB011, TUPB012 and TUPB013

