

UPGRADE OF SAFETY INTERLOCK SYSTEM OF e+/e- LINAC FOR SuperKEKB PROJECT

A. Shirakawa[#], H. Honma, Y. Ogawa, KEK, Tsukuba, Ibaraki, Japan

Abstract

The upgrade of e+/e- Injector Linac is going on for SuperKEKB project. The Linac interlock system for personal and machine protection has been upgraded several times according to the project phase. One of the biggest changes has been made when the Linac was divided into two areas: upstream and downstream linacs, which allows us to work out the upgrade even during injection to Photon Factories at lower energies using the downstream linac. Most of the interlock system devices were duplicated to start the 'half' accelerator operation.

Another remarkable update is to adopt an RF-Gun as a new electron source. We programmed a specific strong logic for the RF-Gun operation. These upgrades will be reported with the introduction of the whole interlock system.

OUTLINE OF INTERLOCK SYSTEM

KEK e+/e- Linac is the injector for PF-Ring, PF-AR and KEKB (SuperKEKB) accelerators (see Fig. 1). After KEKB experiment stopped in June 2010, the Linac has been upgraded gradually for SuperKEKB. Damping Ring (DR) for beam emittance reduction is under construction in the middle of the Linac [1, 2].

In our system personal and machine protection are combined. It covers whole the 600m-long accelerator. Interlock system for DR will be separated and handled by other system.

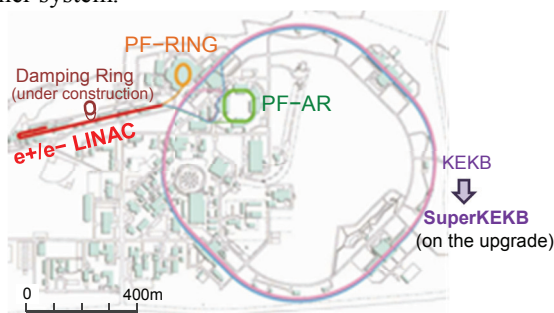

Figure 1: KEK e+/e- Linac and related accelerators.

System Layout

Figure 2 shows a rough image of the interlock system structure. We have Yokogawa PLC as a main CPU for interlock logic program. All the signals from Linac equipment are electrically connected to PLC via metal cables. There is another PLC as a gateway. It is connected with main PLC via specified link and transfers information to Linac control network. Status of the system is shown on a Windows PC at operator's console. Even in case of LAN trouble, the interlock system will

keep normal operation.

The system communicates with Ring accelerators and receives a kind of 'permission for operation' from them. Table 1 shows destinations and number of Linac interlock signals. Numbers in the table are those handled at PLC and some of signals spread out at intermediate controllers.

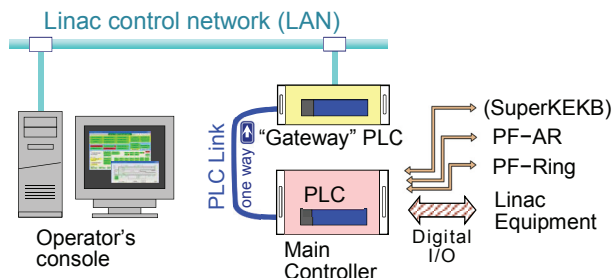

Figure 2: A rough view of Linac interlock system layout.

Table 1: Destination and Number of Linac Interlock Signals at the Central CPU

Destination of Signal	# In/Out	Personal Protection	Machine Protection
Doors	50 / 0	✓	
Emergency switches	10 / 0	✓	
Beam trigger system	0 / 10	✓	
High power RF PS	70 / 21	✓	
e- Guns	7 / 5	✓	✓
Operation console	20 / 32	✓	✓
Charge monitors	9 / 0	✓	✓
Vacuum gate valves	35 / 0		✓
Vacuum gauges	13 / 0		✓
PF-AR	5 / 6	✓	
PF-Ring	4 / 5	✓	
SuperKEKB + DR	TBD	✓	

Conditions for Linac Operation

Since radiation level is high in the accelerator area during its operation, basic concept for personal safety is to keep out from the area. In our system we have to carry what we call a "personal key" (see image in Fig. 3) when we enter the area for machine maintenance. All the personal keys must be returned to resume the operation. Figure 3 shows all the conditions for Linac operation.

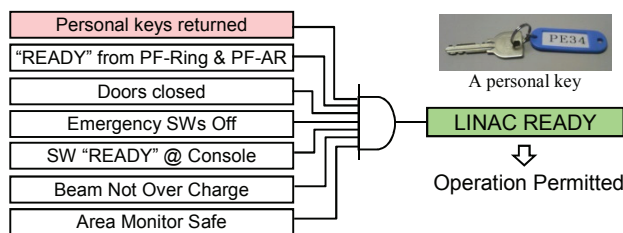

Figure 3: Conditions for Linac operation and an image of "Personal key" for room access control.

[#]akihiro.shirakawa@kek.jp

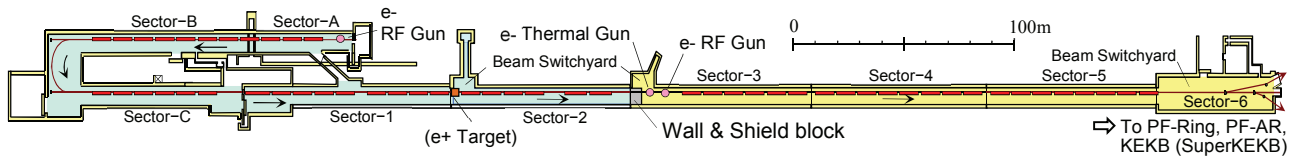

Figure 4: An image of the division of e+/e- Linac. It is separated at the beginning of Sector-3 and ‘down half operation’ is available.

DIVISION OF LINAC AND NEW OPERATION MODE

For around 30 years since its foundation, the Linac had one long straight room for accelerator. After KEKB data taking was stopped, we divided the room into two areas so that we could proceed with upgrade and inject beam to downstream rings simultaneously. In advance of the division, the temporary e- gun was moved downward to the place where e- beam energy of 3GeV at maximum can be obtained at the end of Linac. In parallel, RF guns were installed at the beginnings of ‘upstream’ (Sector-A) and ‘downstream’ (Sector-3) respectively and their tests have been started [3]. Figure 4 shows an image of the division. The partition is built between Sector-2 and -3.

The division is one of the steps toward SuperKEKB. It will be entirely cleared before SuperKEKB is started.

Assembly of a Partition

One of the most difficult steps for upgrade was assembling a partition to separate areas. Concrete shield blocks with a thickness of 60cm were piled up alternately in two rows, with intervals of 113cm for a passageway. An iron wall with an interlocked door is attached to the first row (Figs. 5, 6a). The radiation level in front of the blocks during operation is low enough against KEK rule for admitted area (< 20μSv/h) [4].

The assembly was done in 2010 and later the wall and blocks have been moved by 10m downward (Fig. 6b) in 2012. The reasons for the first place were:

- there occupied rather wide area as a beam switchyard
- could have enough distance between shields and beam bunching section (i.e., lower radiation level in front of the wall)

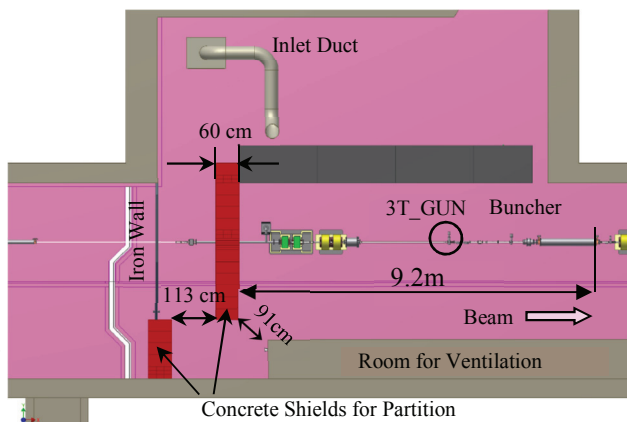

Figure 5: A layout of the partition.

And after two years of operation, we had to move the wall to vacate the switchyard to start construction of beam lines to Damping Ring. As space is more restricted at new place, a part of ventilation room had to be removed for about 10m long. The specification of shields and relative position of block rows are same as before.

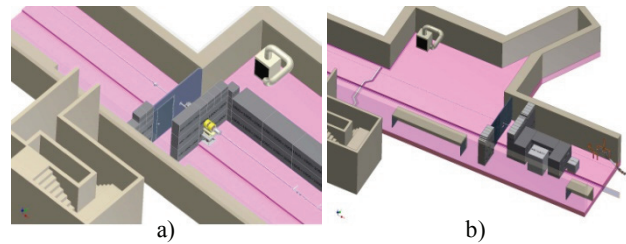

Figure 6: Partition at original position (a) and after movement (b).

Operation Modes after the Division of Linac

Now we have a thermal e- gun at Sector-3, and RF guns at Sector-A and -3. After the division of Linac, we can carry on development or maintenance work in upstream side regardless of operation status of Sector-3 guns. Beam injection to PF-Ring and PF-AR is from the thermal gun. The condition of ‘Ready’ shown in Fig. 3 has been newly set for ‘Sector 3-6’ in addition to conventional ‘All Linac Ready’. To run RF gun in Sector-A, ‘ALL Linac’ must be ready because there is no beam dump at the end of Sector-2 and beam will go through to the end.

Duplication of Personal Key Management System

A new set of personal key management system is assembled to form ‘Sector 3-6 Ready’ as described above. Figure 7 shows an image of the system layout. As some of the components are from other system and adjusted to this system, we could save cost and time.

A specified PLC is in the key box controller. It receives information on Linac operation status from main PLC and manages key I/O. We use magnetic ID card to pull out the keys. A PC as an indicator is connected via an independent LAN.

There are an electric lock on the partition door and a door controller next to it. The ‘personal key’ is used to unlock the door. Those specifications are identical with the conventional system.

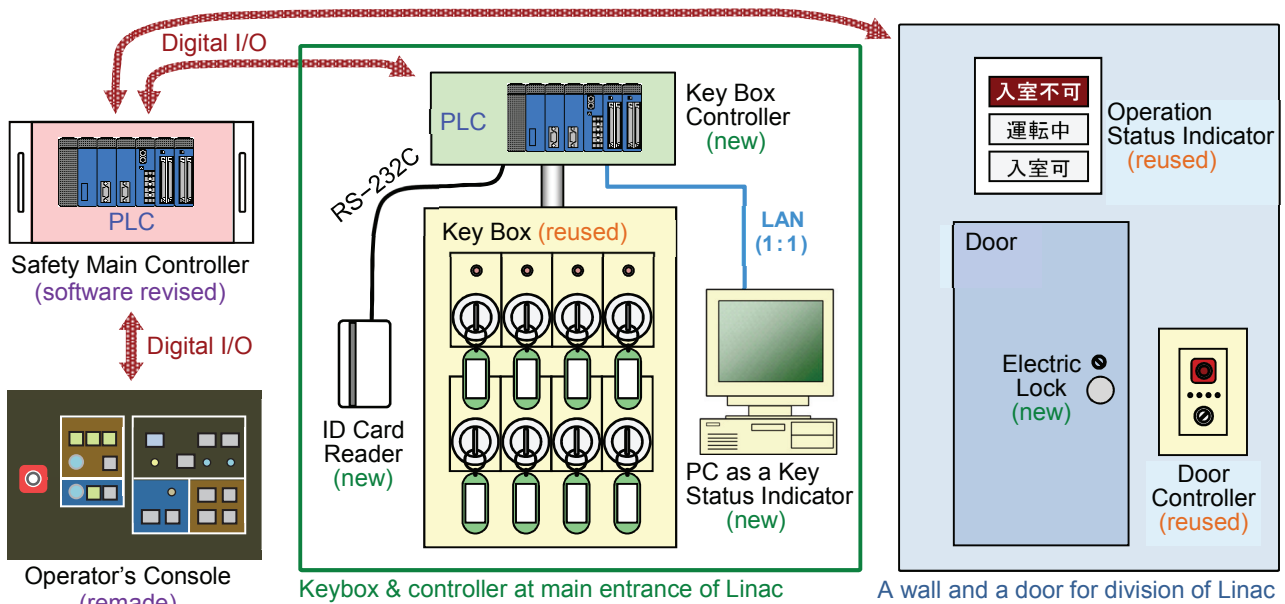

Figure 7: Layout of the personal key management system newly set for down half part of Linac. Some of the parts are secondhand articles.

INTERLOCK FOR RF GUN OPERATION

Figure 8 shows a rough view of composition around RF gun. Since it is new to our system, we referred to conventional safety interlock for thermal gun when we programmed the logic. In the thermal gun, we regard “High voltage on to gun electrodes” as “Beam on”. In comparison to it, “RF source power on” should be the same for RF guns. Therefore, the condition “Linac Ready” (shown in Fig. 3) is required to permit “High Power RF” (Fig. 9).

In addition to terms above, we placed “Laser shutter” on laser beam path and gate valve on the beamline (Fig.8). The gate valve is to guarantee safety during machine maintenance. In order to supply laser to the gun, both “Linac Ready” and “gate valve open” should hold. The logic performs a kind of fail-safe.

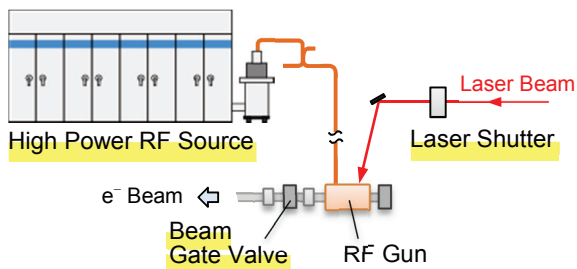

Figure 8: A rough view of composition around RF gun. Underlined components are related to safety interlock.

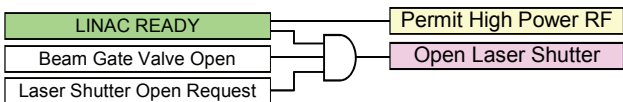

Figure 9: Conditions for beam operation from RF gun.

SUMMARY

KEK e+/e- Linac presently operates as the injector to PF-Ring, PF-AR and on the upgrade toward SuperKEKB. One of the biggest changes in the safety interlock system upgrade was the division of Linac into two areas. A partition with iron wall and shield blocks has been assembled and an access control system for down half part of Linac is newly composed.

After the division, development at upstream side and beam injection to PF-Ring from downstream Linac are available simultaneously.

RF guns have been installed as a new electron source at two sections. We programmed a specific strong logic for the RF gun operation.

ACKNOWLEDGMENT

Authors would like to acknowledge M. Yoshida and T. Natsui for their collaboration to establish safety interlock architecture for RF gun operation.

REFERENCES

- [1] T. Kamitani et al., “Injector Linac Upgrade for SuperKEKB,” LINAC2010, Tsukuba, September 2010, MOP011, p. 70 (2010).
- [2] K. Furukawa et al., “High-intensity and Low-emittance Upgrade of 7-GeV Injector Linac towards SuperKEKB”, IPAC2013, Shanghai, 2013, TUPME010, these proceedings.
- [3] M. Yoshida et al., “SuperKEKB Injector Upgrade for High Charge and Low Emittance Electron Beam,” IPAC2012, New Orleans, May 2012, TUPPD035, p. 1482 (2012).
- [4] H. Honma, “Present Status of the KEK Electron /Positron Injector Linac (in Japanese),” 8th Annual Meeting of Particle Accelerator Society of Japan, Tsukuba, August 2011, TUPS033, p. 926 (2011).