

INSTRUMENTATION FOR THE PROPOSED LOW ENERGY RHIC ELECTRON COOLING PROJECT*

D. Gassner[#], A. Fedotov, D. Kayran, R. Michnoff, T. Miller, M. Minty, I. Pinayev, M. Wilinski, V. Litvinenko
Collider-Accelerator Department, BNL, Upton, NY 11973, USA

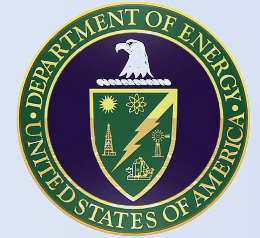

BROOKHAVEN NATIONAL LABORATORY

*Work supported by the auspices of the US Department of Energy
[#]gassner@bnl.gov



Abstract

There is a strong interest in running RHIC at low ion beam energies of 2.5-20GeV/nucleon; this is much lower than the typical operations with 100GeV/nucleon. The primary motivation for this effort is to explore the existence and location of the critical point on the QCD phase diagram. Electron cooling can increase the average integrated luminosity and increase the length of the stored lifetime. A cooling system is being designed that will provide a 10 – 50mA electron beam with adequate quality and an energy range of 0.9 – 5MeV. The cooling facility [1] planned in RHIC will include a 84.45MHz SRF gun and booster cavity, and a beam transport to the Blue ring to allow electron-ion co-propagation for ~ 12m, then a 180 degree U-turn electron transport so the same electron beam can similarly cool the Yellow ion beam, then to a dump. The instrumentation systems that will be described include current transformers, BPMs, profile monitors, a pepper pot emittance station and loss monitors.

Introduction

The Low Energy RHIC electron Cooling (LEReC) project is scheduled to begin commissioning components in 2017, with operations planned for 2018-19. This will be the first bunched beam electron cooler and the first electron cooler in a collider. The goal is to achieve an efficient cooling system for Au+Au collision beams at 7.7, 11.5 and 20GeV/u in the center of mass corresponding to electron energies of 1.6, 2.7 and 5.0 MeV. An effective cooling process would allow us to cool the beams beyond their natural emittances and also to either overcome or to significantly mitigate limitations caused by intrabeam scattering and other effects. It also would provide for longer and more efficient stores, which would result in significantly higher integrated luminosity. With electron cooling it seems feasible to have about a factor of 3-6 improvement in average luminosity depending on the energy which would enable detailed studies of signatures of the Critical Point.

The LEReC project is presently in the design stage. Cooling of ion and hadron beams at low energy is also of critical importance for the productivity of present and future Nuclear Physics Colliders, such as RHIC, eRHIC and ELIC.

The electron beam diagnostics will provide the necessary measurements to commission the 84.45 MHz SRF gun, with a maximum energy of 2.5 MeV beam, that is coupled to the 84.45 MHz SRF 2.5MV booster cavity in the same cryostat to provide the 5 MeV beam into the straight transport line to a warm 500 MHz (6th harmonic of the SRF frequency) copper cavity for energy spread correction. The laser will provide 700ps FWHM pulses with <150ps rise and fall times at up to 100MHz rates.

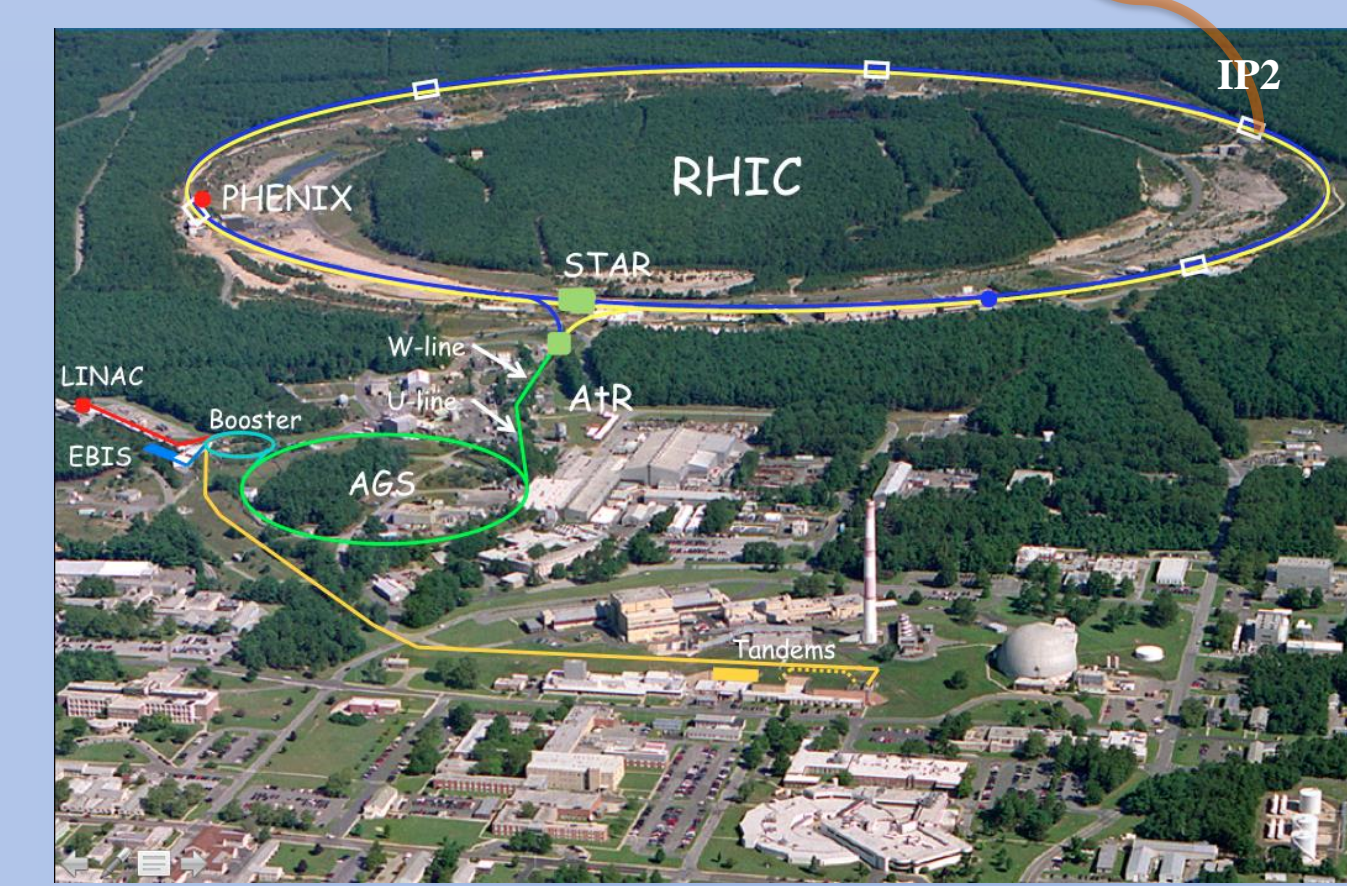
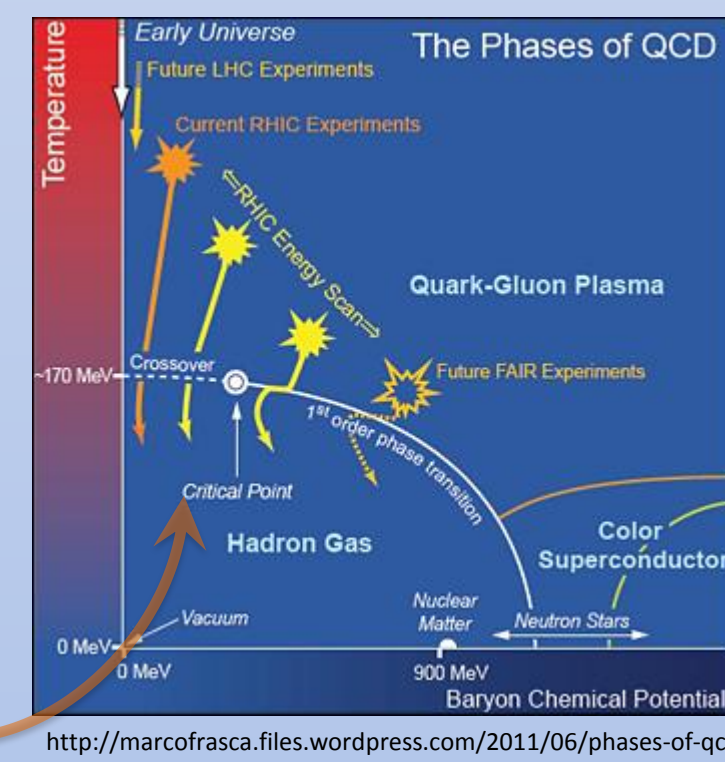

Collider-Accelerator Department injectors and RHIC.

Electron Parameters	Value
Electron Beam Energy	0.9-5 MeV
Charge per Bunch	0.5 – 1 nC
Electron Beam Current	10-50 mA
RMS Norm Emittance	≤ 2.5 mm mrad
Bunch Rep Rate	84 MHz
Bunch Train Rate	4.5 MHz
RMS Energy Spread	≤ 5 × 10 ⁻⁴
FWHM Bunch Length	700 ps
RMS Trans beam size	5 mm
e-beam power	250 kW

Ions with gamma = 4	Value
Particles per Bunch	0.75x10 ⁹
Peak Current	200mA
RMS Norm Emittance	15 mm mrad
Rep Rate	75.85 kHz
RMS Energy Spread	≤ 5 × 10 ⁻⁴
RMS Bunch Length	5.8m
RMS Trans beam size	5 mm
Space charge tune shift	0.019

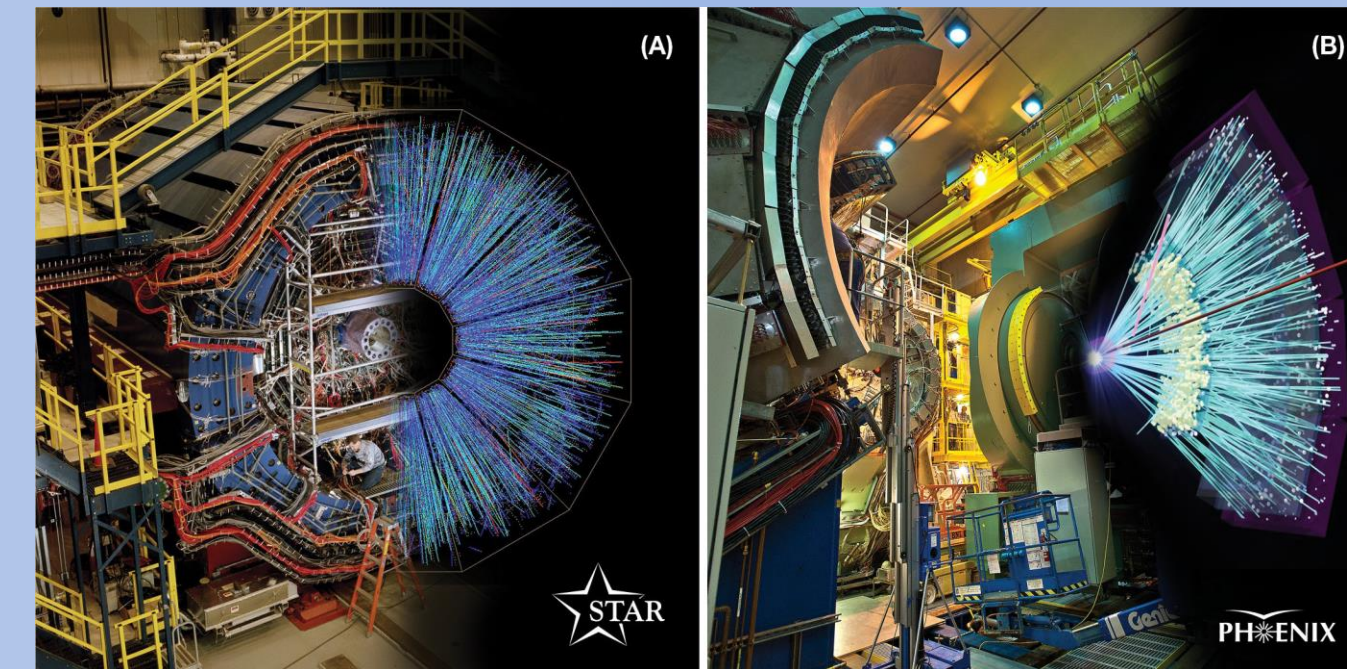
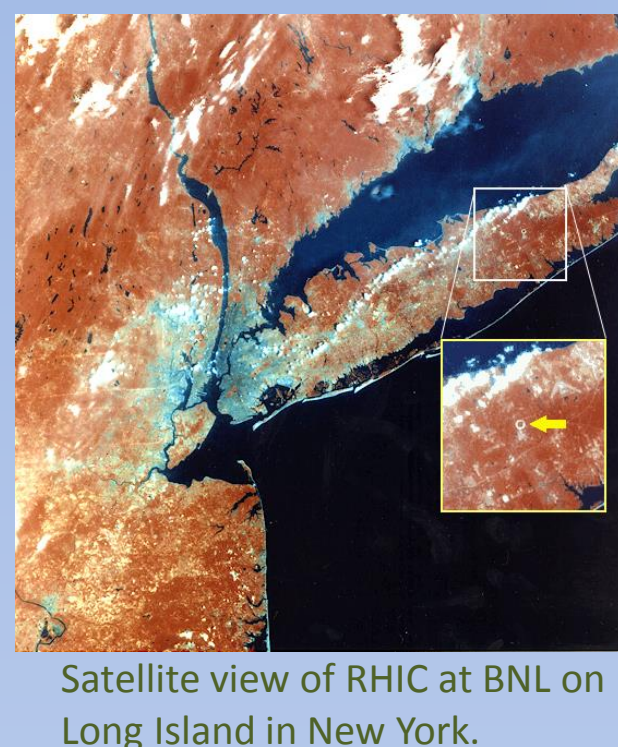
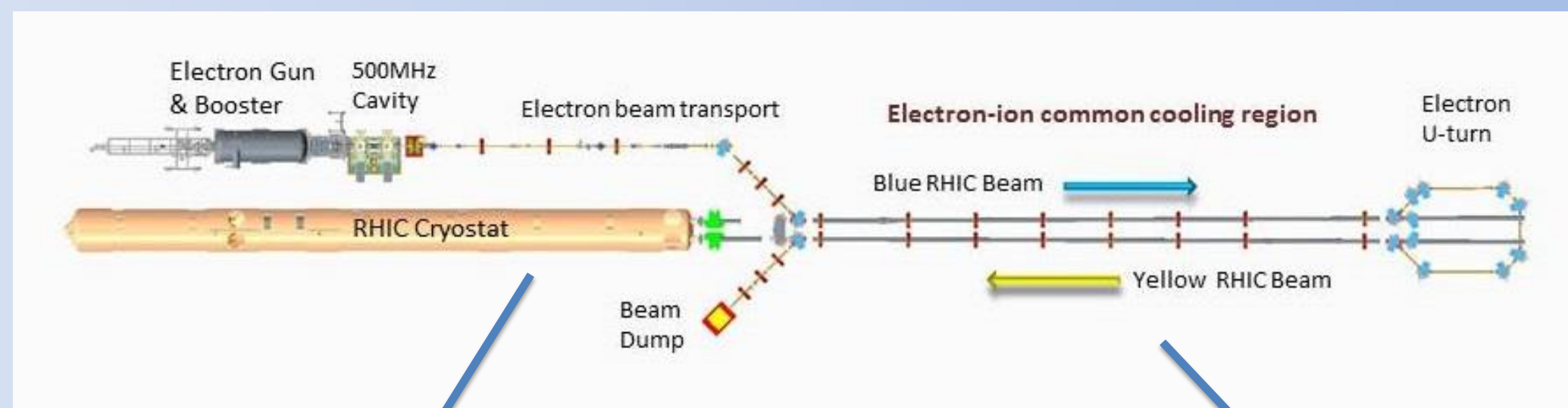

Figure 2: LEReC beam line layout. The adjacent 12m cooling sections will be located in a RHIC warm region.



Satellite view of RHIC at BNL on Long Island in New York.

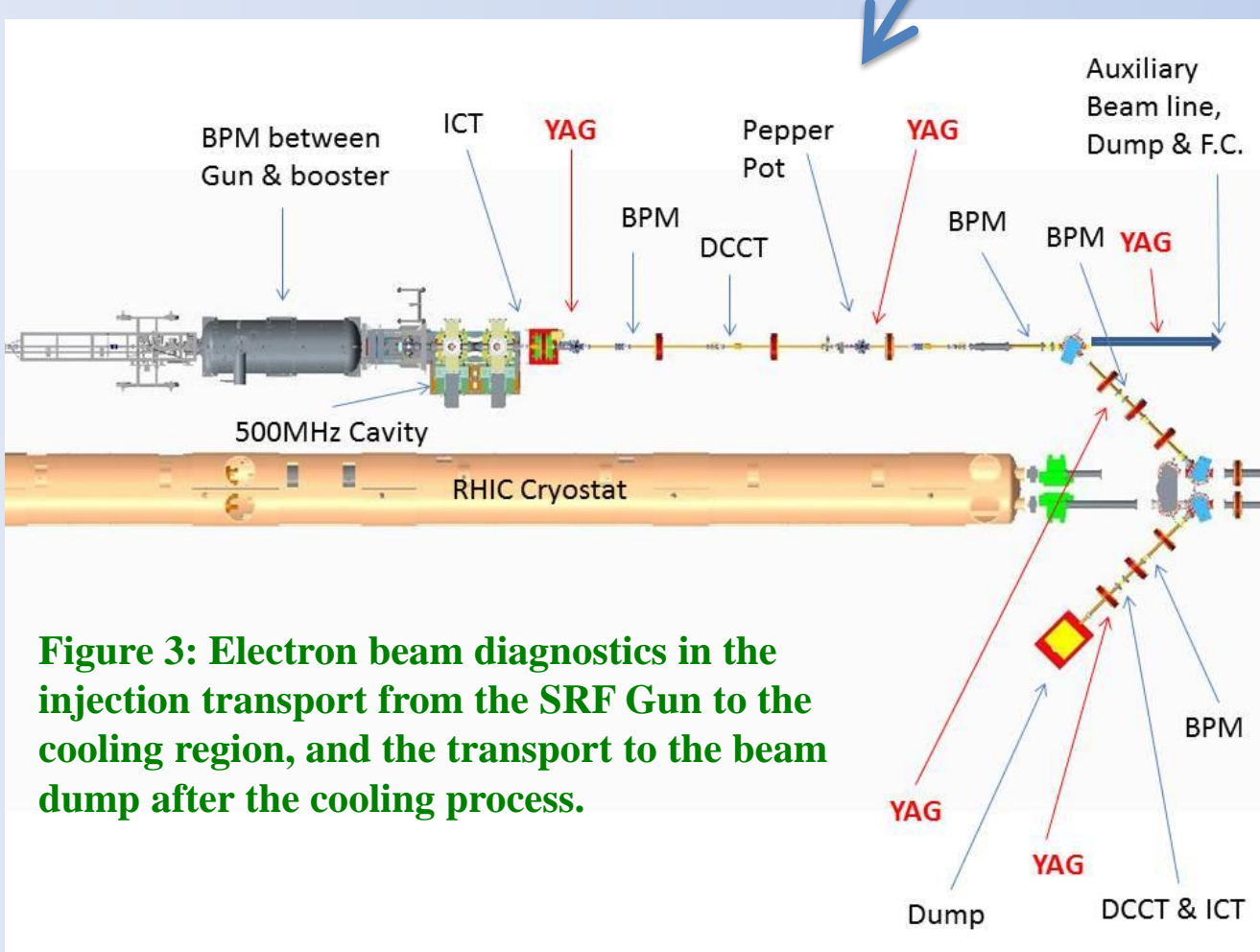

Figure 3: Electron beam diagnostics in the injection transport from the SRF Gun to the cooling region, and the transport to the beam dump after the cooling process.

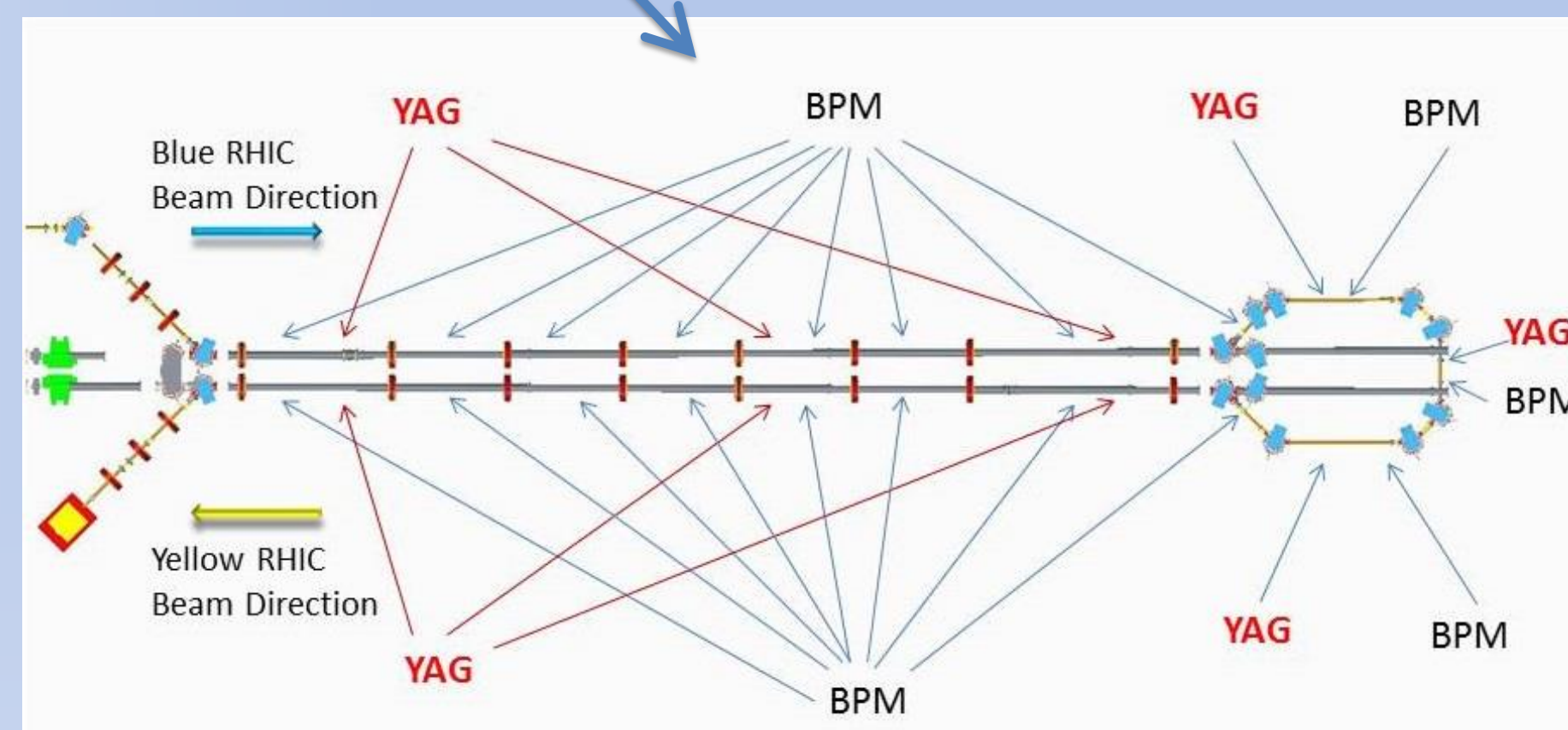

Figure 4: Electron beam diagnostics in the cooling and U-turn region, YAG is a screen transverse profile monitor.

Low Energy RHIC electron Cooling bunch configurations for a variety of ion bunch lengths and energies.

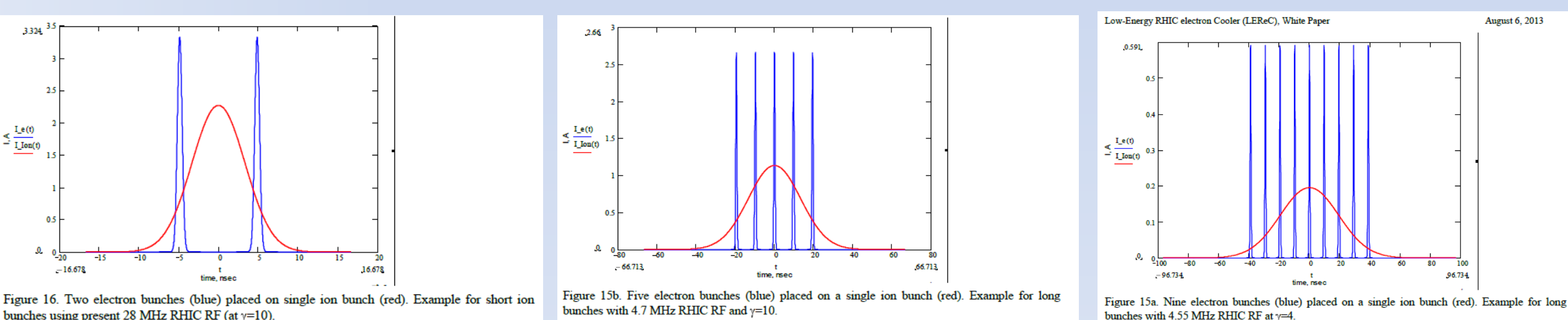

Figure 16. Two electron bunches (blue) placed on single ion bunch (red). Example for short ion bunches using present 28 MHz RHIC RF (at $\gamma=10$).

Figure 15b. Five electron bunches (blue) placed on a single ion bunch (red). Example for long bunches with 4.7 MHz RHIC RF and $\gamma=10$.

Figure 15a. Nine electron bunches (blue) placed on a single ion bunch (red). Example for long bunches with 4.55 MHz RHIC RF at $\gamma=4$.

ELECTRON BEAM DIAGNOSTICS

Electron Beam Position Monitors

As we are still in the early stages of the system design, the development of a detailed commissioning plan is still underway. There are 24 dual plane 15 mm diameter button style BPM pick-ups planned in the ~40 meter electron beam line. The position of the electron beam can be monitored using Libera Brilliance Single Pass [2] electronics from Instrumentation Technologies. Averaging position data over multiple passes and increasing number of bunches will increase the measurement accuracy. To measure the short electron bunches position while it co-propagates with the long ion bunches, electronics with an input band-pass filter frequency of 500 MHz can be used so the signal from the ion bunches (5m rms bunch length, 7.5e8 ions) that have lower frequency components will be suppressed. The ion beam position in the common cooling regions can be monitored by Libera Hadron [2] electronics connected to the same pick-up electrodes. These units will require lower band-pass filter frequency (10-100 MHz). The effect of the electron beam can be subtracted from the data from ion BPM receivers. Calibration can be done by running each beam independently. The electron-ion beam transverse alignment in the cooling section needs to be ~2% of the 5mm electron beam sigma, or ~100 microns.

Electron Beam Transverse Profile Monitors

Transverse beam profiles will be measured at a variety of pneumatically plunging stations using 0.1 X 30 mm YAG:Ce screens. Images from the YAG screens are transported through a mirror labyrinth to a GigE CCD camera in a local enclosed optics box.

Electron Beam Emittance

There are several techniques planned to measure beam emittance. The expected normalized emittance range is 2.5 mm-mrad. A pepper pot station will be used to measure the 5 MeV beam emittance in the injection transport. This station will be comprised a multi-position plunging tungsten mask with a slit pattern upstream of a YAG profile monitor. Additional measurements will be made by varying the Linac rf phase and analyzing the images on the downstream profile monitors.

Electron Bunch Charge and Current

Bunch-by-bunch & bunch train charge will be measured by a Bergoz [3] in-flange Integrating Current Transformer (ICT). Beam charge signals will be processed by standard BCM-IHR Integrate-Hold-Reset electronics feeding a beam synched triggered digitizer. The 10kHz measurement rate option will be used to increase the range of commissioning modes that this system will be compatible with. An ICT will be installed in the upstream portion of the 5 MeV transport, and another just upstream of the dump to allow monitoring of overall transport efficiency.

There will be a set of Bergoz NPCT DCCT's configured in differential mode, installed to measure the absolute beam current and transport efficiency, one near the injector and one near the dump. We plan to employ a similar system that is presently being designed for use at the BNL ERL [4].

Electron Beam Loss Monitors

Efficient beam transport needs to be maintained and elevated radiation doses need to be avoided in the electron beam transport and in the common sections. Photomultiplier tube (PMT) based loss monitors are a candidate detector and will be installed at a variety of locations. The design of the detector and signal processing electronics [5] is based on ones developed at Jefferson Lab and used at CEBAF. LEReC will plan to use the Hamamatsu R11558 PMT in the detectors.

Beam Dump Diagnostics

A water cooled dump will be designed to absorb the 250kW electron beam power. It will be modeled in general after the 1MW dump used for the BNL ERL [6] or after the Cornell ERL Dump, but will be optimized for the LEReC beams. We plan to further develop the LEReC beam dump diagnostics as we learn from experience during ERL Dump and Cornell Dump diagnostics commissioning. The planned diagnostics include thermocouples, loss monitors, screens and IR camera [7].

RHIC ION BEAM DIAGNOSTICS FOR LOW ENERGY COOLING

The primary diagnostics for monitoring of the cooling process will be the RHIC Wall Current Monitor [8] and Schottky monitors. A new wideband Schottky pick-up is being designed for improved monitoring of the longitudinal stochastic cooling characteristics that may also be useful for LEReC. The valuable experience gained using these instruments during the successful stochastic cooling commissioning and Coherent Electron Cooling Proof of Principle [9] will be applied to the LEReC effort. The existing RHIC DX BPMs will be used to center the 1x10⁹/bunch, 15 mm mrad rms norm emittance ion beam in the cooling regions. The RHIC closed loop orbit system will ensure ion beam position stability.

Recombination Measurement

We are considering methods to detect the number of Au ions after recombination as a means of measuring the cooling process efficiency. Our simulations show that without the suppression of recombination the resulting loss in integrated luminosity is negligible. Thus, for the baseline design approach we do not require undulators and will not have recombination suppression, this could be a possible future upgrade. Recombination simulations are planned to determine the possible beam loss locations of these ions with non-ideal charge states. The use of pin diode loss monitors and/or scintillators with PMT detectors located near the collimators is an early strategy.

REFERENCES

- [1] Fedotov, A. et. al., "Low-Energy RHIC electron Cooler White Paper", C-AD Note, August 6, 2103.
- [2] <http://www.i-tech.si/>
- [3] <http://www.bergoz.com/>
- [4] Cameron, P. et. al., "Differential Current Measurement in the BNL Energy Recovery Linac Test Facility", Newport News, Virginia ERL05.
- [5] Allison, T. et. al., "New Beam Loss Monitor For 12GeV Upgrade", WEP092, ICALPCS2009
- [6] Hershcovitch, A., "R&D ERL: Beam Dump", PAC99, C-A/AD/378 January 2010.
- [7] Miller, T. et. al., "Instrumentation Designs for Beam Distribution Measurements in the ERL Beam Dump at BNL", these proceedings.
- [8] Cameron, P. et. al., "The RHIC Wall Current Monitor System", WEA116, PAC99, page 2146.
- [9] Gassner, D. et. al., "Coherent Electron Cooling Proof of Principle Instrumentation Design", WEAP01, BIW2012