

DESIGN OF AN ULTRA-COMPACT STRIPLINE BPM RECEIVER USING MICROTCA FOR LCLS-II AT SLAC*

C.Xu, S. Babel, S. Hoobler, R. Larsen, J. Olsen, S. Smith, T. Straumann, D. Van Winkle, A. Young, SLAC National Accelerator Laboratory, Menlo Park, CA 94025, USA

Abstract

The Linac Coherent Light Source II (LCLS-II) is a free electron laser (FEL) light source. LCLS II will produce 0.5 to 77 Angstroms soft and hard x-rays [1]. In order to achieve this high level of performance, the beam position measurement system needs to be accurate so the electron beam can be stable. The LCLS-II stripline Beam Position Monitor (BPM) system has a dynamic range of 10pC to 1nC bunch charge. The system has a resolution requirement of 5µm [2]. The BPM system uses the MicroTCA (Micro Telecommunication Computing Architecture) physics platform that consists of an analog front-end (AFE) and a 16-bit analog to digital converter (ADC) module. This paper will discuss the hardware design, architecture, and performance measurements of this system using the SLAC LINAC. The hardware architecture includes a bandpass filter at 300MHz with 15 MHz bandwidth, and an automated BPM calibration process.

INTRODUCTION

The LCLS-II project is primarily modelled after the LCLS-I project design with enhancements and minor modifications. The LCLS-II project will be able to provide users with two independently controlled x-ray sources in a new undulator hall. It will be possible to simultaneously provide tunable hard and soft x-ray beams, one optimized for 250 to 2,000eV photons and the other optimized for 2-13keV photons. (Fig. 1) The high beam stability and accuracy needed for FEL generation requires the BPM system to meet the requirements shown in Table 1.

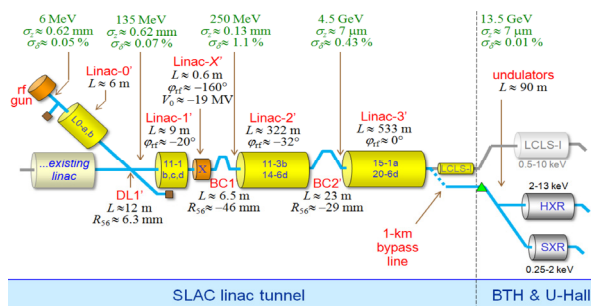

Figure 1: LCLS-II structure layout [2].

*Work supported by U.S. Department of Energy under Contract Numbers DE-AC02-06CH11357 and WFOA13-197

Table 1: Stripline BPM Operating Requirements [3]

Requirement	Value
Resolution and noise for single pulse measurement, over 10% of the aperture at 250pC	5 micron
Dynamic Range	0.01 – 1nC
Resolution and noise for charge < 250pC	1250/Q microns
Maximum drift	5 micron/hour
Maximum electrical offsets	100 micron
Maximum mechanical and alignment offsets	100 micron
Calibration scale error	< 10%
Charge sensitivity	< 5%RMS
2-bunch cross talk	10%
Repetition rate	120Hz

The BPM system provides repeatable transverse beam position data to the Main Control Center and the SLAC global feedback system. In order to meet the stringent requirements, the BPM system performs a self-calibration process between each beam pulse.

SYSTEM DESIGN

The stripline BPMs are installed in the injector, LINAC and transport line sections of the LCLS-II. The motivation for this new design is to have a compact stripline BPM system with high reliability and scalability, while maintaining the performance of original LCLS-I design. The system is realized using the MicroTCA platform with a SLAC built rear transition module (RTM) and Struck SIS8300 digitizer module sampling at 109MHz.

SLAC LINAC Stripline BPM Structure

Each BPM has a diameter of 0.87in with a 7% azimuthal coverage. There are four striplines inside the structure, spaced by 90 degrees. The striplines are 4.75in long. To verify each BPM structure does not exceed the maximum acceptable offset, each BPM is tested using a network analyzer. The network analyser measures the strip to strip coupling coefficient. To increase efficiency a Python script was created to

automate the testing process. Equation 1 shows the formula used to calculate the horizontal (X) and vertical (Y) axis offset. PCMM is the measured radius of the BPM structure and S represents the coupling coefficients between electrodes. [5]

$$\left[\frac{(S_{41}-S_{21})+(S_{43}-S_{23})}{S_{21}+S_{41}+S_{23}+S_{43}} \right] \times PCMM = offset(mm) \quad (1)$$

Analog Front End/Rear Transition Module

The analog front end (AFE) has four processing channels, one calibration network, and one Altera MAX-V CLPD controlling the variable attenuators and switches. (Fig. 2)

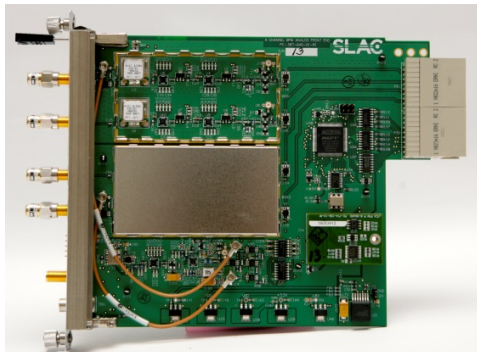

Figure 2: SLAC built BPM analog front end.

The original AFE processed the BPM signal at 140MHz, which is 35% of the maximum frequency response from the BPM structure. [4] The new AFE/RTM processes the BPM signal at 300MHz, where the signal amplitude is 4.6dB higher in comparison. (Fig. 3) The RTM's first stage bandpass filter is a 300MHz bandpass filter with 15MHz bandwidth. When the BPM doublet signal enters the RTM, the filter will create a 300MHz signal with amplitude proportional to the input signal amplitude. To meet the dynamic range requirement and maintain good linear response, there are two digital controlled

attenuators and two RF amplifiers. Each attenuator provides up to 31dB of attenuation in 1dB steps. The first stage amplifier provides 16dB gain, and the second stage amplifier provides 20dB gain. Before the signal is sent to the ADC module, there is a 300MHz anti-aliasing filter with 60MHz bandwidth. After the anti-aliasing filter, the signal is converted from single end to differential using a transformer.

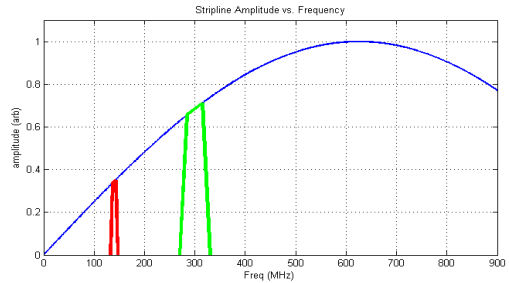

Figure 3: BPM structure frequency response.

The RTM performs a self-calibration process at 120Hz by injecting a 300-MHz tone at a known amplitude into one stripline of each plane. The Y-plane tone calibrates the X-plane via stripline to stripline coupling and the Y-plane is calibrated via injecting a tone on the X-plane. Figure 4 shows the X-plane calibration process. The state-machine inside the CLPD controls the switches and RF amplifier to perform the calibration process.

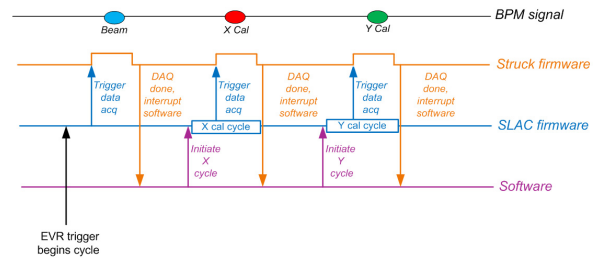

Figure 4: 120Hz beam-calibration cycle.

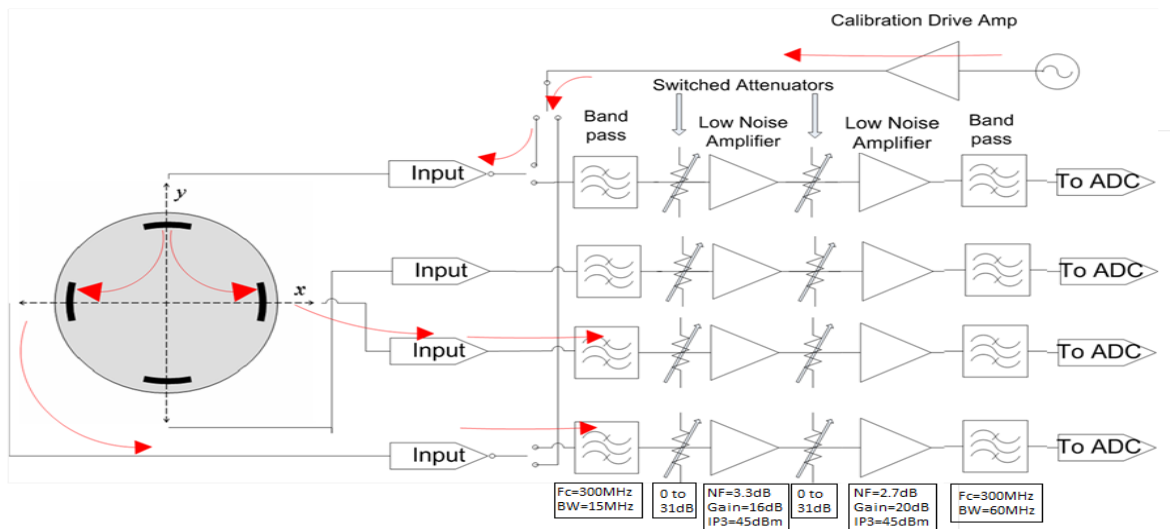

Figure 5: BPM calibration process.

Digitizer and Sampling Theory

The BPM system uses a Struck SIS8300 ADC module. The SIS8300 is a 125MSPS 16bit 10 channel ADC module. (Fig. 6)

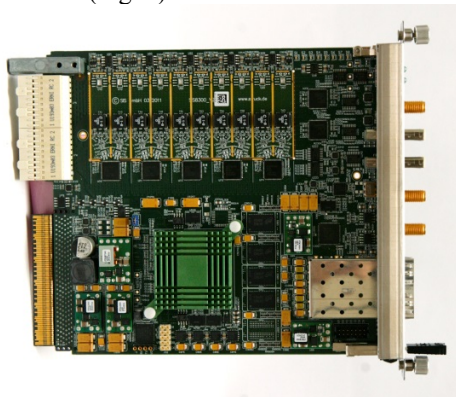

Figure 6: Struck SIS8300 digitizer.

To sample the BPM signal, a bandpass sampling technique is used with a custom clock frequency. An ADC samples all frequencies within the ADC's analog input bandwidth. These input frequencies are all aliased into the Nyquist band of the ADC. With careful pre-filtering, only the frequencies of interest are being sampled. To capture the maximum BPM signal, the alias image should be placed in the middle of the first Nyquist zone. The best choice of sampling frequency is 109MHz and thus the Nyquist zone is 54.5MHz wide. A 300MHz signal creates a 27.5MHz alias signal, which is placed in the middle of the first Nyquist zone. (Fig. 7)

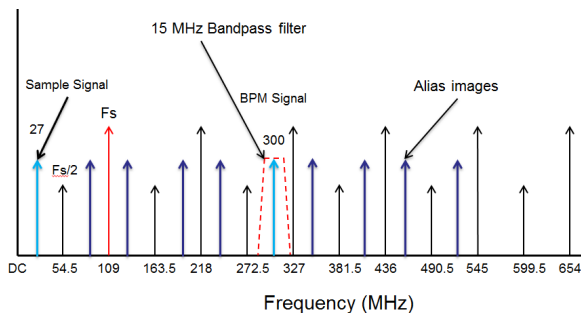

Figure 7: Using a 109MHz clock places the 300MHz signal in the first Nyquist zone.

If any of the original signal leaks into the adjacent Nyquist zone, then the image will be aliased to the first Nyquist zone. This will decrease the signal quality. To prevent the signal from leaking to the adjacent Nyquist zone, the first stage band-pass filter has a second cut-off requirement. 327MHz and 272.5MHz are the edges of the sixth Nyquist zone. The bandpass filter has a 40dB attenuation at 272.5MHz and 30dB attenuation at 327MHz.

Graphical User Interface (GUI)

The GUI is created using the EPICS EDM tool. (Fig. 8) The GUI displays the calculated X, Y position,

calibration waveforms and digitized signals. It also provides user control of the attenuators' attenuation setting.

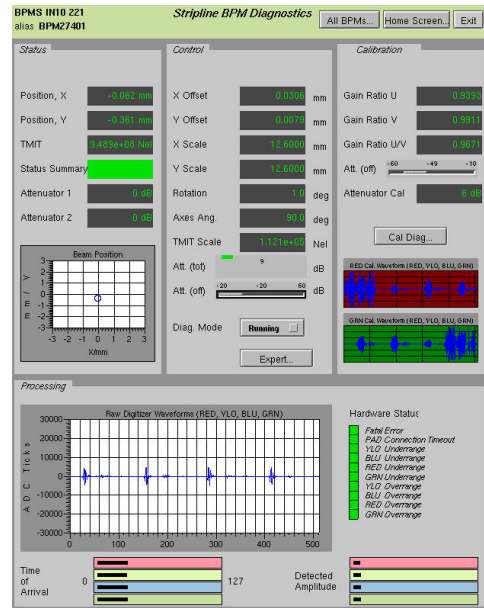

Figure 8: EPICS EDM user interface.

TEST RESULTS

Three BPMs were installed into the LCLS-I LINAC in December 2012. Since then, the three BPMs have been collecting data like other BPMs. A dynamic range and resolution study was conducted in winter 2012. Figure 9 shows the dynamic range result from 12pC to 350pC bunch charge. BPM27201 - 27401 are using the newly installed BPM system.

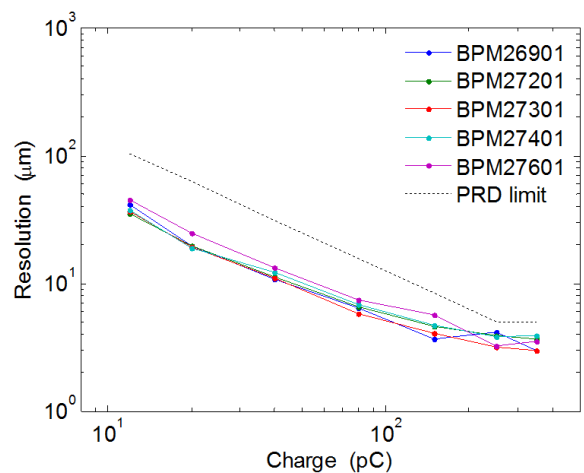

Figure 9: Dynamic range study result.

Figure 10 shows the calculated resolution for the BPMs in the entire L3 section of the LINAC at 250pC bunch charge. The new BPM system was able to produce position resolution between 2.8µm and 3.5µm, meeting the requirement of 5µm. Despite the fact that the new RTM has less gain due to space constraints, it performs as well as the original design. In January 2013, another

resolution study was performed at 10pC bunch charge. The new system produced 35 μm resolution, for a requirement of 125 μm .

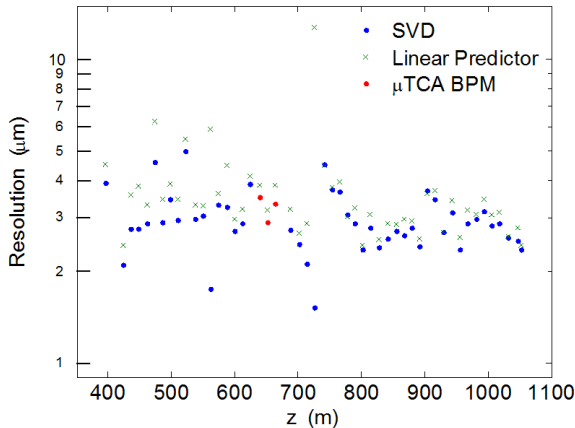

Figure 10: BPM resolution of the entire L3 section of the LINAC.

To achieve the best result possible. A higher gain RF amplifier was put into the RTM, increasing the second stage amplifier gain to 20dB. Lab test was done on the modified RTMs. Lab test result showed at 150pC bunch charge, the modified RTM was able to achieve $\sim 3\mu\text{m}$ resolution. The result was 5 μm better than the requirement.



Figure 11: Seven BPM systems operating in a 12 slots ELMA crate.

MicroTCA Platform

The MicroTCA platform is more compact and offers robust system architecture. It also significantly increases real-time processing power and data transfer bandwidth. For the LCLS-II injector stripline BPM system, SLAC has tested many MicroTCA modules. The BPM system is currently using: ELMA 12-slot crate, NAT mTCA.4 MCH, Wiener 800W Power supply, Struck SIS8300 ADC, MRF PMV EVR, and Vadatech AMC100 PMC carrier. This configuration has allowed the BPM system to have eight RTM and eight SIS8300 in a single crate. (Fig. 11) Each pair of modules consumes $\sim 70\text{W}$ of power. The Wiener power supply is the only power module that has the power handling capability and has the fewest IPMI communication issues with the MCH. The Struck firmware has been modified to include an SPI interface for the RTM and does block DDR writes.

Acknowledgement

The author would like to thank Henrik Loos (SLAC), Thomas Himel (SLAC), Matthias Kirsch (Struck), Andreas Ruben (Wiener), and the BPM team whole helped to make this project successful.

REFERENCES

- [1] P. Emma, "First Lasing of the LCLS X-Ray FEL at 1.5 Å", PAC09, May, 2009
- [2] S. Smith, "LCLS-II Beam Position Measurement System Requirements", SLAC document number: SLAC-I-060-103-007-00-R001, June, 2012
- [3] T. Raubenheimer "Linac Coherent Light Source II Preliminary Design Report – Accelerator Overview & Accelerator Physics", SLAC document number: SLAC-I-060-004-000-03-R000, June, 2012
- [4] E. Medvedko, "New Beam Monitoring Instrumentation at ATF2, KEK", BIW2010, May, 2010
- [5] Private communication with J.-L. Pellegrin "Procedure for the Calibration of the LINAC BPM's Using a Network Analyzer".