

STREAK CAMERA IMAGING AT ELSA*

M. Switka, M. Schedler, S. Zander and W. Hillert, ELSA, Bonn, Germany

Abstract

The Electron Stretcher Facility ELSA provides spin polarized and unpolarized electrons with energies up to 3.2 GeV for external hadron physics experiments. In order to suffice the need of stored beam currents towards 200 mA, studies of instabilities and the effect of adequate countermeasures are essential for appropriate machine settings. For this purpose a new diagnostic beamline has been constructed. It is optimized for transverse and longitudinal streak camera measurements with time resolution down to one picosecond. Operation of the diagnostic beamline has recently started and first measurements are presented.

INTRODUCTION

ELSA [1] is operated by the University of Bonn within DFG's collaborative research center "Subnuclear Structure of Matter". The accelerator consists of three stages as illustrated in Fig. 1. The last stage is a pulse stretcher ring attaining final beam energies between 0.5–3.2 GeV. The electrons can be stored or slowly extracted. Extraction currents around 1 pA are available at the moment. An increase by one order of magnitude is planned.

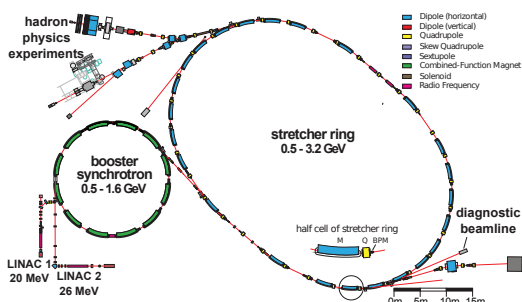

Figure 1: The Electron Stretcher Accelerator ELSA.

A newly installed beamline extends the optical beam diagnosis capabilities for the stretcher ring. It accommodates a streak camera most sensitive to the visible spectrum. The optical beamline is designed for transverse streak camera imaging in addition to its generic longitudinal diagnosis capabilities. Observation time scales available range down to one picosecond. Measurements of single bunch lengths, charge distributions and beam dynamics are subject of analysis. It is expected that these time-resolved observations help enhancing the machine settings to encounter instabilities. At present commissioning for transverse streak camera imaging is in progress. Therefore first

longitudinal beam profile measurements are presented in this proceeding.

BEAMLINE

The synchrotron light generated in a bending magnet propagates through a 12 m long evacuated section until it is reflected downwards by the primary reflecting mirror. It exits the vacuum through a fused silica glass window and enters a compact light sealed box (Fig. 2). The beamline is not equipped with a radiation shielding chicane and is therefore located in a radiologically controlled area. This requires some automatization for beam adjustment and diagnostic tools that are remote controllable over long distances (>100 m).

The primary mirror absorbs most of the synchrotron light, including X-ray radiation. Despite of the stress due to water cooling and irradiation heating. However, the preservation of its excellent optical properties is granted by a careful design based on FEM¹ analysis. [2] Blackening protection is granted by an ultra-high vacuum environment. The length of the beamline allows for differential pumping in order to gain approximately two orders of magnitude in pressure.

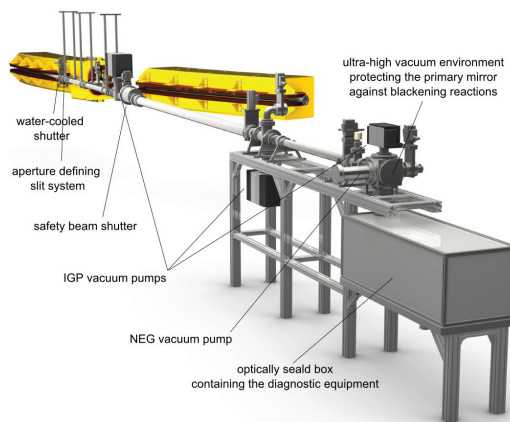

Figure 2: Synchrotron radiation beamline with compact and optically sealed box containing the diagnostic equipment.

Beam Modulation Section

All optical components and diagnostic instruments are installed on a $150 \times 60 \text{ cm}^2$ optical table. The optics layout is illustrated in Fig. 3. The secondary reflecting mirror deflects the synchrotron light sideways into the optics plane, thus causing an image rotation of 90° . The primary focussing lens ($f = 1000 \text{ mm}$ at $\lambda = 530 \text{ nm}$) is located

* Funded by DFG (German Research Foundation) within SFB/TR 16

¹Finite element method

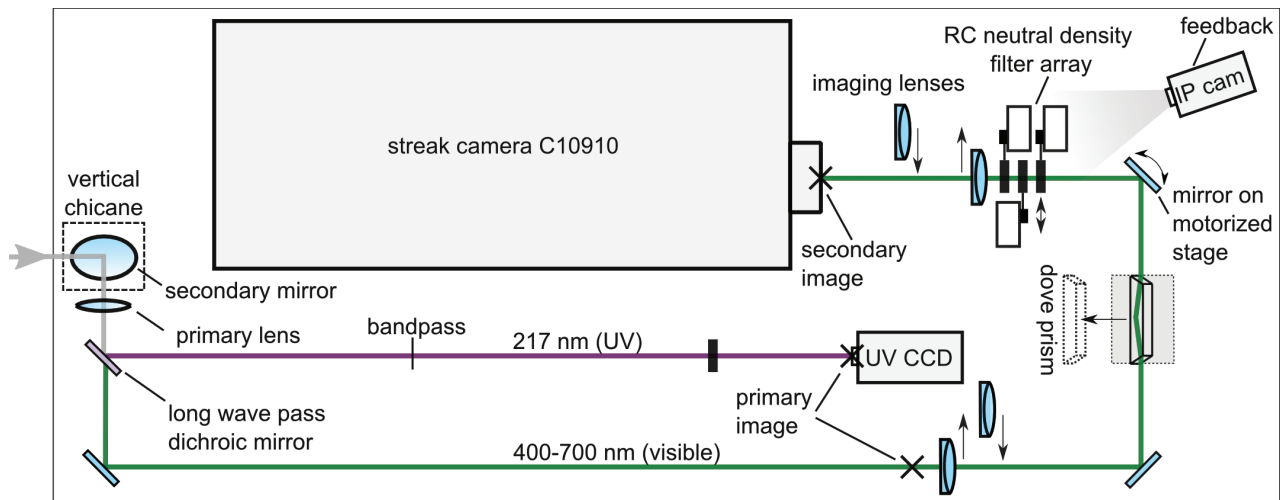

Figure 3: Optics layout roughly to scale. A dichroic mirror separates the UV from visible synchrotron radiation. The visible part can be magnified, attenuated and rotated. An IP camera provides aiming feedback.

right after the secondary mirror. A long wave pass dichroic mirror separates the UV light and deflects it towards a UV sensitive CCD camera. It serves as beam position monitor and emittance measurement tool [3]. The visible light components penetrate the dichroic mirror and are reflected into the streak camera. On its way the beam can be magnified, attenuated and rotated. Broadband optical components (400–700 nm) ensure maximum intensities deliverable. Collimation of the primary real image is done by a convex lens with either $f = 50$ mm or $f = 65$ mm focal length. The parallel light bundle is refocused downstream onto the streak camera’s input optics with lenses of $f = 100$ mm or $f = 200$ mm focal length. This forms a secondary real image with adjustable final magnification of $M = 0.35, 0.27, 0.17$ and 0.13 . The lenses are installed on motorized flip mounts allowing for automatic modulation. An array of neutral density filters is installed similarly. The streak camera can only display one transverse plane at a time. A Dove prism tilted by 45° can be inserted on a motorized linear stage in order to rotate the beam by 90° . Thus allowing imaging of both transverse planes. As mentioned above remote controlled adjustment of several optical elements is required. This includes the adjustable streak camera’s input slit. Stepper motors control slit width and height. An IP camera films the setting providing visible feedback to the control room.

STREAK CAMERA

System Setup

The installed streak camera is the all-purpose model C10910 by Hamamatsu. It is expected to provide a time resolution below 1 ps FWHM [4] and can be located more than 100 m away from its control computer – bridging of FireWire, Ethernet and USB connections occurs via fibre cables and corresponding patch panels. A block diagram is illustrated in Fig. 4.

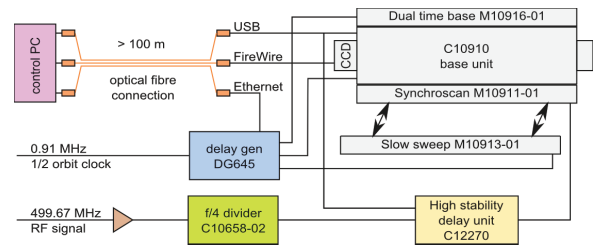

Figure 4: Streak camera block diagram.

A list of available sweep units and corresponding sweep times are shown in Table 1. The synchroscan unit M10911-01 is operated at 1/4 of the 499.67 MHz cavity RF. After multiple bunch train revolutions yet every 2nd bunch is repetitively displayed on the falling slope since ELSA’s harmonic number is $h = 274$. The rising slope creates a mirrored image. The high stability delay unit C12270 locks the phase and prevents phase shifts during long-term measurements (e.g. due to temperature changes). The phase can be modified manually in order to separate the images vertically. The dual time base extender unit M10916-01

Table 1: Available Sweep Units with Corresponding Time Scales and Purpose

Sweep Unit	Sweep Range	Field of Study
Synchroscan	100 ps – 1.3 ns	Charge distribution
Dual time base	60 ns – 100 ms	Long. dynamics
Slow Sweep	1.2 ns – 1 ms	Transv. dynamics

performs linear sweeps along the second screen axis and separates the vertical streak images horizontally. It is triggered by every second orbit clock signal (0.91 MHz). This assures that only one bunch illuminates the same spot. The sweep repetition of this unit is limited to 10 Hz. The synchroscan unit is exchangeable with the linear slow sweep

unit M10913-01. It displays the continuous bunch train in a vertical streak. This allows the study of beam dynamics in the transverse planes.

First Measurements & Status Quo

The beam modulation section is yet in its commissioning stage. First measurements were performed without focusing lenses, hence typical integration times in pure synchroscan mode were approximately 3 s. Figure 5 shows bunch length measurements with respect to beam energy. The filling pattern was uniform and 25 mA of stored beam were accumulated.

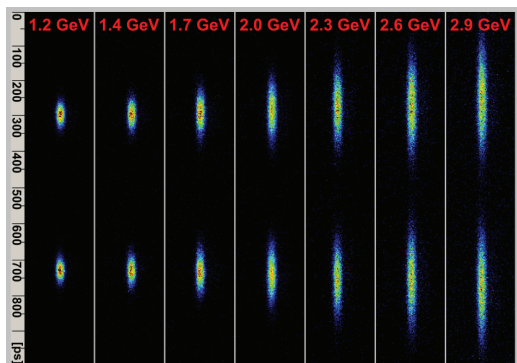

Figure 5: Bunch length measurements at different beam energies using the synchroscan unit.

The cavity voltage U_0 remained constant, causing the overvoltage factor q to decrease and the acceleration phase to increase with rising beam energy. Bunch length and phase shift match the expected values (compare Fig. 6). Note that the discontinuance in Fig. 6b is due to manual phase adjustment in order to fit the screen.

The performance of the multi-bunch feedback system [5] is demonstrated in Fig. 7. The attempt to kick out all bunches but one is recorded in a slow sweep image (Fig. 7a). The finite bandwidth of the feedback system's RF amplifier is responsible for the survival of neighbouring bunches; a circumstance that is not of limiting nature

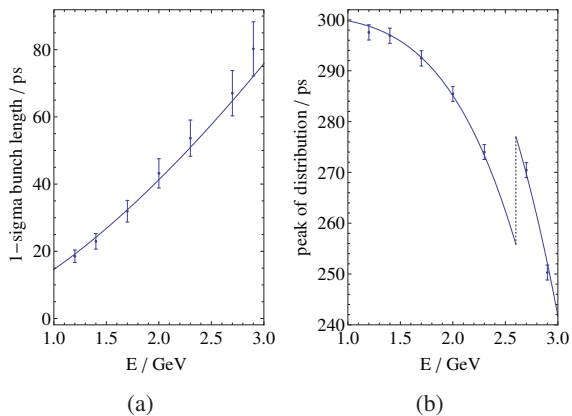

Figure 6: The dependency of bunch length and phase shift on beam energy matches the expected values.

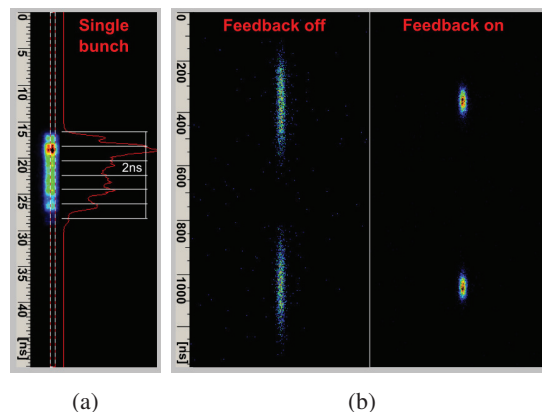

Figure 7: Performance of the multi-bunch feedback system. Single bunch operation and damping longitudinal coherent oscillations at 1.2 GeV.

during normal operation. A true single bunch operation is planned once construction of a new injector LINAC is completed. The smearing of this image is due to a finite rise time of the orbit clock signal which caused a large trigger jitter (< 1 ns). The signal generator was upgraded in the meantime and better resolution is expected for future operation. Figure 7b demonstrates the feedback system's damping power for coherent longitudinal oscillations. With the feedback system switched off large oscillation amplitudes of multiple bunch lengths arise. This is observed as smearing of the streak image in comparison to the damped case when the feedback system is switched on. The measurement was performed at 1.2 GeV beam energy with an overvoltage factor of $q \approx 157$.

SUMMARY

The streak camera system has been successfully installed and first images with long integration times could be recorded. For the first time measurements in the picosecond time domain were performed at ELSA. Images of transverse and longitudinal beam dynamics with much shorter integration times are expected to be recorded before 2014. Single bunch measurements will reveal machine parameters such as the longitudinal effective impedance once construction of the single bunch injector is completed.

REFERENCES

- [1] W. Hillert, The Bonn Electron Stretcher Accelerator ELSA: Past and future, *Europ. Phys. Jour. A28* (2006) 139
- [2] S. Zander, et al. , A New Diagnostic Beamline at ELSA, contribution IPAC 2012, New Orleans
- [3] S. Zander, et al. , High Resolution Synchrotron Light Analysis at ELSA, contribution IPAC 2013, Shanghai
- [4] Streak camera C10910 data sheet, <http://www.hamamatsu.com/resources/pdf/sys/e.c10910.pdf>
- [5] M. Schedler, et al. , Broad and narrow band feedback systems at ELSA, contribution IPAC 2013, Shanghai