

UPGRADE OF THE HIT INJECTOR LINAC-FRONTEND

S. Yaramyshev, W. Barth, M. Maier, A. Orzhekhovskaya, B. Schlitt, H. Vormann, GSI, Darmstadt
 R. Cee, A. Peters, HIT, Heidelberg

Abstract

The Therapy Linac in Heidelberg (HIT) was successfully commissioned in 2006. Required beam parameters were reached except for the beam intensity. The achieved particle transmission for C^{4+} (design ion) is significantly lower than design. Particle losses are mainly observed in the RFQ. One critical point is the matching section of the RFQ electrodes - Input Radial Matcher (IRM). The original design requires too rigid and narrow beam Twiss-parameters at the RFQ entrance. Also the measured emittance is about twice higher compared to the design. Numerically and experimentally it was proven that the solenoid, used for the beam matching to the RFQ, is not able to provide for the necessary beam size and convergence. As it was shown by beam dynamics simulations using the code DYNAMION, a minor modification of the IRM allows for an improvement of the beam transmission (up to 50%). The proposed measure was realized for an advanced HIT-RFQ-layout, which is recently under test stage. The same modification is already proposed for the linac frontend at Italian Hadrontherapy Center (CNAO, Pavia).

INTRODUCTION

The Heidelberg Ion-Beam Therapy Centre (HIT) is the first in Europe dedicated clinical synchrotron facility for cancer therapy using high energy proton and ion beams (C, He, and O) [1]. The accelerator comprises a 7 MeV/u, 217 MHz injector linac and a 430 MeV/u synchrotron. Installation and commissioning of the linac were performed in three phases: ion sources and LEPT, 400 keV/u RFQ, and 20 MV IH-type drift tube linac (Fig. 1). The commissioning of the linac was successfully finished in December 2006 [2].

To provide for the designed intensities, a linac upgrade program has been initiated. Yet the overall achieved transmission through the injector linac is about 30% (C^{4+} design ions), mainly due to a mismatch of the beam at the RFQ entrance. Thus a detailed upgrade program has been started to exchange the RFQ with a new radial matcher design, to correct the misalignment and to optimize beam transition to the IH-DTL. The aim is to achieve a sufficient overall linac transmission above 60% [3,4].

The main goal of the beam dynamics study with the DYNAMION code [5] was to estimate the maximum possible transmission for the HIT linac front-end system, namely for the matching solenoid and the RFQ. The commissioning results before the matching solenoid showed good coincidence with previous design calculations. As a first step, an adequate description of the linac elements was carried out. Specifications of the RFQ [6] and of the solenoidal field, available from the measurements or external calculations, were used for the simulations. Additionally, the measured misalignments of the linac elements were taken into account.

Emittance Measurements

During commissioning emittance measurements were performed behind the LEPT (without installation of the RFQ). The distance from the solenoid to the RFQ entrance is only about 10 cm; the emittance measurement device (slit-grid) was positioned 50 cm behind the solenoid. The magnetic field of the solenoid was varied in the range from 40% to 60% of the nominal value to provide for a reasonable beam size at the slit position. The measured horizontal total beam emittance (Fig. 2) is about 300 mm·mrad for 90% level of intensity ($^{12}C^{4+}$; 200 μA). The measured vertical emittance is similar.

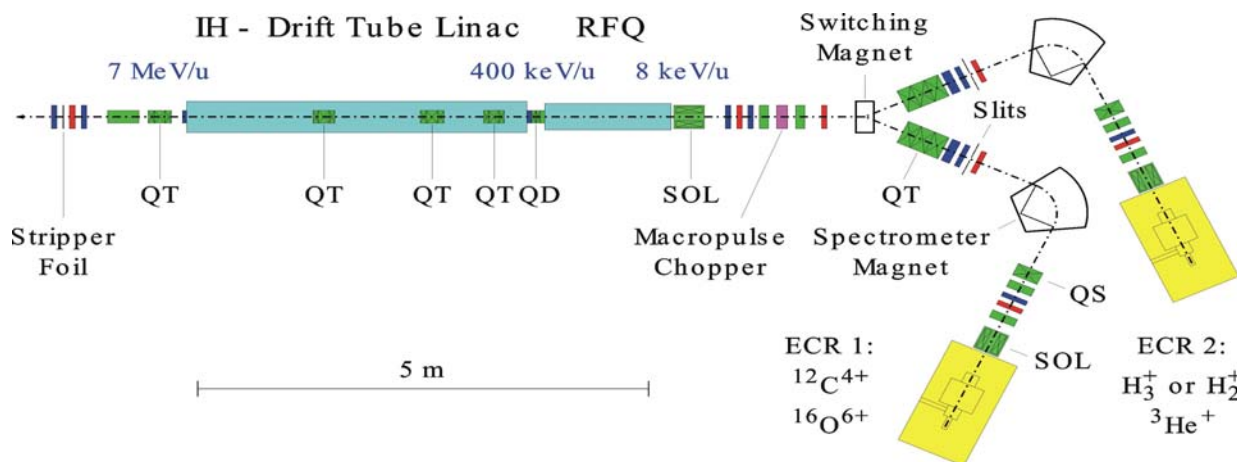

Figure 1: Layout of the HIT Injector Linac; SOL - solenoid, QD - quadrupole doublet, QT - quadrupole triplet.

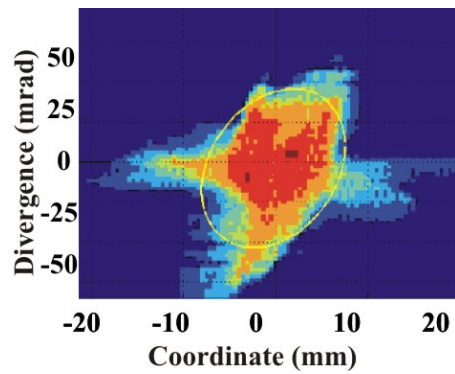

Figure 2: Measured beam emittance in the horizontal phase plane behind the matching solenoid ($^{12}\text{C}^{4+}$, 200 μA).

Input Macroparticle Distribution

A dedicated procedure for the reconstruction of the particle distribution, based on emittance measurements, was developed (Fig. 3).

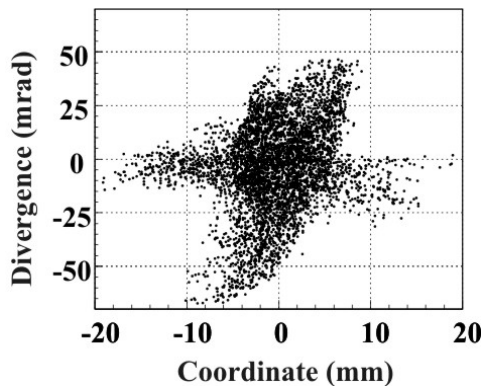

Figure 3: Macroparticle distribution based on the measured emittances ($^{12}\text{C}^{4+}$, 200 μA).

Magnetic Field of the Solenoid

Data of the magnetic field measurements along the matching solenoid were used for the reconstruction of the complete solenoidal field. As measurements were done only for dedicated points along the axis, a relaxation scheme was implemented to interpolate the magnetic field at each node of 3D field mapping. A dipole component in the field distribution was observed (Fig. 4). During commissioning the solenoid was transversally tilted to compensate the influence of the dipole component (steering) on the particle motion. Taking into account the measured displacement of the solenoid and the measured non-uniformity of the field, the particle motion was simulated backward through the solenoidal B-field as it was set during the measurements.

In 2007 the matching solenoid was replaced by a new one with improved quality of the magnetic field distribution. Nevertheless, earlier calculations of the HIT front-end particle transmission did not show an essential difference between ideal (axis-symmetrical) and real solenoidal field (with recent settings of the machine). It can be assumed that the dipole field component in the real solenoid is partly compensated by its tilt.

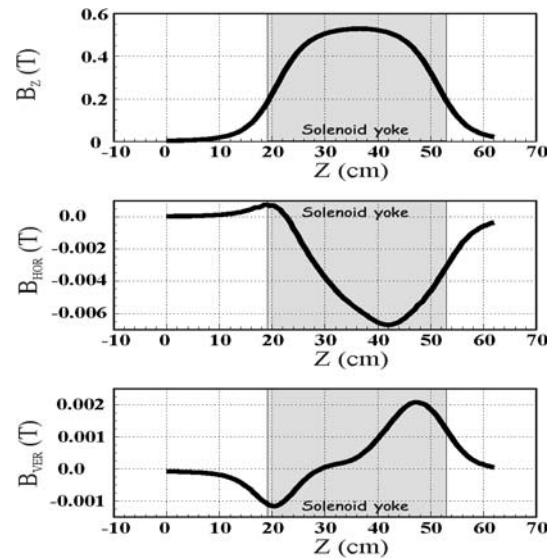

Figure 4: Measured magnetic field of the solenoid; longitudinal (top), horizontal (middle) and vertical (bottom) component on axis.

Representation of the RFQ

Available geometrical data from the specifications (cell length, aperture, width and rounding of the electrodes) were used for an advanced RFQ description. Dedicated subroutines of the DYNAMION code precisely calculate the 3D electrical field, solving the Laplace equation for the potential:

- RFQ Input Radial Matcher (IRM): The area for the grid is formed by the surface of electrodes / flange of the tank. 3D mapping of electrical field is calculated and used for the simulations.
- RFQ regular cells: The area for the grid for each cell is formed by the surface of the modulated electrodes; the potential is approximated with a classical 8-term series assuming the quadrupole symmetry; coefficients of the series are introduced into calculations as input data; 3D electrical fields are calculated as corresponding derivatives of the potential.
- DTL gaps (rebuncher section): The area for the grid is formed by the surface of the tubes; the potential and the 3D electrical fields for each gap, including the slack of the field into tubes, are approximated with 30-term series assuming an axial symmetry; coefficients of the series are introduced as input data.

RFQ ACCEPTANCE

A normalized acceptance V_k for each regular RFQ cell can be calculated from the solution of the Floquet equation as $V_k = v_f (a^2 / \lambda)$, where v_f is the minimum of the phase advance μ on the focusing period, a - aperture of the cell, λ - wave length of the operating frequency [7]. The local acceptance along the HIT-RFQ for C^{4+} beam is shown on Fig. 5. The minimum value (dashed line)

corresponds to 327 mm·mrad (total, unnormalized) at the RFQ input energy of 8 keV/u.

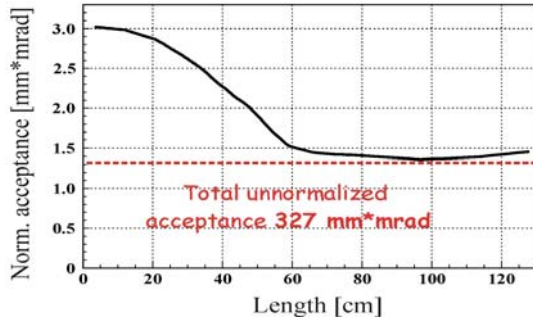

Figure 5: Local acceptance along the HIT-RFQ; the dashed line shows the unnormalized total RFQ acceptance related to the input energy.

The orientation of the acceptance at the RFQ entrance was calculated by a dedicated code [8]. It provides for backward transformation of the beam envelopes, matched at the first regular RFQ cell, taking into account the given shape of the Input Radial Matcher.

Alternatively, the RFQ acceptance can be obtained from the beam dynamics simulations using a wide four-dimensional grid in the transverse phase space as an input particle distribution. In the DYNAMION code each particle has a unique ID-number. The particles, accelerated to the final RFQ energy, are selected in the input distribution and represent the acceptance at the RFQ entrance (Fig. 6).

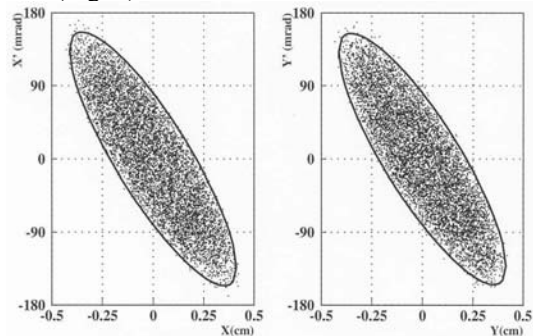

Figure 6: Simulated horizontal and vertical RFQ acceptance; ellipses correspond to 99% of intensity.

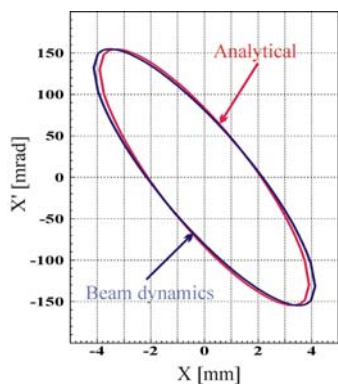

Figure 7: The horizontal acceptance at the HIT-RFQ entrance calculated analytically and obtained from beam dynamics simulations.

The "simulated" acceptance for both transverse planes is about of 330 mm·mrad, what corresponds well to the analytical calculations of the minimum local acceptance along RFQ (Fig. 7).

THE RFQ TANK DEFORMATION

During commissioning the alignment of the electrodes has been checked and a strong bending due to mechanical stress on the structure was observed. Such deformation is measured also for the CNAO RFQ [9]. A new robust tank design with thicker walls (6 mm instead of 4 mm), extra supports and 3 instead of 4 fixation points should solve this problem. The electrodes measured of the CNAO-RFQ have a maximum vertical misalignment of 0.8 mm. Dedicated beam dynamics simulations were performed assuming a sinusoidal shape of electrodes $d = 0.8 \sin(\pi z/L)$, where L is the length of the electrodes.

For the simulations the regular electrodes are represented by a set of 10 linear parts; each part (also IRM) has a vertical shift and tilt (Fig. 8).

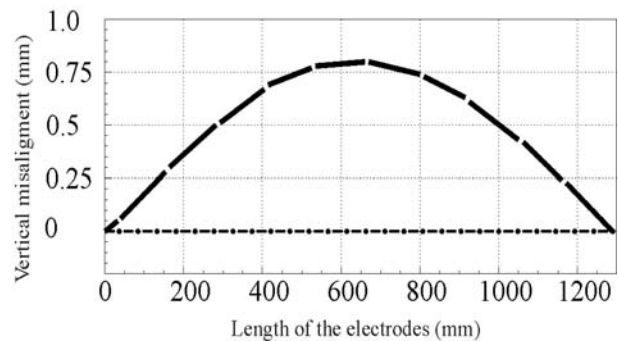

Figure 8: Representation of the HIT-RFQ misalignment, assumed for beam dynamics simulations.

Applying the above described procedure, the acceptance of the deformed RFQ was calculated using the results of beam dynamics simulations (Fig. 9). For the normal case an RFQ acceptance is about 330 mm·mrad for both transverse planes, while in case of the deformed electrodes it is about 180 mm·mrad only.

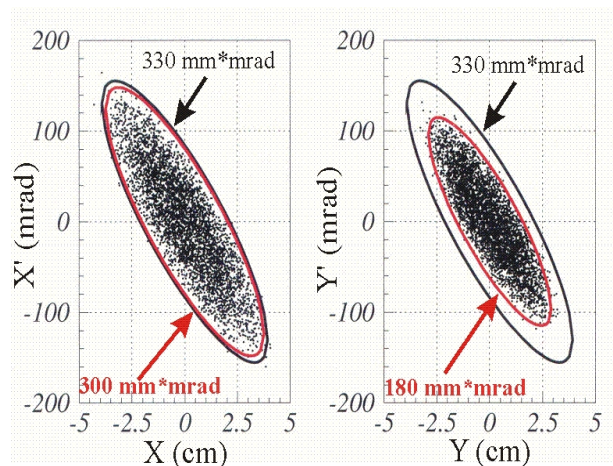

Figure 9: The horizontal and vertical RFQ acceptances with ideal (black) and deformed (red) electrodes.

FRONT-END BEAM DYNAMICS SIMULATIONS

Forward simulations through the matching solenoid with the measured field (design value), the measured tilt and using the reconstructed particle distribution were performed. An ideal alignment of the electrodes was assumed for this study. The calculated horizontal macroparticle distribution at the RFQ entrance is shown on Fig. 10; vertical one is similar. The ellipse represents the RFQ acceptance.

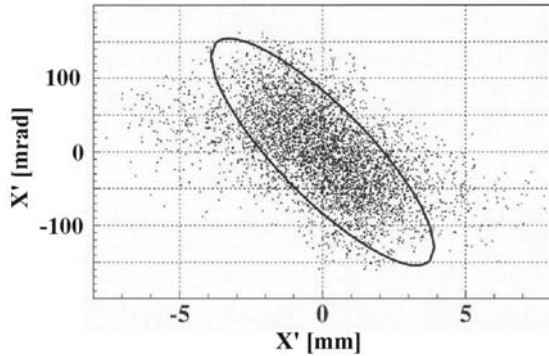

Figure 10: The calculated horizontal macroparticle distribution at the RFQ entrance.

A significant number of particles are outside the acceptance even with similar values of beam emittance and RFQ acceptance. This mismatch was illustrated by simulations of the RFQ transmission with C^{4+} ions varying the magnetic field of the solenoid (Fig. 11).

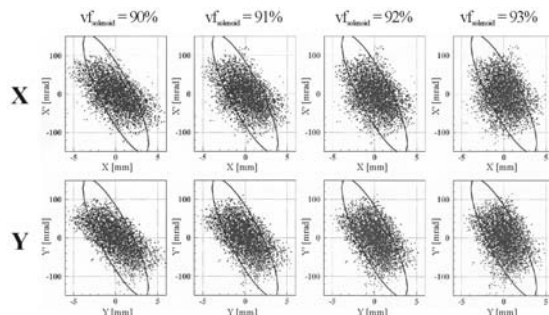

Figure 11: The horizontal (top) and the vertical (bottom) macroparticle distribution at the RFQ entrance for different values of the solenoidal B-field; 100% corresponds to the design value.

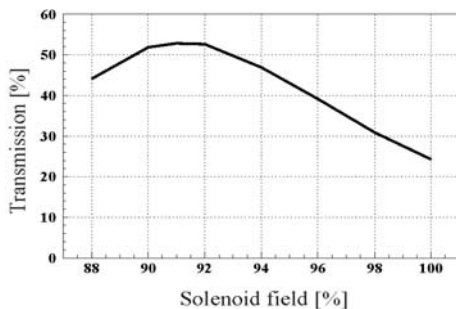

Figure 12: Calculated RFQ transmission as a function of the solenoidal B-field; 100% corresponds to the design value.

A maximum particle transmission (Fig. 12) of about 50% was calculated; the measured one is about 30%.

The matching solenoid is already placed as close as possible to the RFQ. Due to the technical limitations this distance can not be decreased. With recent machine settings the only magnetic field of the solenoid can be optimized for a beam matching to the RFQ. The beam spot and the convergence (95% and 90% level of intensity) in dependence on the magnetic field of the solenoid are presented on Fig. 13. The dashed lines show the beam parameter required by the design of the RFQ Input Radial Matcher. Obviously the necessary beam spot is reached at B-field about of 91% of the design, while the obtained angle is far away from the necessary value.

Generally, the beam can be matched to the RFQ with significantly higher B-field and simultaneously shorter distance from the solenoid to the RFQ. For the HIT-frontend it is not possible due to the technical reasons: field is already high; distance is already as short as possible.

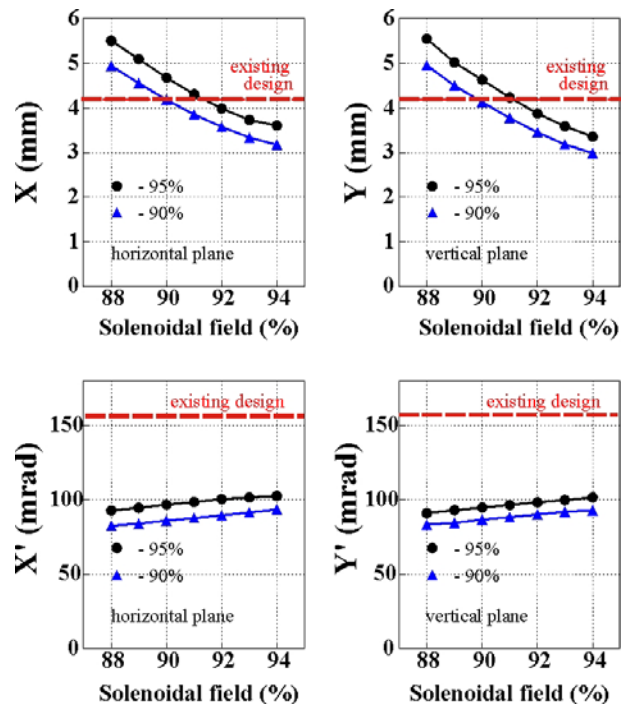

Figure 13: Beam spot and convergence at the RFQ entrance as a function of the solenoidal B-field; dashed lines represent the design requirements.

NEW INPUT RADIAL MATCHER DESIGN

Generally, the particle transmission for the whole front-end system can be significantly increased by changing the matching conditions at the RFQ entrance. It requires minor modifications at the beginning of the RFQ electrodes. Such optimization was proposed for the design of the HSI-RFQ at GSI [10]. An upgrade of the IRM was successfully realized in 2004. The calculated gain in the particle transmission was experimentally verified [11].

To improve the transition of the HIT front-end the IRM was redesigned. Originally the length of the electrodes

with changing aperture was only 8 cells ($8\beta\lambda/2$). The following 8 cells were designed with a small modulation (amplitude less than $\pm 2\mu\text{m}$) not influencing the longitudinal particle motion. The aperture along the new increased IRM (16 cells) follows a special law to provide for improved beam matching (Fig. 14, right), not in accordance with the classical model. The length of the modified IRM is about 4.5 cm. The total length of the electrodes (128 cm) is not changed.

The improved orientation of the acceptance at the RFQ entrance (Fig. 14, left) was calculated using the DYNAMION code and dedicated semi-analytical algorithms. The new IRM design requires for about 50% lower beam convergence ($\alpha = 0.7$, $\beta = 0.058$ mm/mrad) compared to the old design ($\alpha = 1.6$, $\beta = 0.047$ mm/mrad). With the same particle distribution and an optimum solenoidal field a significantly higher transmission was obtained: 75% instead of 50%.

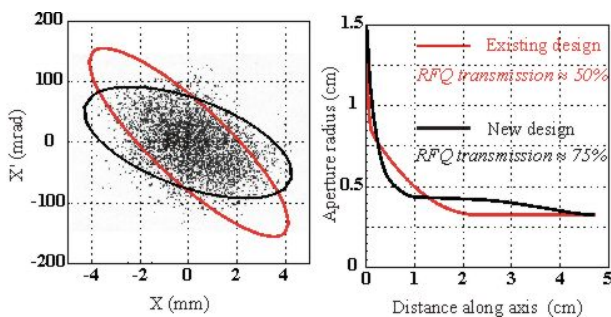

Figure 14: Comparison of the new (black) and the old (rod) design of the IRM: acceptance and calculated particle distribution at the RFQ entrance (left) and the aperture along the IRM-section (right).

The newly fabricated electrodes were installed into the new HIT-RFQ. After a first measurements campaign in Risoe (Denmark) [12] the RFQ was transported to IAP (UNI-Frankfurt, Germany) for further alignment of the electrodes and the rebuncher section. The new design of the IRM is also realized for a second generation RFQ which is recently under commissioning at Marburg Therapy Center (Germany). A substitution of the electrodes for the CNAO-RFQ is already proposed.



Figure 15. Plastic model (GSI construction department) and copper test piece of the RFQ Input Radial Matcher (NTG Neue Technologien GmbH).

CONCLUSION

Advanced beam dynamics simulations by means of the DYNAMION code with C^{4+} design ions demonstrate a low particle transmission of about 50% for the HIT front-end system with recent machine settings. The measured transmission is about 30% only. The most serious reasons are beam mismatch at the RFQ entrance and a significant tank deformation. Minor modification of the RFQ Input Radial Matcher allowed for the increase of calculated transmission up to 75% with the same machine settings.

This measure was realized for the new HIT-RFQ (recently under test stage) and for the RFQ which is now commissioned at Marburg Therapy Center.

REFERENCES

- [1] H. Eickhoff et al., "HICAT - The German Hospital-Based Light Ion Cancer Therapy Project" Proc. EPAC 04, p. 290, 2004.
- [2] M. Maier et al., "Commissioning of the linac for the Heidelberg heavy ion cancer therapy centre (HIT)" PAC 07, Albuquerque, New Mexico, USA, 2007.
- [3] B. Schlitt, "Commissioning and operation of the injector linacs for HIT and CNAO" LINAC 08, Victoria, BC, Canada, pp. 708-712, 2008.
- [4] R. Cee et al., "Intensity upgrade programme for the HIT injector LINAC", EPAC 08, Genoa, Italy, 2008.
- [5] S. Yaramishev et al, "Development of the versatile multi-particle code DYNAMION" Nuclear Inst. and Methods in Physics Research A, Vol 558/1 pp. 90-94, 2005.
- [6] A. Bechtold et al., "Beam dynamics of an integrated RFQ drifttube combination" LINAC 06, Knoxville, Tennessee USA, 2006.
- [7] I. M. Kapchinsky, "Theory of Resonance the linear accelerators" Harwood Academic Pub, 1985
- [8] Balabin A. I. "Numerical field calculation in RFQ structure with special shape of electrodes" Preprint ITEP Nr: 107, Moscow, 1981.
- [9] H. Vormann et al., "Status of the linac components for the Italian hadron therapy centre CNAO" EPAC 08, Genoa, Italy, 2008.
- [10] W. Barth et al., "Upgrade Program of the High Current Heavy Ion UNILAC as an Injector for FAIR" Nuclear Inst. and Methods in Physics Research, A, 577(1), pp.211-214, 2007.
- [11] S. Yaramishev et al., "Upgrade of the high current heavy ion front-end system of the GSI UNILAC" Prob. Atomic Sci. Technol. No 4, pp. 64-66, 2006.
- [12] M. Maier et al. "Linac front-end upgrade at the cancer therapy facility HIT" LINAC 08, Victoria, BC, Canada, pp. 208-210, 2008.