

Fast Bunch Profile Monitoring with THz Spectroscopy of Coherent Radiation at FLASH.

Stephan Wesch^{*,1}, Christopher Behrens¹,
Eugen Hass², Bernhard Schmidt¹

¹ Deutsches Elektronen-Synchrotron, Hamburg
² University of Hamburg

Beam Instrumentation Workshop 2012
Thomas Jefferson National Accelerator Facility

Outline

- ▶ Longitudinal diagnostics @ FLASH
- ▶ Spectrometer design + setup
- ▶ Comparison with TDS
- ▶ Control system implementation



Longitudinal Diagnostic

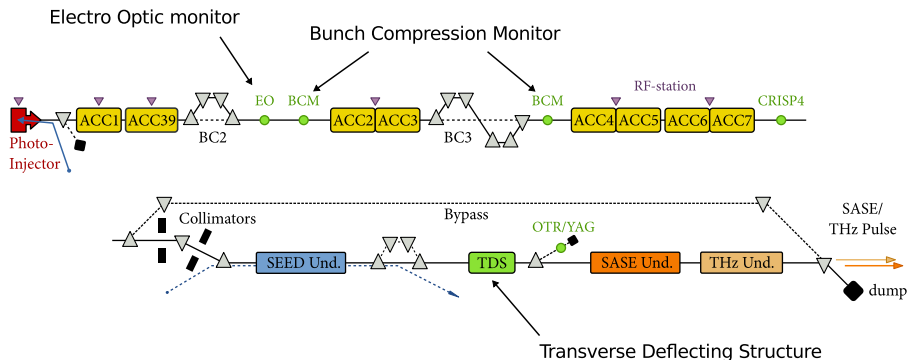

Longitudinal Diagnostic

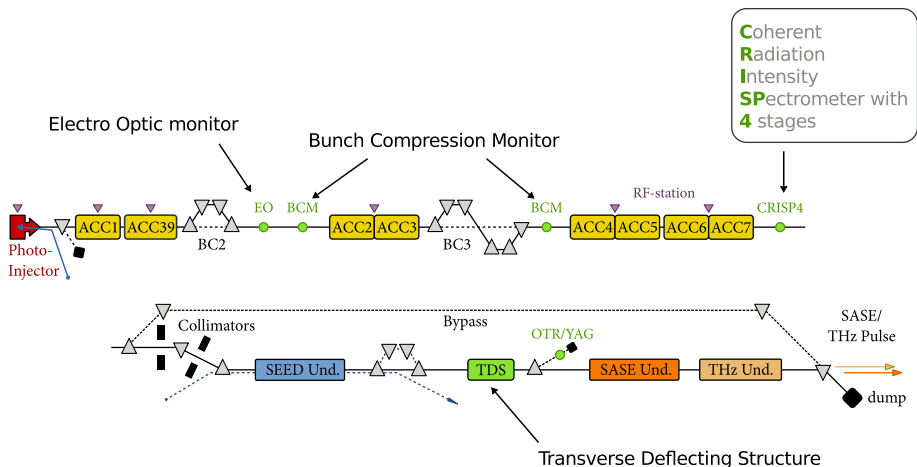

Spectrometer Requirements for FLASH

- ▶ Final bunch length from 10 to 100 μm (30 – 300 fs)
 - **Defines roughly covered wavelength range**
- ▶ Large shot to shot fluctuations (rollover compression 2009)
 - **Single shot measurement**
- ▶ High bunch repetition rate (up to 1 MHz)
 - **Fast readout electronics**
- ▶ Standard bunch length monitor
 - **Robust + easy to handle**

Design of CRISP4: Reflective Blazed Gratings

- ▶ Polarisation \perp groove
- ▶ Blaze angle $\theta_B = 27^\circ$
- ▶ Incident angle $\alpha = 19^\circ$

$$m \frac{\lambda}{d} = \sin(\alpha) + \sin(\beta)$$

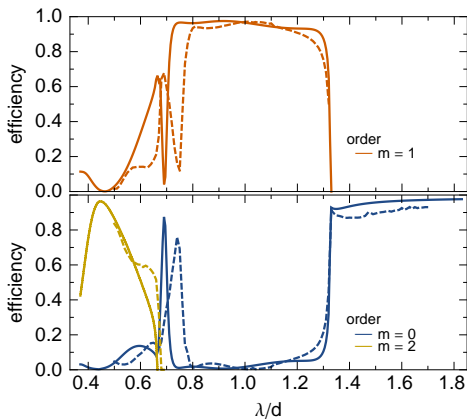
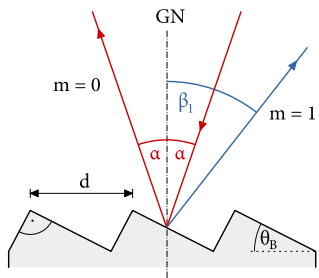

- ▶ **High efficiency** $> 90\%$
- ▶ **Band-pass character** $m = 1$
- ▶ **Low-pass character** $m = 0$

Design of CRISP4: Multi-staged Gratings

Each stage acts as dispersive element
+ filter for next stage

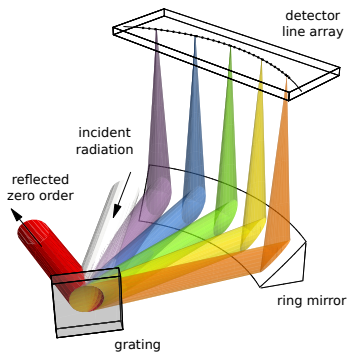
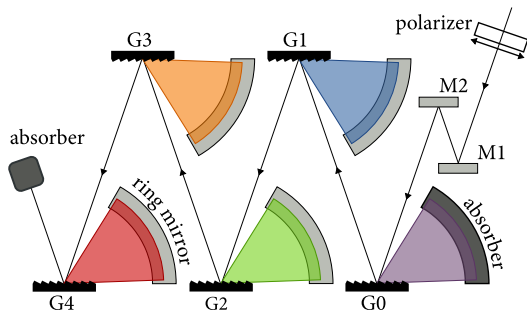

- ▶ Parallel readout
- ▶ 4 Stages cover one order of magnitude in λ

CRISP4: Setup

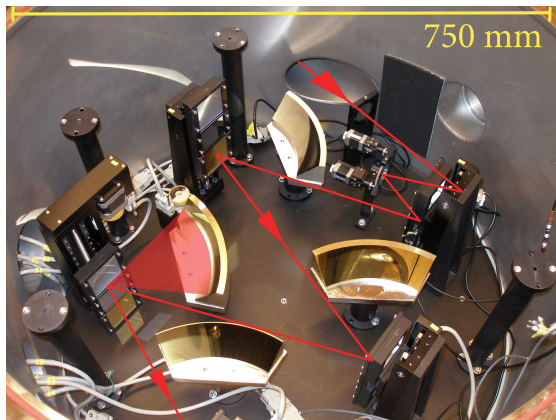

Specifications

- ▶ Engineered version
- ▶ 2 Grating sets
 - $\lambda_{\text{Short}} = 5 - 44 \mu\text{m}$
 - $\lambda_{\text{Long}} = 45 - 435 \mu\text{m}$
- ▶ Mirror set
 - set alignment
- ▶ Ring mirror
 - line focus
- ▶ Inside vacuum vessel
 - avoid IR absorption

CRISP4: Pyroelectric Detectors

- ▶ Broadband
- ▶ Complex spectral sensitivity
- ▶ Calibrated @ FELIX

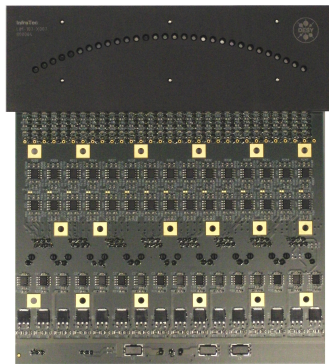
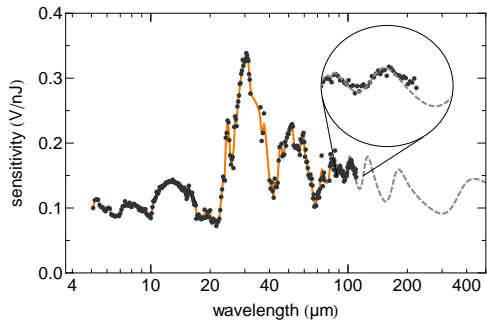

- ▶ Custom-made pyro line detector
- ▶ 120 channels in total
- ▶ Integrated amplifier board
- ▶ Fast readout with 9 MHz sampling

CRISP4: Attachment to CTR beamline

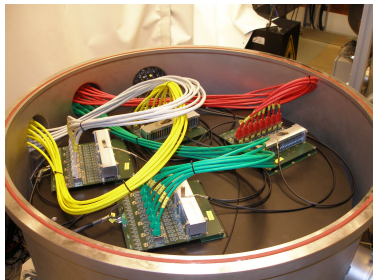

CTR beamline

- ▶ Length 20 m
- ▶ Evacuated
- ▶ Separation from machine vacuum: diamond window
- ▶ High THz transmission

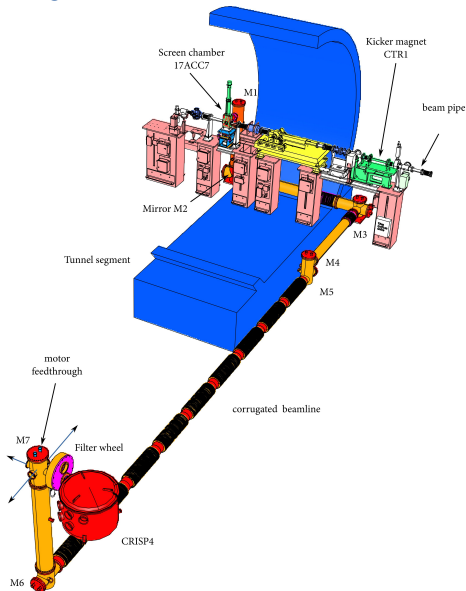

Coherent Radiation Diagnostic: Encoding of Bunch Structure

Coherent intensity density

$$\frac{d^2 U_{\text{coh}}}{d\lambda d\Omega} = \frac{d^2 U_1}{d\lambda d\Omega} N^2 |F_{3D}(\lambda, \Omega)|^2 \quad \text{with} \quad F_{3D}(\vec{k}) = \int_{-\infty}^{\infty} \rho_{3D}(\vec{x}) e^{-i\vec{k} \cdot \vec{x}} d\vec{x}$$

Approximations

- ▶ No longitudinal-transverse coupling

$$\rightarrow F_{3D} \approx F_t F_l \quad \text{or} \quad \rho_{3D} \approx \rho_t \rho_l$$

- ▶ Observation in forward direction

$$\rightarrow F_l(\lambda \cos \theta) \approx F_l(\lambda)$$

Coherent spectral intensity

$$\frac{dU_{\text{coh}}}{d\lambda} \approx \left[\int_{\Omega_{\text{Det}}} \frac{d^2 U_1}{d\lambda d\Omega} F_t(\lambda, \Omega) d\Omega \right] N^2 |F_l(\lambda)|^2 \quad \text{with} \quad F_l(\lambda) = \int_{-\infty}^{\infty} \rho_l(z) e^{-2\pi i z / \lambda} dz$$

- ▶ **Measure absolute spectral intensity** → **get longitudinal form factor**

CRISP4: Determination of the Longitudinal Form Factor

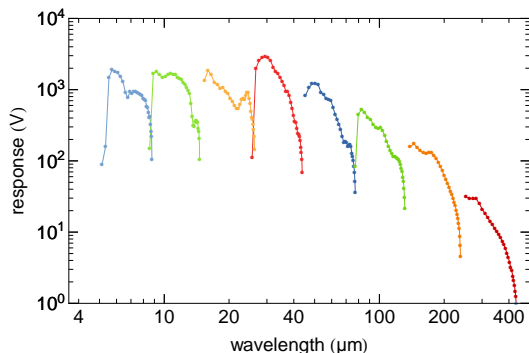

Calibration includes

- ▶ CTR source
- ▶ Transport to detector
- ▶ Grating efficiency
- ▶ Detector sensitivity
- ▶ Electronics

Electron Bunch Parameters

- ▶ $\sigma_l = 0$ ($F_l = 1$)
- ▶ $\sigma_t = 200 \mu\text{m}$
- ▶ $Q = 1 \text{ nC}$

$$|F_l| = \left(\frac{\text{adc signal[V]}}{\text{charge[nC]}^2 \cdot \text{response[V]}} \right)^{1/2}$$

Benchmark: Transverse Deflecting Structure (TDS)

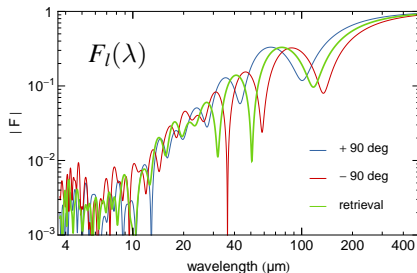
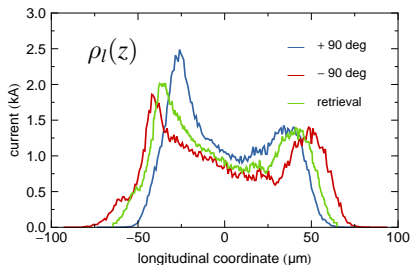
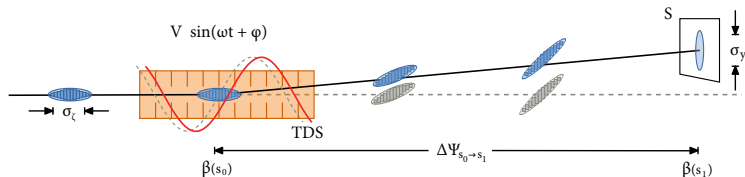

Hidden (y', z) correlation demands two-point “tomography” cf. Hendrik Loos, SLAC

Benchmark: TDS - CRISP4 Comparison

$$\rho_{l,TDS}(z) \xrightarrow{FFT} |F_l(\lambda)|$$

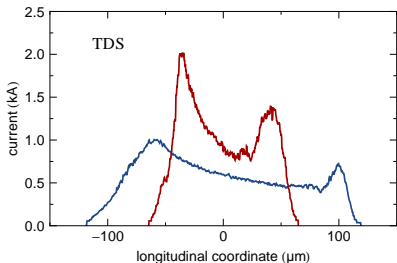

- ▶ Agreement @ long wavelengths
- ▶ CRISP4: More short wavelengths content
 - ▶ Finite resolution
 - ▶ Smoothing due tomography
 - ▶ 60 m in between

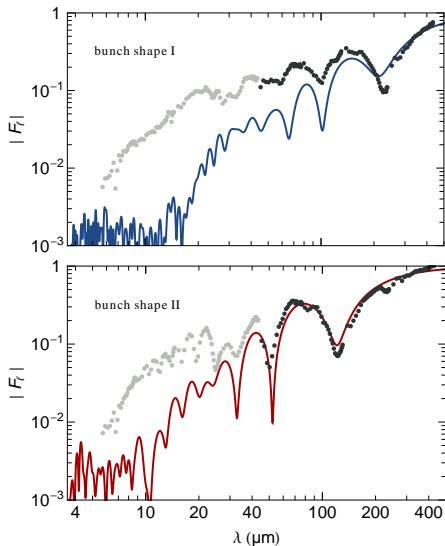

Profile Determination by using Kramers-Kronig-Relation

R. Lai and A. J. Sievers, NIM A **397**, 221-231, 1997,

"On using the coherent far IR radiation radiation produced by a charged-particle bunch to determine its shape"

Complex form factor (ρ_l is real)

$$F_l(\lambda) = \int_{-\infty}^{\infty} \rho_l(z) e^{-2\pi i z/\lambda} dz \quad \text{with} \quad F_l(\lambda) = |F_l(\lambda)| e^{i\Phi(\lambda)}$$

Connection: real \longleftrightarrow **imaginary part** (certain class of ρ_l)

$$\ln F_l(\lambda) = \ln |F_l(\lambda)| + i\Phi(\lambda)$$

Retrieval of minimal phase ($\Phi_{kk} = \Phi_{\min}$)

$$\Phi_{kk}(\lambda) = -\frac{2\lambda}{\pi} \int_0^{\infty} \frac{\ln |F_l(\lambda')| - \ln |F_l(\lambda)|}{\lambda'^2 - \lambda^2} d\lambda'$$

Reconstruction of longitudinal profile

$$\rho_l(z) = -2 \int_0^{\infty} |F_l(\lambda)| \cos \left(\frac{2\pi z}{\lambda} - \Phi_{kk}(\lambda) \right) \frac{1}{\lambda^2} d\lambda$$

Kramers-Kronig-Relation: Test with TDS Profiles

$$\rho_{l,\text{TDS}}(z) \xrightarrow{\text{FFT}} |F_l(\lambda)| \xrightarrow{\text{KK}} \rho_{l,\text{kk}}(z)$$

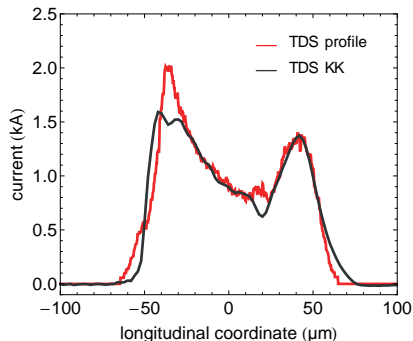
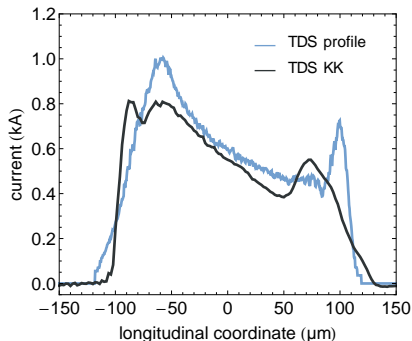

► Reasonable reconstruction, but known deficits:

- Steeper + smoother edges
- Minimal phase Φ_{kk} → “most compact” bunch profile

Profile: TDS - CRISP4 Comparison

- ▶ Long wavelengths extrapolation Fit with $F_I(\lambda) = \exp[-A \lambda^{-2} - B \lambda^{-1}]$
- ▶ Short wavelengths cut at minimal CRISP4 range $F_I(\lambda < 5 \mu\text{m}) = 0$

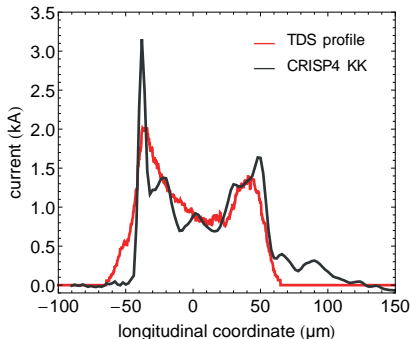
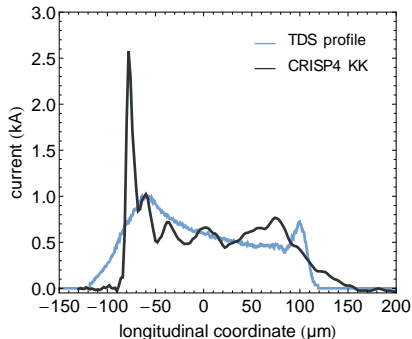

- ▶ Average currents agree
- ▶ Total bunch lengths agree
- ▶ More pronounced trailing spike
 - ▶ Short wavelengths!
 - ▶ Large local energy spread!

Control System Implementation: Online Spectrum Monitor

Kicker

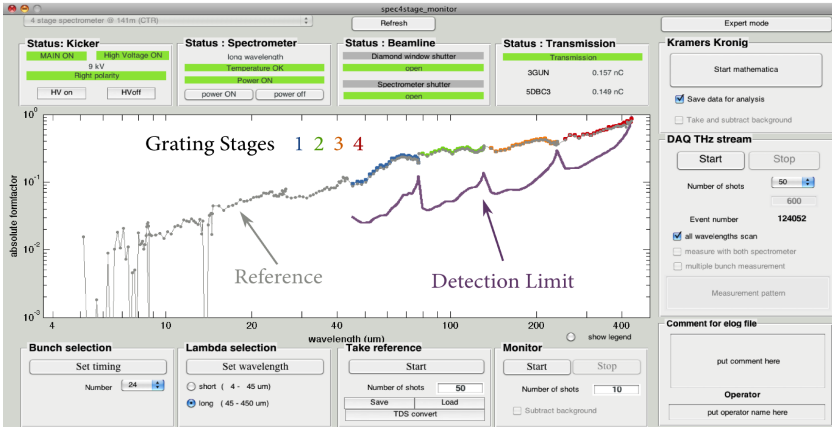

Profile retrieval

DAQ

Bunch number

Wavelength

Examples: Short Pulses

Measured form factor

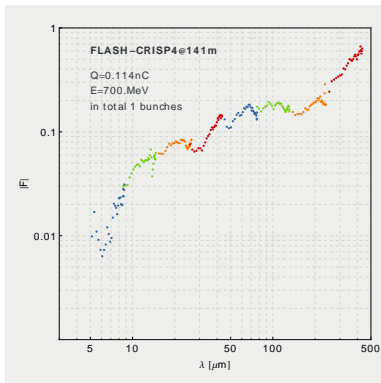

Reconstructed profile

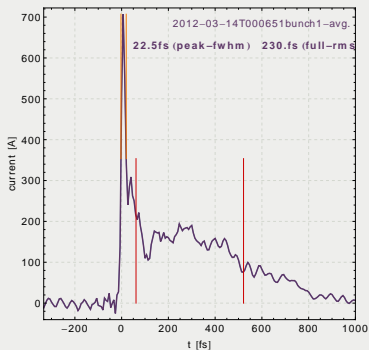

- ▶ $Q = 120 \text{ pC}$
- ▶ $\sigma_z = 10 \text{ fs!}$

Examples: Within Bunch Train / Double Shot

Along bunch train

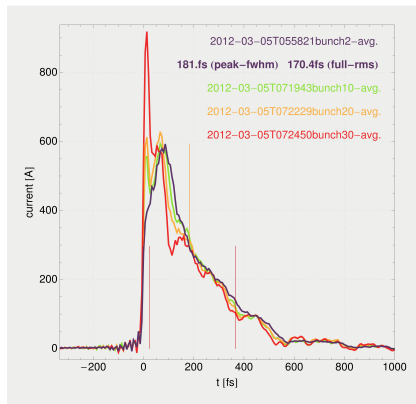

Different shots same bunch number

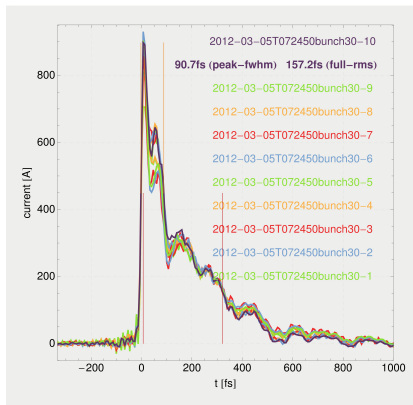

► Possible variation can be detected

► Small shot to shot fluctuations

Summary

- ▶ Development of a broadband CTR THz spectrometer
- ▶ “Double” shot from $\lambda = 5 - 435 \mu\text{m}$
- ▶ Capable down to charge of 100 pC
- ▶ Now routinely used by operators
- ▶ Complementary method to TDS measurements

Thanks to ...

- ▶ Lex van der Meer idea of staging gratings
- ▶ Hossein Delsim-Hashemi proof of principle + Prototype
- ▶ Technicians of FLA Group construction + infrastructure
- ▶ FLASH Team beam time + kicked bunch!

Backup: Wavelength Calibration

