

BPM ELECTRONICS BASED ON COMPENSATED DIODE DETECTORS – RESULTS FROM DEVELOPMENT SYSTEMS

M. Gasior, R. J. Steinhagen, CERN, Geneva, Switzerland
J. Olexa, Slovak University of Technology, Bratislava, Slovakia

Abstract

High resolution beam position monitor (BPM) electronics based on diode peak detectors is being developed for processing signals from button BPMs embedded into future LHC collimators. Its prototypes were measured in a laboratory as well as with beam signals from the collimator BPM installed on the SPS and with LHC BPMs. Results from these measurements are presented and discussed.

INTRODUCTION

The BPM electronics based on compensated diode detectors has been developed at CERN already for some time, with first results reported in 2010 [1] and beam measurements published in 2011 [2]. This contribution focuses on laboratory and beam measurements performed during 2011 with two Diode ORbit (DOR) front-end (FE) prototypes, built as 19" 1U units.

The block diagram of two identical DOR FE channels intended for processing signals from one pair of BPM electrodes is shown in Fig. 1. The beam signal from each BPM electrode is sent over a coaxial cable of typical length in the order of 100 m to the DOR FE, located outside the accelerator tunnel, as it is built with standard components, potentially sensitive to radiation. Close to the BPM may be located a relay RF multiplexer, commuting the BPM electrode signals between the FE channels to remove systematics introduced by the gain and offset errors of the following cables and electronics. As such a calibration technique is a subject in itself, its performance will be reported in a separate publication and the measurements described in this paper were carried without the RF multiplexer.

The first stage of the FE is a constant-impedance 80 MHz low-pass filter, lowering the beam signal to an acceptable level. The filter output is connected to a programmable gain amplifier through an RF transformer, preventing low frequency ground loop currents. The amplifier maintains the signal at the level sufficient to

operate the following compensated diode detector in a linear regime for all beam intensities. The diode detector, the key part of the system, converts short beam pulses into slowly varying signals, low-pass filtered to 10 Hz and finally sent to one channel of a 24-bit ADC, sampling all its 8 channels simultaneously at 11.7 kHz rate. The ADC samples are averaged by a programmable factor and sent from the DOR FE as UDP frames by a built-in microcontroller through an Ethernet link.

LABORATORY MEASUREMENTS

To check long term stability of the DOR prototype, a 10 MHz sinusoidal signal was connected simultaneously to all 4 FE inputs with its amplifiers operating at their maximum gain of 40 dB. The obtained results are presented in Fig. 2, showing the equivalent position drifts projected to a 49 mm aperture of the LHC arc BPMs, together with the internal FE temperature. Channels 1 and 2 were used to simulate beam position measurement in one BPM plane ("position 1-2"), channels 3 and 4 in the second plane ("position 3-4"). It can be seen that the maximal drift of the simulated position during 18 hours is in the order of 1 μm for the FE temperature change of $\approx 2.5^\circ\text{C}$. The corresponding measurement noise as calculated on the last hour of the measurement was below 20 nm_{RMS} .

DOR prototype position errors induced by simulated beam intensity changes and centred beam were estimated similarly to the previous measurement, with a 10 MHz signal connected to all 4 FE inputs, but this time with the amplitude ramped up from zero to the level sufficient to reach the ADC full scale (FS). The obtained results are presented in Fig. 3, showing the beam position projected to the 49 mm stripline BPM aperture for two cases: with and without calibration of the channel gains and offsets. Since all channels had the same input, the output signals of each channel pair could be correlated and obtained coefficients (shown on the plot) used to correct for the channel gain and offset spread. This simple calibration

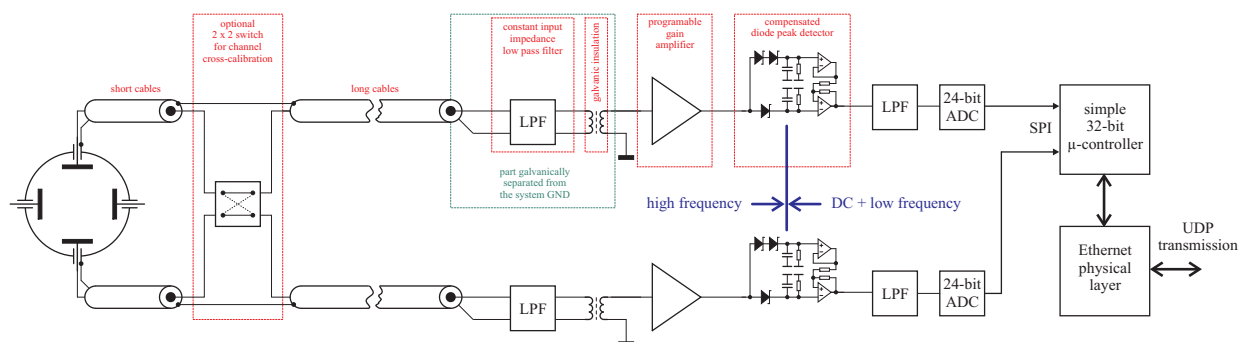

Figure 1: Block diagram of two channels of the Diode ORbit (DOR) measurement system.

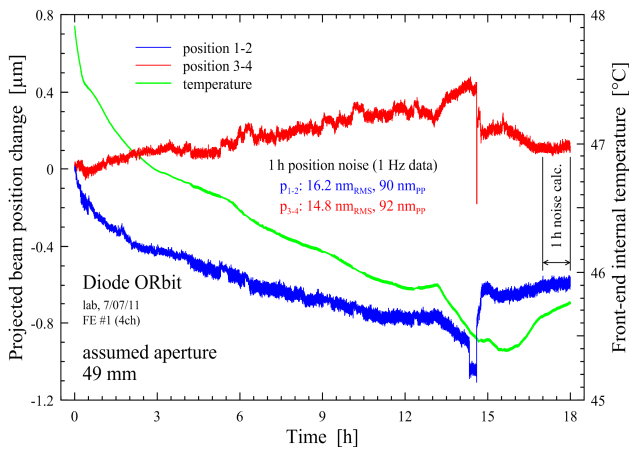

Figure 2: Long-term stability of the DOR FE prototype projected to 49 mm BPM aperture, lab measurement.

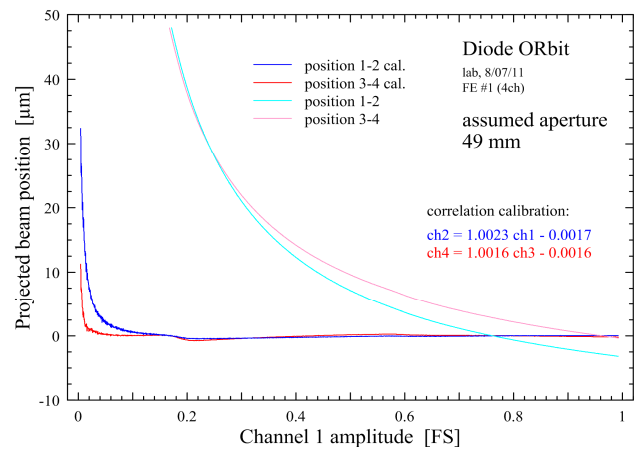

Figure 3: DOR FE linearity error projected to 49 mm aperture with simulated centred beam, lab measurement.

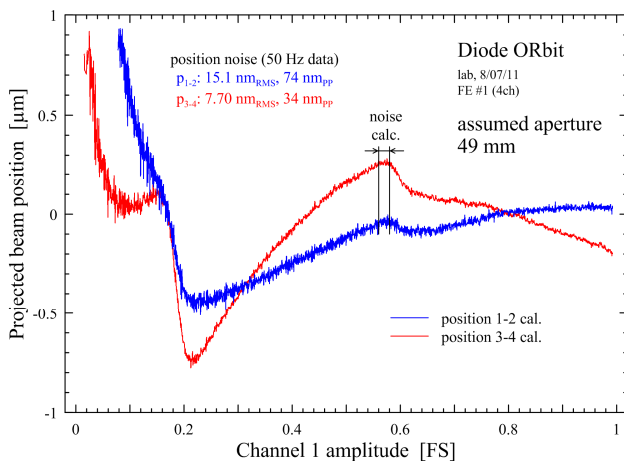

Figure 4: Zoom on the calibrated signals of Fig. 3, lab measurement.

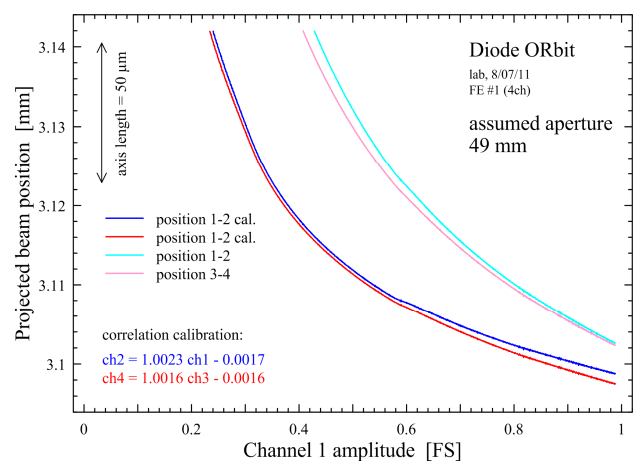

Figure 5: DOR FE linearity error projected to 49 mm aperture with a simulated beam offset, lab measurement.

procedure reduced dramatically the simulated intensity-related position errors, as shown in Fig. 4 with the adequate scaling. For the input signals above 0.3 ADC FS the position errors caused by the simulated intensity changes are below $\approx 0.5 \mu\text{m}$, with the measurement resolution below $\approx 20 \text{ nm}_{\text{RMS}}$ at 50 Hz data rate.

In a similar measurement one signal of each DOR channel pair was attenuated to simulate an off-centred beam. The DOR position errors induced by simulated beam intensity changes in such conditions are shown in Fig. 5. The simulated beam position is about 3 mm and the intensity-related position change reduces below $10 \mu\text{m}$ for signals larger than about 0.6 ADC FS. This effect reveals a remaining non-linearity of the detector compensation scheme, which will be attempted to be improved in the future development.

The DOR FE was used to process signals from the BPM of the LHC collimator prototype [3] tested with the SPS single bunch coasting beam. An example of ADC signals corresponding to four button electrodes ($\varnothing 10 \text{ mm}$) embedded at the ends of each collimator jaw (length $\approx 1.2 \text{ m}$) is shown in Fig. 6 for the time of 1.5 hour. Figure 7 shows the corresponding positions

derived from the upstream and downstream button pair signals, normalised to the button distance, changing from 81 mm for the maximal jaw opening at the measurement beginning to about 52 mm at its end. Note that the button electrodes are retracted by 10 mm with respect to the jaw operational surface. Also normalised jaw tilts are shown, calculated from the signals of the BPMs of each jaw. The performance of the DOR front-end is characterised by the measurements shown in Fig. 8, zooming the positions and tilt changes when one collimator jaw was moved in two $100 \mu\text{m}$ steps, resulting in a $50 \mu\text{m}$ equivalent beam displacement. The DOR resolution is estimated by subtracting the upstream and downstream jaw positions, measured on two button electrode pairs spaced by 108 cm, making the measurement independent of the SPS beam stability. The observed position difference steps in the order of $2 \mu\text{m}$ are likely related to a small asymmetry in the motorisation of each jaw end. The noise of the position difference measurement was estimated to be $140 \text{ nm}_{\text{RMS}}$ for 1 Hz data rate.

The second 8-channel DOR prototype was used to process signals from two stripline BPMs located close to an LHC experiment, where accurate orbit measurement is

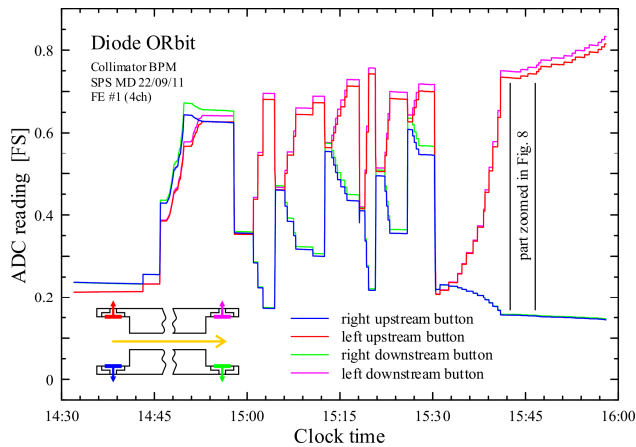

Figure 6: Signals from the collimator BPMs, SPS measurement with a DOR FE prototype.

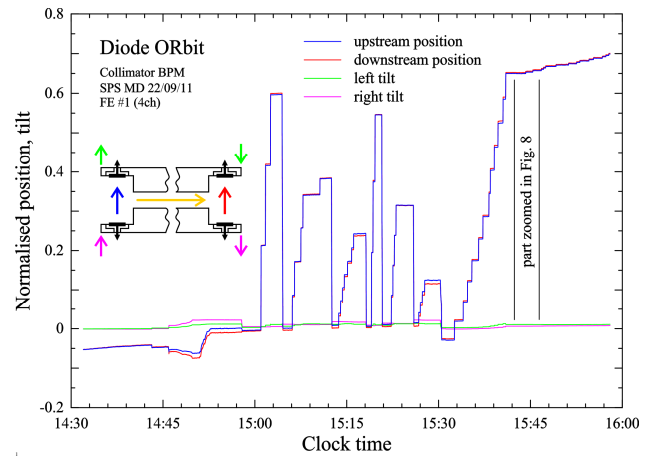

Figure 7: Normalised beam position and tilt calculated from the signals shown in Fig. 7.

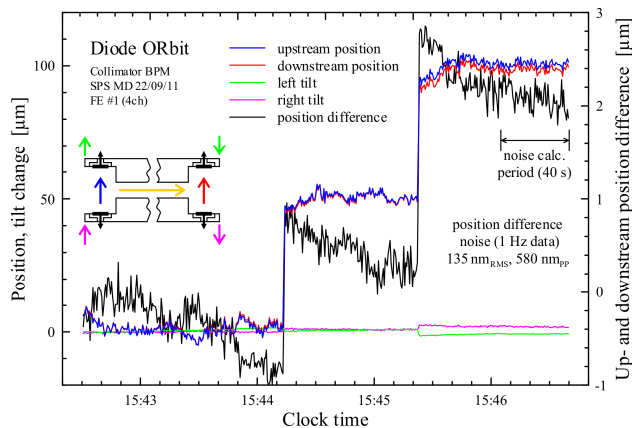

Figure 8: Zoom on a part of the curves in Fig. 7 and the difference of the positions at up- and downstream ports.

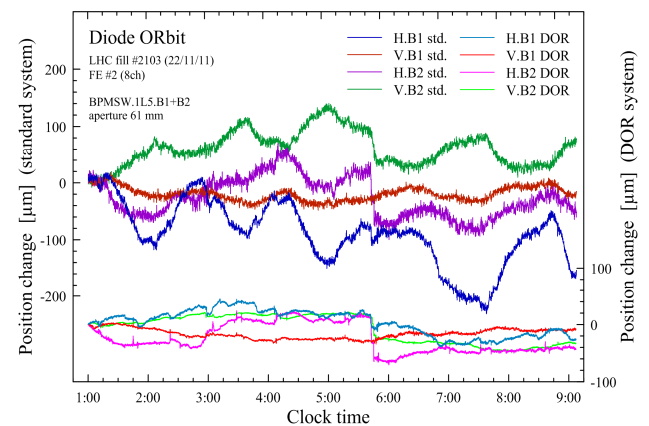

Figure 9: LHC beam position measured by the standard BPM system and the DOR FE prototype.

most critical. The regular LHC BPM signals were split to be processed in parallel by the DOR prototype and the standard LHC BPM electronics. A comparison of beam orbits drift recorded by the two systems during 8 hours of a collision period is shown in Fig. 9. The drifts measured by the DOR system are significantly smaller, as the stability of the standard BPM electronics is affected by its residual sensitivity to temperature variations.

CONCLUSIONS

Two units of BPM electronics prototypes based on compensated diode detectors were measured in the laboratory and with beam signals during 2011, while a more elaborate version of the DOR system was being designed. The presented lab measurements prove a micrometre long term stability of the DOR prototypes and the resolution in the order of $10 \text{ nm}_{\text{RMS}}$. The largest weakness of the technique is probably the residual non-linearity of the detector compensation scheme, which will be addressed in the future development. The measured effect corresponds to about $10 \text{ }\mu\text{m}$ drift for an approximate 3 mm simulated beam position, created by the input signal change of about 40 % of the full dynamic range. This residual non-linearity is only relevant for

substantial beam offsets and therefore is not an issue in case of the future LHC collimators, where the embedded BPMs will be used for positioning the jaws symmetrically around the beam. The DOR FE was used to process signals from the collimator prototype tested with the SPS single bunch costing beam. It was demonstrated that in such conditions the resolution of the DOR prototype is better than $150 \text{ nm}_{\text{RMS}}$, as estimated from the difference of the beam position measured on two button electrode pairs located on the collimator jaw ends.

One 8-channel DOR FE prototype was used to process signals from two LHC stripline BPMs, in parallel to the regular LHC BPM system, allowing comparison of the obtained results. These indicate that the DOR system can potentially be used for improving beam orbit measurements in critical LHC locations.

REFERENCES

- [1] M. Gasiór, R. J. Steinhagen, "High resolution beam orbit measurement (...)", BIW 2010, with the references therein.
- [2] M. Gasiór, J. Olexa, R. J. Steinhagen, "A High Resolution Diode-Based Orbit Measurement System - Prototype Results from the LHC", DIPAC 2011.
- [3] C. Boccard et al., "Embedded Collimator Beam Position Monitors", DIPAC 2011.