



---

## Lessons learned from PEP-II LLRF and Longitudinal Feedback

John D. Fox.

Themis Mastorides, Claudio Rivetta, Dan Van Winkle, Jiajing Xu  
Stanford Linear Accelerator Center

Dmitry Teytelman

Dimtel, Inc.

Work supported by the U.S. Department of Energy under contract #DE-AC02-76SF00515

## PEP-II LLRF and Broadband Feedback

### What Was Expected?

#### Original CDR Goals 1991/1993

- LLRF
- Longitudinal Coupled-Bunch Feedback
- Design and Methodology

### What Happened?

- Commissioning Experience
- Major Upgrades
- Final PEP-II operations, performance

### What wasn't foreseen (via 2 examples)

- LFB - Impact of Noise in processing channel
- LLRF - Impact of Nonlinear Signal Processing

### Important Lessons Learned -Summary

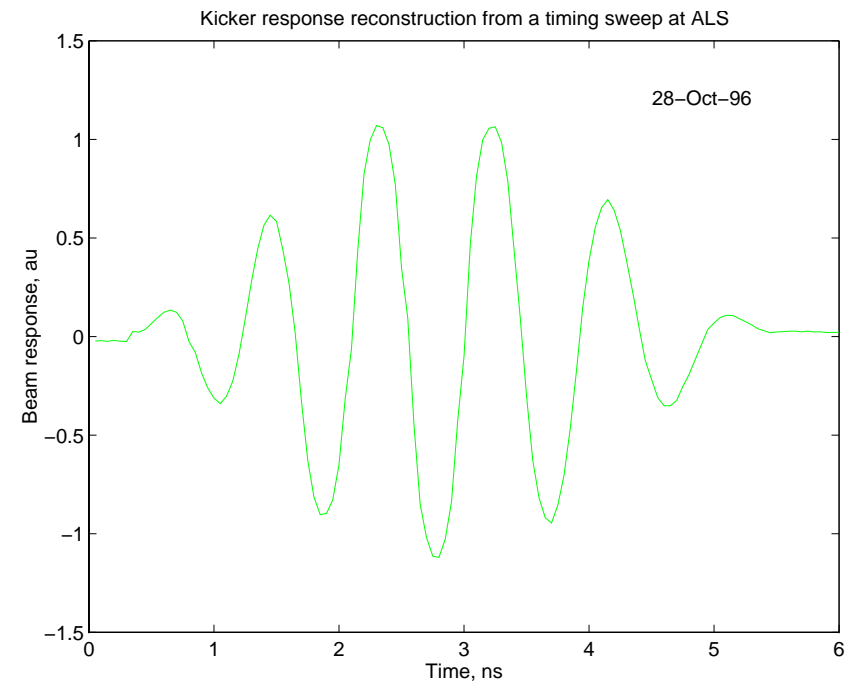

## PEP-II

Two rings of 2.2 km circumference. CDR 1991, updated 1993

- Goal of factory e+e- collider machine L 3E33
- e- HER 1.5A (0.75/1A 1991)
- e+ LER 2.14 A (2.14 A 1991)

### RF concerns

- High Beam Loading
- Impedance of cavity fundamental, detuning - low-mode coupled bunch instabilities

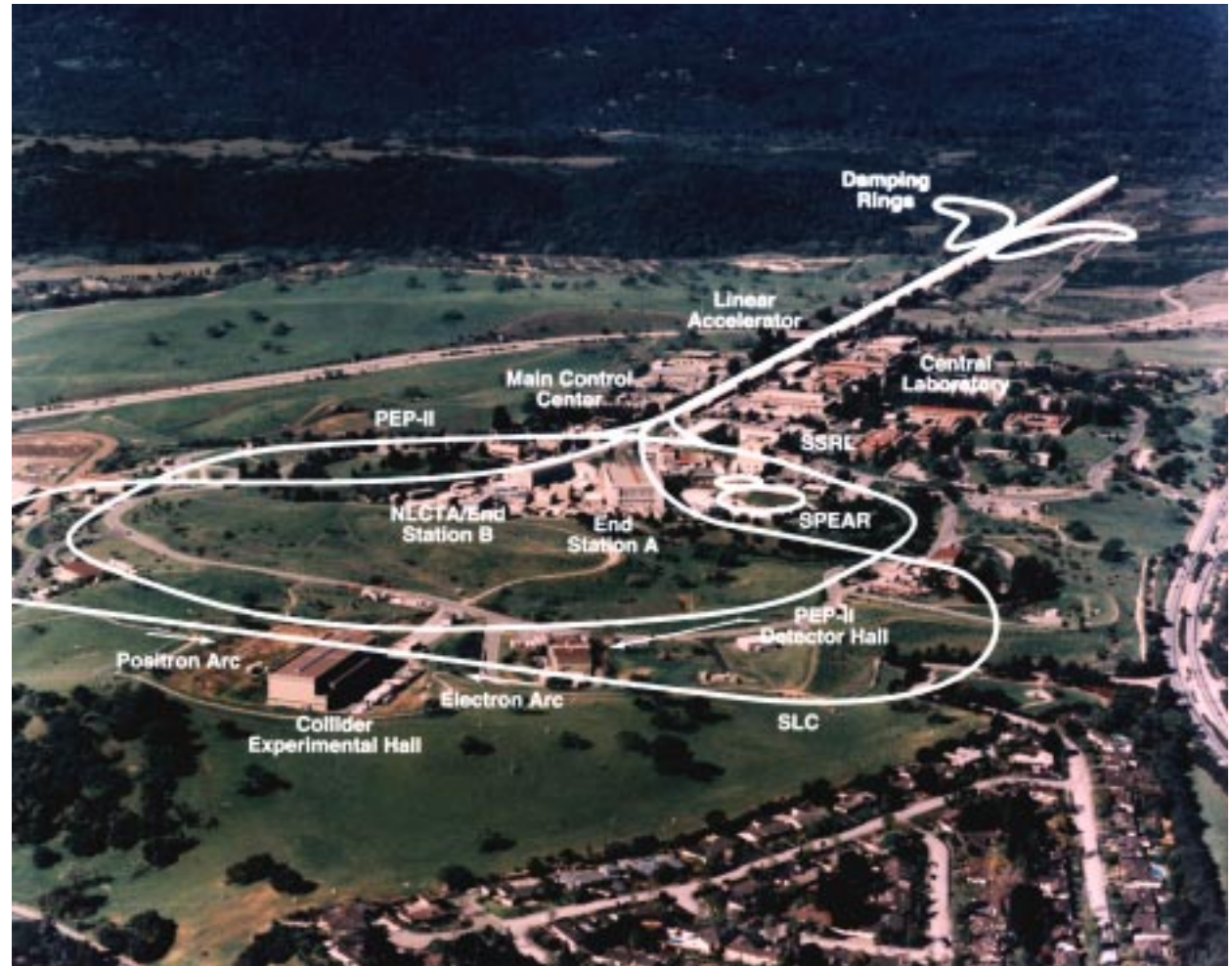

- Reliability -extensive R&D effort in Vacuum, Feedback and RF systems

**Instability Concerns** - operation well beyond stability thresholds in three planes

- HOM Impedances of cavities - HOM driven coupled-bunch instabilities
- HOM Dampers - Still the need for coupled-bunch fast feedback (238 MHz sampling rate)



## Where we started, Where we finished

Year/run	LER stations	LER cavities	HER stations	HER cavities	I HER	I LER	L
1998	2	4	4(+1 parked)	16(+4 parked)	0.6A	1.0A	1.2E33
Run 1	2	4	5	20	0.9	1.5	3.0E33
Run 2	3	6	5	20	1.0	1.7	4.4E33
Run 3	3	6	6	22	1.1	1.9	6.3E33
Run 4	3	6	8	26	1.5	2.5	9.0E33
Run 5a	4	8	9	26	1.7	3.0	1.0E34
Run 5b	4	8	9	26	1.9	2.9	1.2E34
Run 6	4	8	11	28	1.9	3.0	1.2E34
Run 7	4	8	11	28	2.1A	3.2A	1.2E34

HER reconfigured 4 cavity -> two cavity station in Run 3, subsequently added 2 cavity stations  
The operating configuration, gap voltages, tunes, etc. were constantly changing

HER current - 2x design LER Current - 1.8x design Luminosity 4X design

LOM Growth rates HER 1.2 ms<sup>-1</sup> LER 3.0 ms<sup>-1</sup> (design - simulation was damped!)

HOM growth rates HER 3x design LER growth rates 0.45 ms<sup>-1</sup> (5.6x design)

The PEP-II collider holds the record for stored charge in a storage ring (3.213 A at 3 GeV).

Were we successful in the feedback and LLRF areas because it was easy and we overdesigned/  
overestimated things?

## PEP-II low-level RF feedback loops: Topology

**Tuner loops** - standard tuning for minimum reflected power

**Klystron operating point support**

- **Ripple loop** adjusts a complex modulator to maintain constant gain and phase shift through the klystron/modulator system.
- **Klystron saturation loops** maintain constant saturation headroom

**Direct feedback loop (analog)**

- Causes the station to follow the RF reference adding regulation of the cavity voltage
- Extends the beam-loading Robinson stability limit
- Lowers the effective fundamental impedance seen by the beam

**Comb filter (digital)**

- Adds narrow gain peaks at synchrotron sidebands to further reduce the residual impedance

**Gap feedback loop (digital)**

- Removes revolution harmonics from the feedback error signal to avoid saturating the klystron on gap synchronous phase transients

**Longitudinal feedback** uses RF as low-frequency “woofer” kicker for modes +/- 10

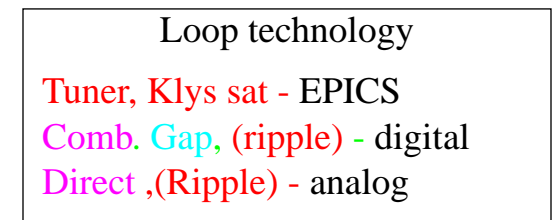
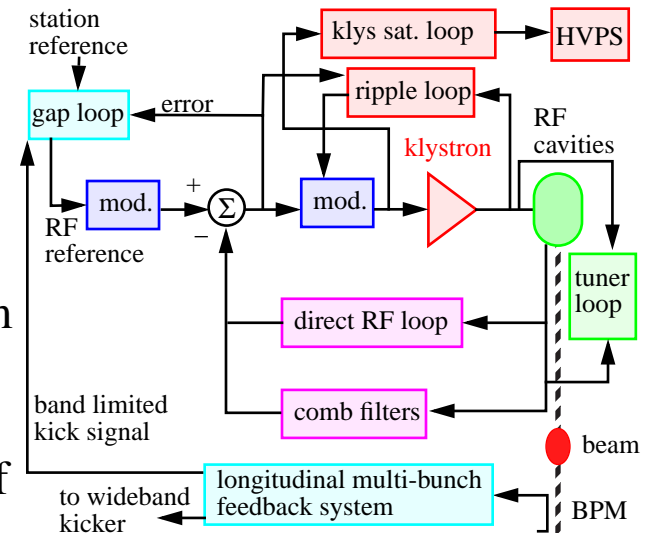

## How was required LLRF performance estimated?

LLRF -Origin and design/modelling F. Pedersen, Stuart Craig (Chalk River), Rich Tighe (SLAC)

- Linear frequency domain models
- Concerns about non-linear klystron, impact on impedance control

LLRF station model, beam model - nonlinear time domain simulations (Tighe, Rivetta, Mastorides)

- Macro-bunch structure, low-mode dynamics with Non-Linear Klystron
- 1994 model - No criteria for stability, robustness beyond trajectories in ms time windows

Design proceeded based on initial simulations. Little criteria for Noise, Dynamic range issues, I&Q mismatches, other technical imperfections

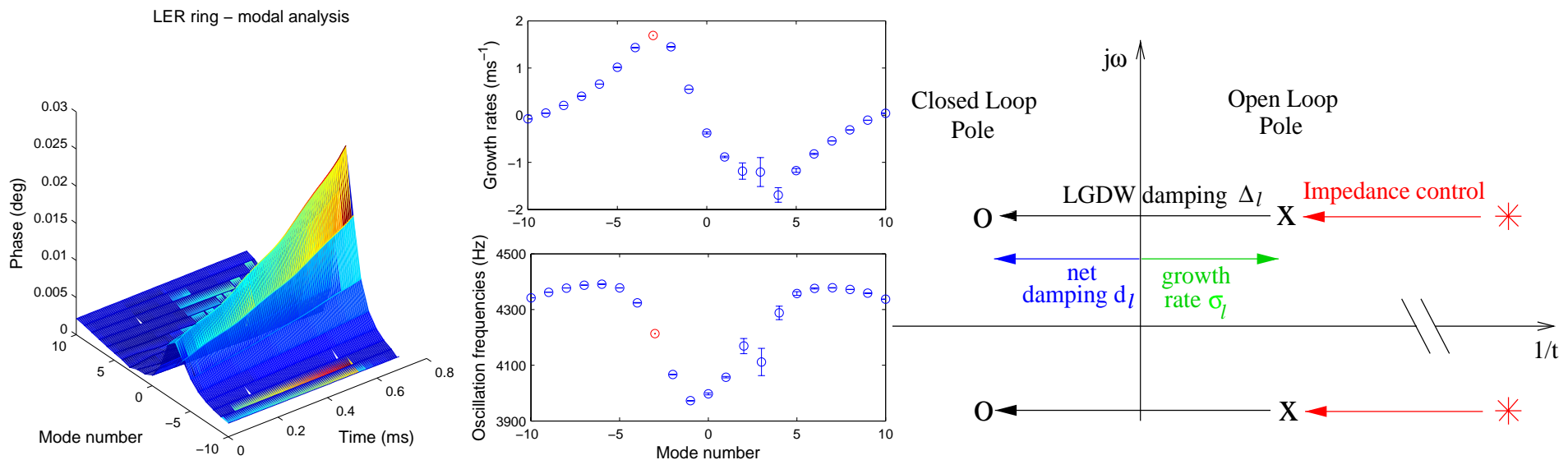

## PEP-II RF Station, LLRF

Each Station

- 1.2 MW 476 MHz Klystron
- VXI-based LLRF electronics
- 2 or 4 RF cavities, with HOM loads
- HV power supply, Interlocks, etc.

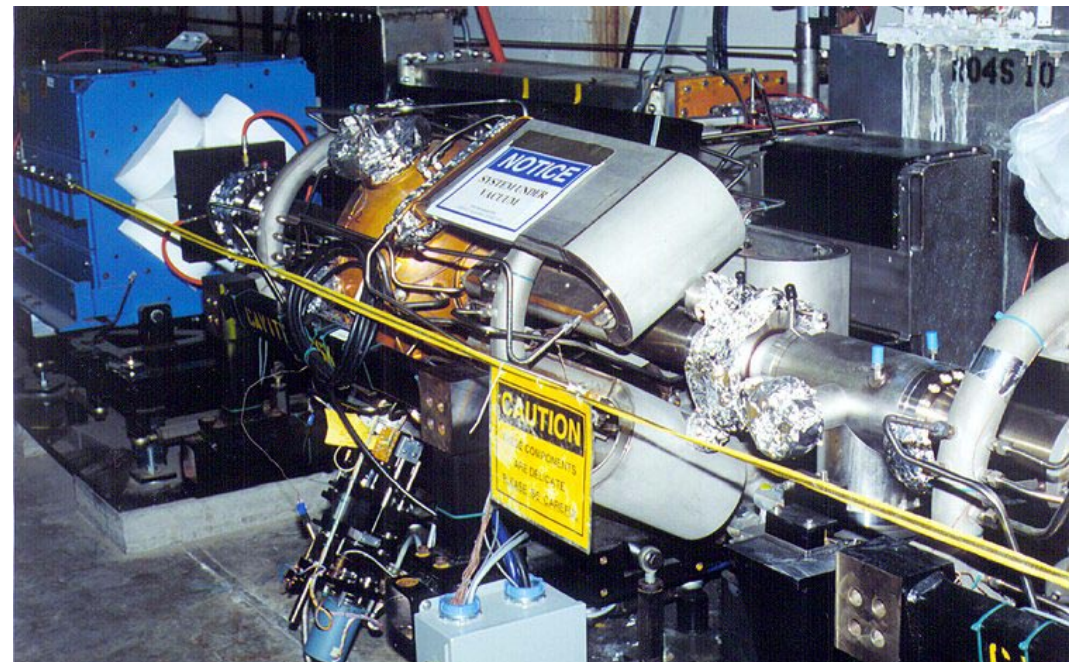
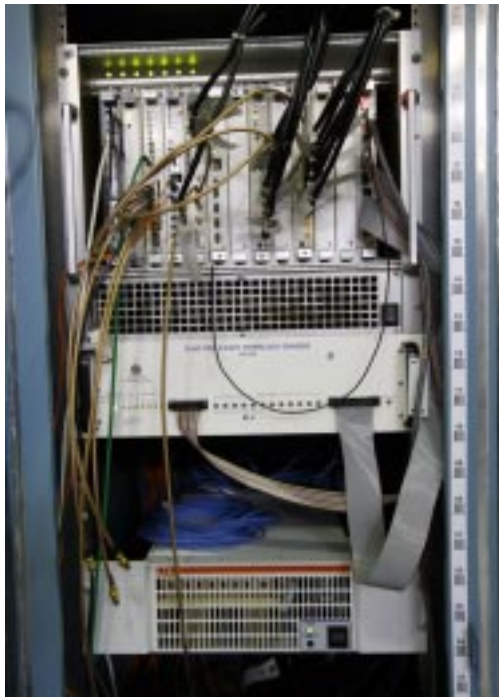

## LFB Systems Design

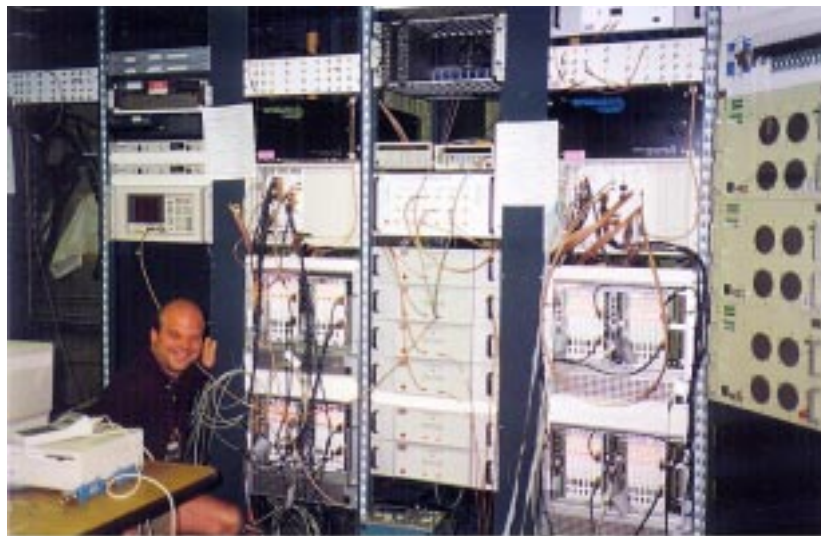

AY\_003

HER and LER Electronics

10-4-87

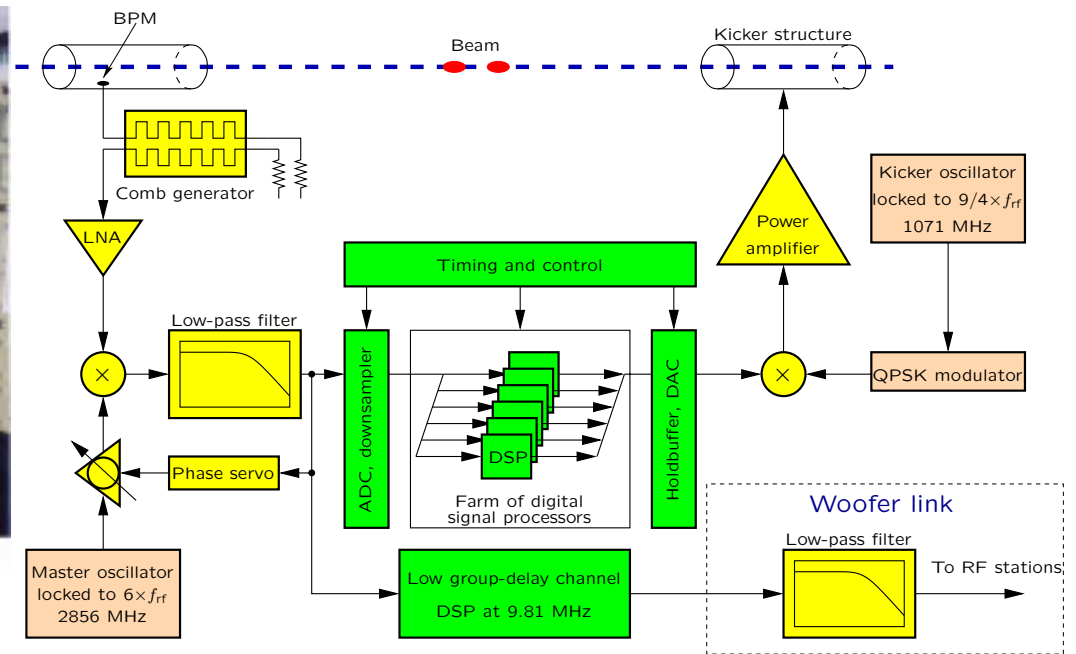

A DSP based flexible, programmable system (can run arbitrary FIR or IIR Filters)

Developed for PEP-II, ALS, DAΦNE (later BESSY-II, PLS and SPEAR). Multi-crate VXI/VME

Detection at  $6 \times F_{RF}$ , correction at  $9/4$  RF (options  $11/4$ ,  $13/4$ )

Scalable VME processing array, up to  $3.2 \cdot 10^9$  MAC/sec.

Sampling, A/D and D/A at 500 MHz (238 MHz PEP-II)

Downsampling to reduce computational load (match processing rate to synchrotron oscillation frequency). Original “woofer” taken at DSP farm D/A wideband output.



## How was required LFB performance estimated?

Linear Growth Rates, Gain and Time-domain Simulation (tracking, cavity HOM estimates, with downsampled FIR filter)

Thresholds, Growth Rates - from cavity HOM measurements/estimates

Beam tests - 1 bunch (SPEAR), ALS 4 processor “Quick Prototype”

Resolution of front end modelled and lab-tested (noise kept small for high DSP gain)

Required kicker power - estimated from injection error (amp expense, minimize installed power)

Dynamics estimates from simulation. Filter completely programmable

Beam-LLRF Simulations predict stable Low-mode behavior - LER issue at ultimate currents

Insurance policy - design in a low-mode “Woofler” channel

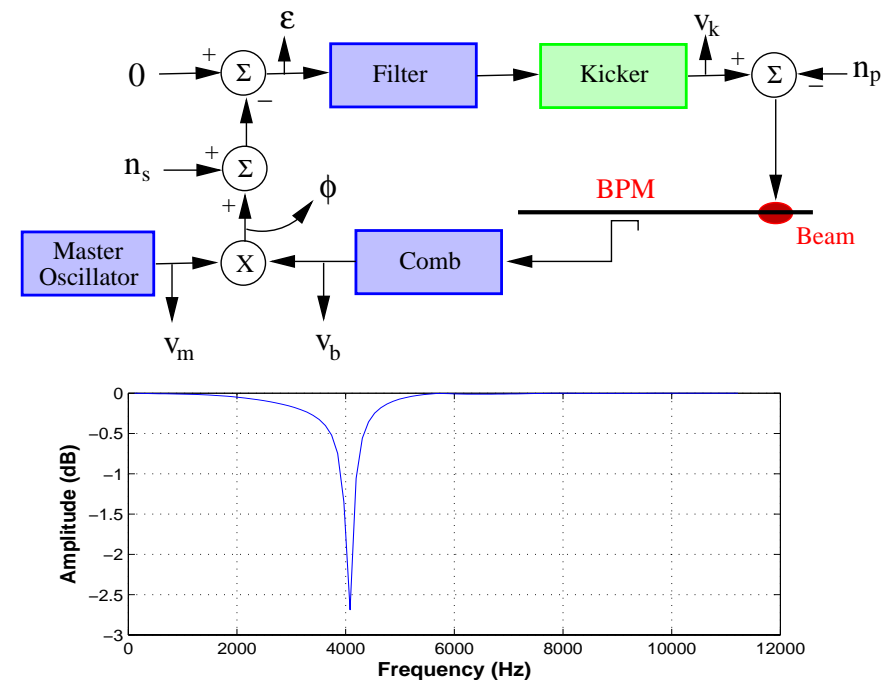
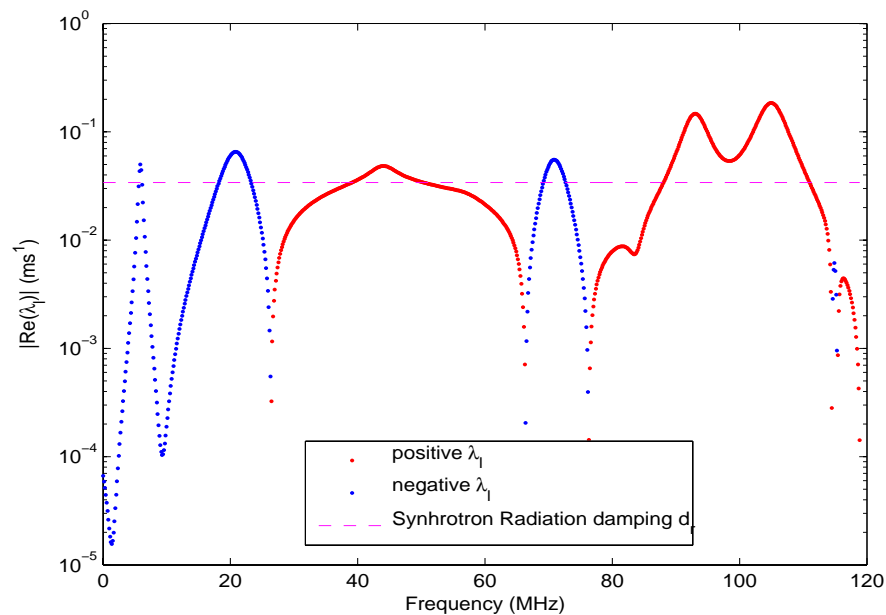



---

## Features Anticipated and Implemented

### LFB

programmable 80 processor DSP reconfigurable array

500 MS/sec. A/D, D/A, Downsampler - table driven 2 ns bucket spacing

Grow-damp dynamics measurements (via dual-port memory, codes)

monitoring functions (Signal MUX, RMS detectors front and back-end)

Woofers output

### LLRF

Software controlled broadband (direct - analog) and comb (IIR digital) loops

Software based low frequency digital regulators via EPICS

Built-in network analyzer (via time domain excitation, response functions)

Fault files

Woofers input

The days of NIM Modules with Pots - are over. Software intensive systems, with VxWorks. GUI, etc.



## Commissioning Experience LFB

ALS - extensive experience with the “quick prototype” made commissioning fast

developed control filters, timing/synchronization methods

VXI system commissioned at ALS 1994

PEP-II (1998)

HOM Thresholds - consistent with cavity HOM measurements - damping rates per simulation

Thresholds - cavity fundamental driven low modes 300 mA (Simulation had them damped!)

Beam has RF power supply noise (very different from ALS)

operational issues -

Woofers required for low mode control

coordination with operations on synchronous phase, timing LFB

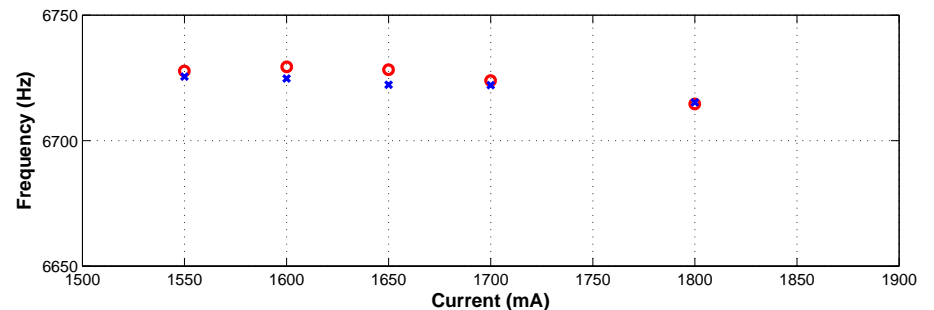
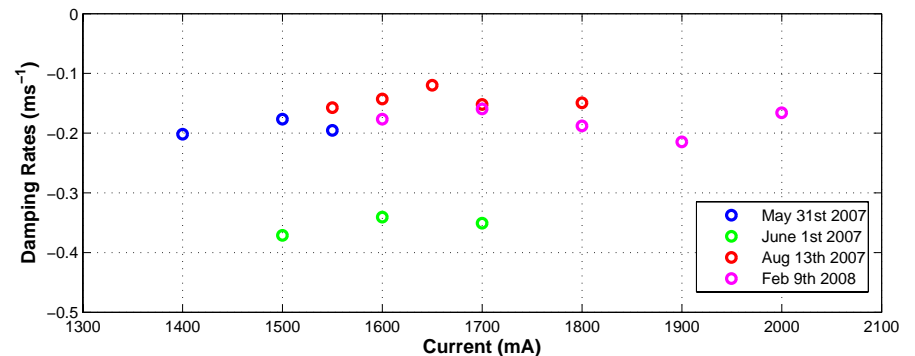
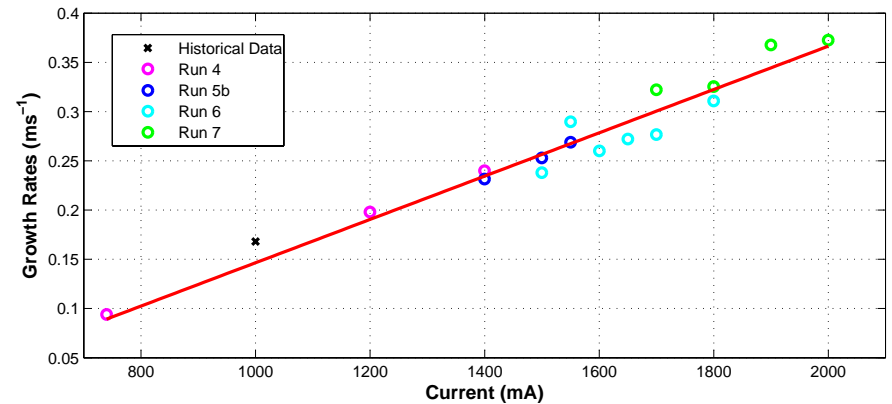

## Unexpected Impact of “noise” in Receiver

**Unanticipated** - amount of “noise” on beam from RF systems (unlike ALS and SPEAR Experience)

Many sources, predominantly klystron HVPS, LLRF processing, phase distribution noise

Impact of driven motion vs. HOM instability

Quantizing noise in A/D, Rcvr noise insignificant

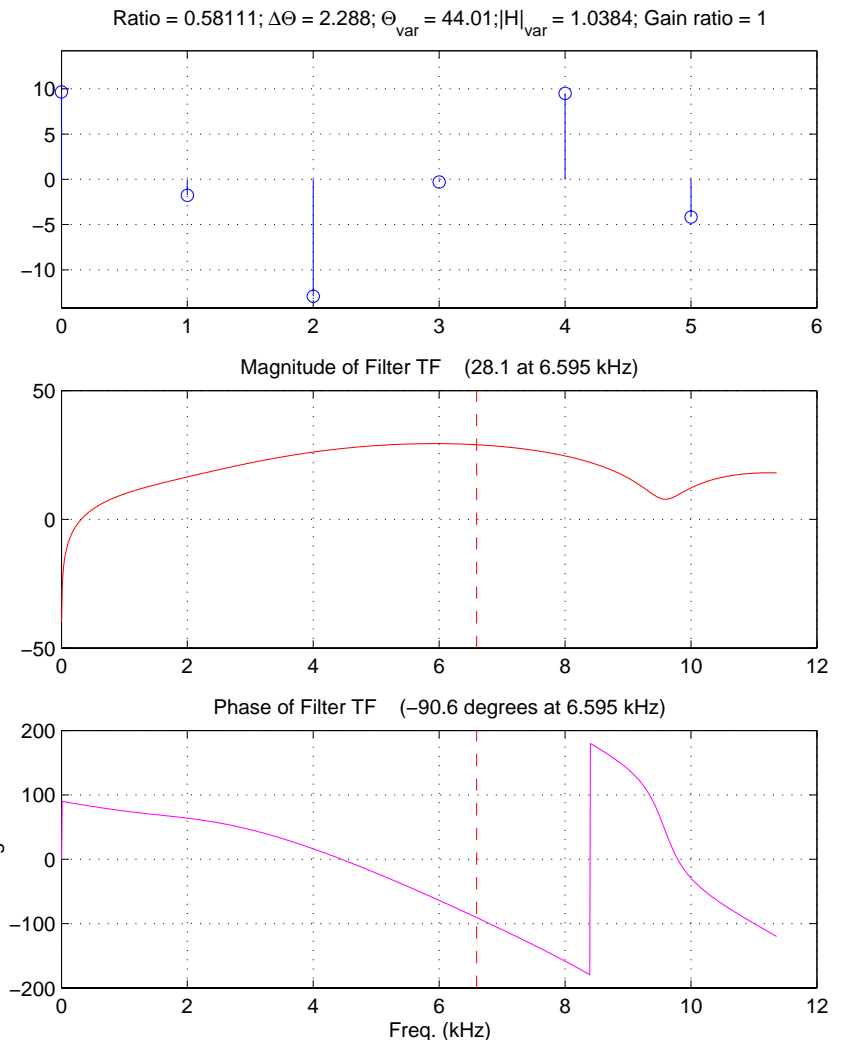
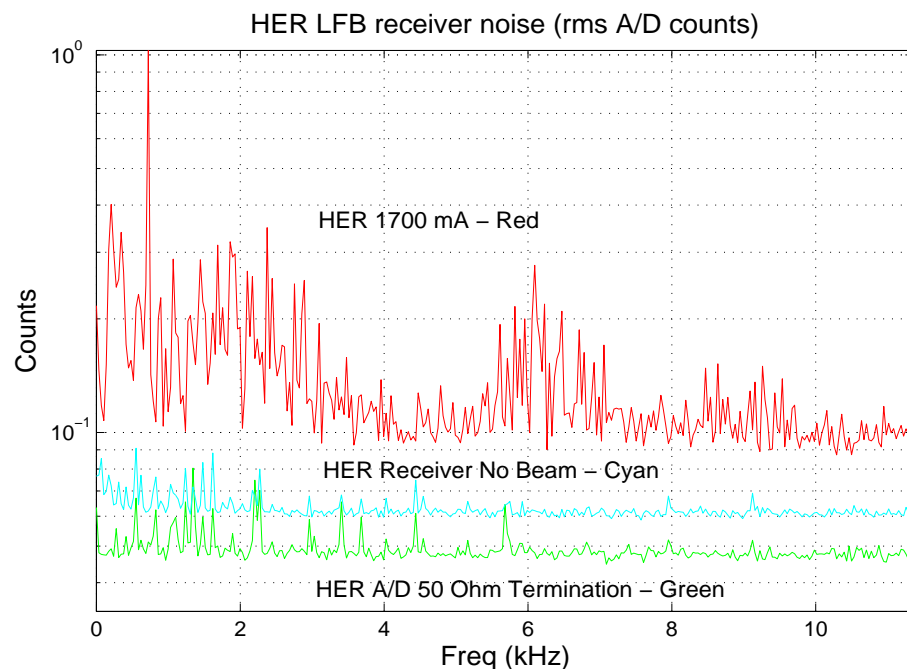

## Low-Frequency Noise leads to saturation and runaway HOM control

At 1900 mA - 2100 mA in HER, unexpected transient saturation effects, loss of control

Very hard to diagnose, not a steady state situation, infrequent transient effects

magnitude of 720 Hz constantly changing with RF system configurations, operating points, active stations, maintenance etc.

solutions via better 720 Hz control in LLRF and woofer ( more kicker amp power would help,too)

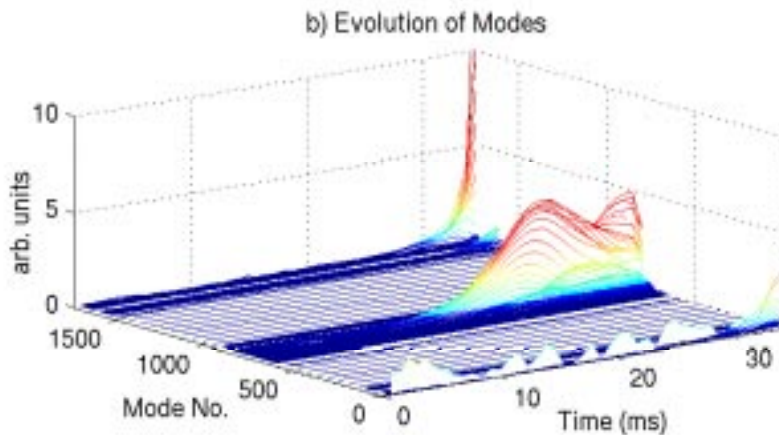
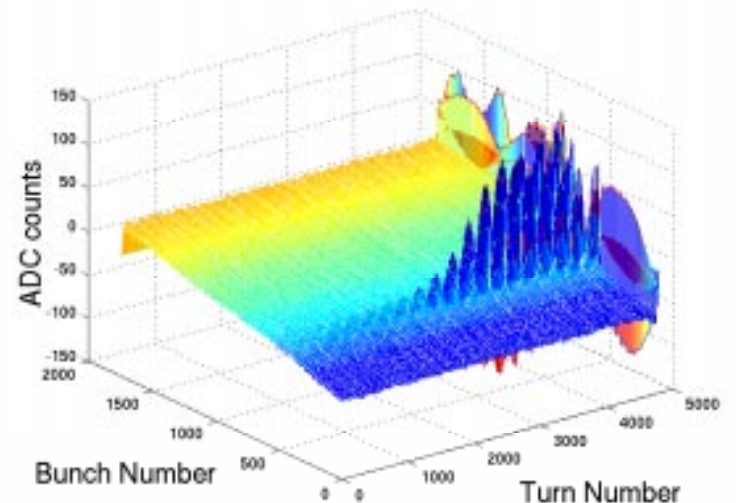
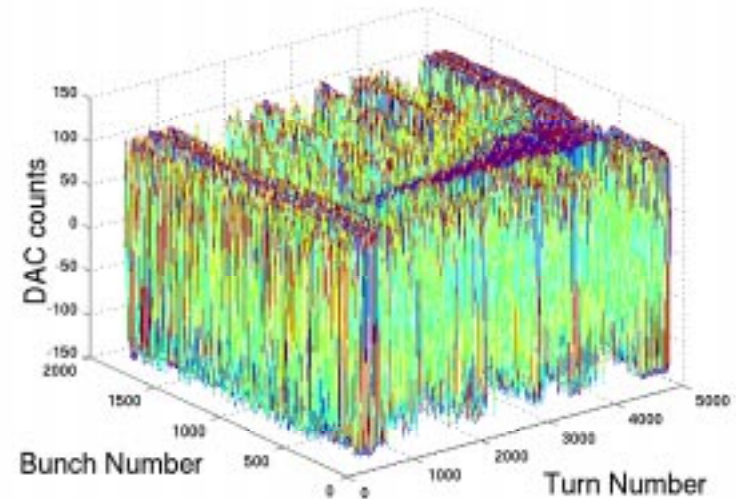

## Commissioning Experience LLRF

Issues with configurations of direct and comb loops -stations oscillating  
 Spurious signals in RF output, klystron oscillations  
 Initial **configuration method** - network analyzer no beam, **gain/phase margins**  
**Instabilities** (Station and/or Beam) at current  
 manual **tweaking** of the direct and comb loops  
 trade-off of **station stability vs. beam stability** - **low mode growth rates much faster than anticipated**

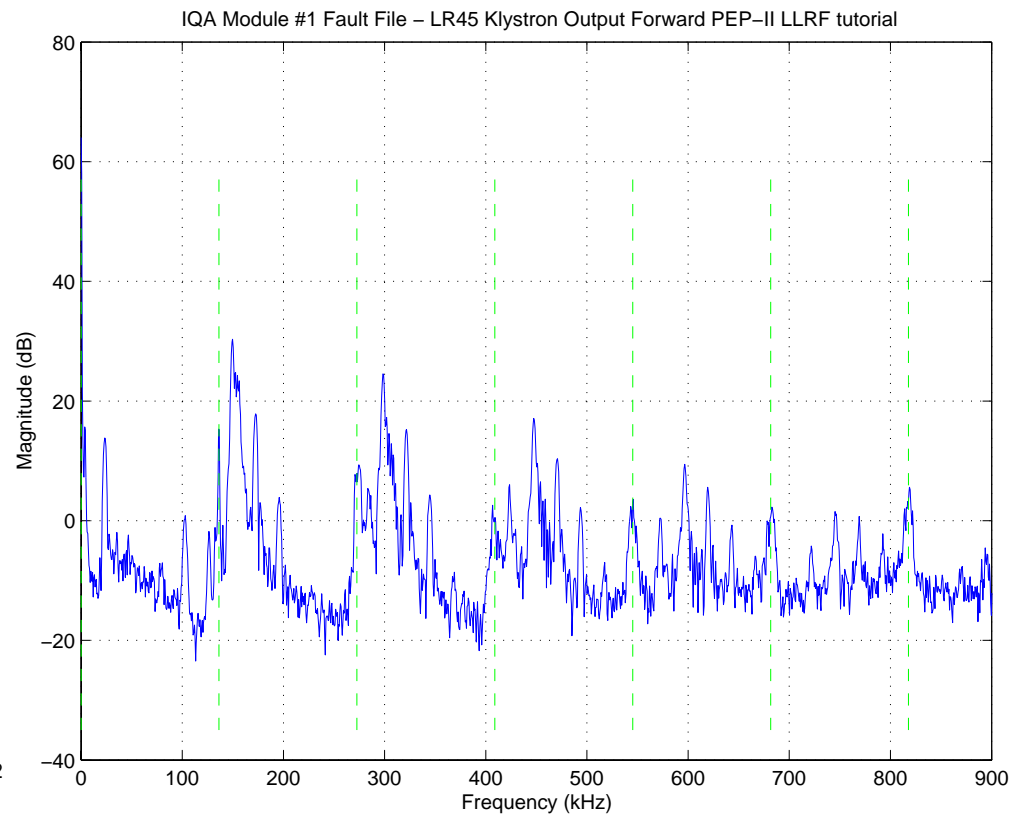
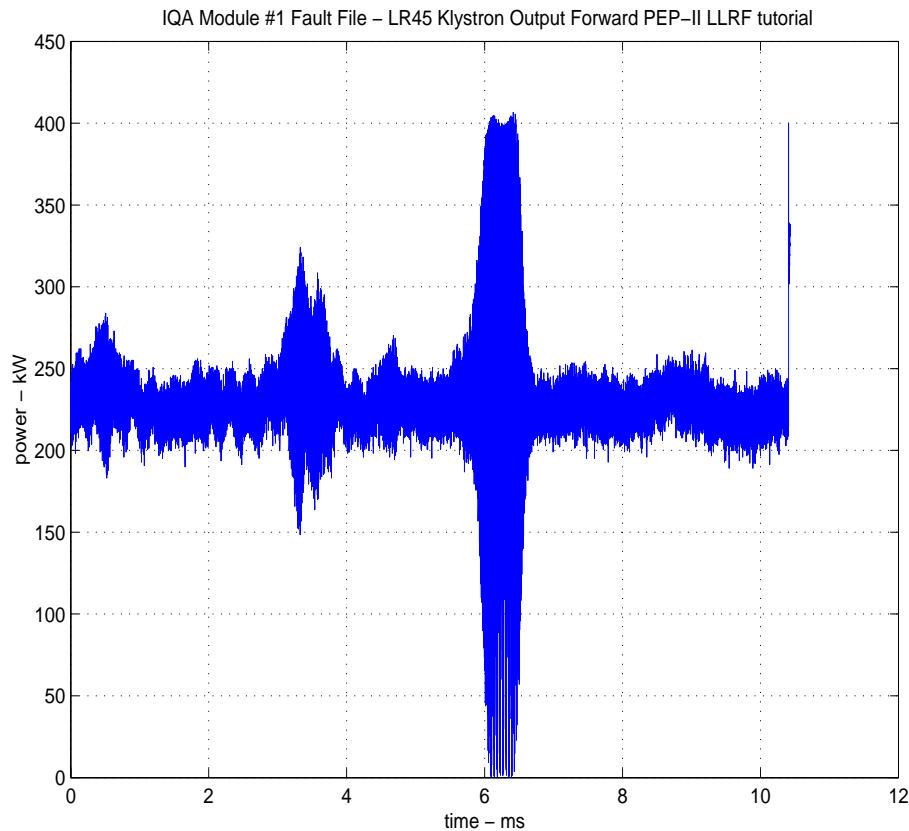

## Major Developments/upgrades - LLRF

**Model based configuration** - reconfigure loops at current. (Dynamics changes with current)

**Fault file methodology**, weekly reports and analysis- understand origins of operational problems

**Low Group delay Woofer** - necessary above 1500 mA (HER), 2A (LER). Rapid low-mode growth

Klystron **linearizer** - effort to address fast low-mode growth rates - but not with expected result

Extensive re-investment in LLRF-Beam **simulation models**. Led to improved **Driver Amplifier**- addresses limits of impedance control, allows comb rotation, more optimal station configurations

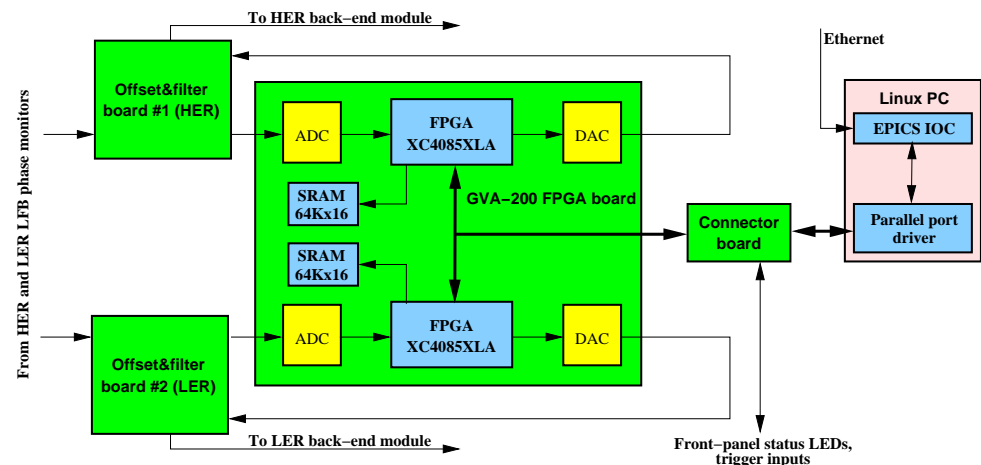
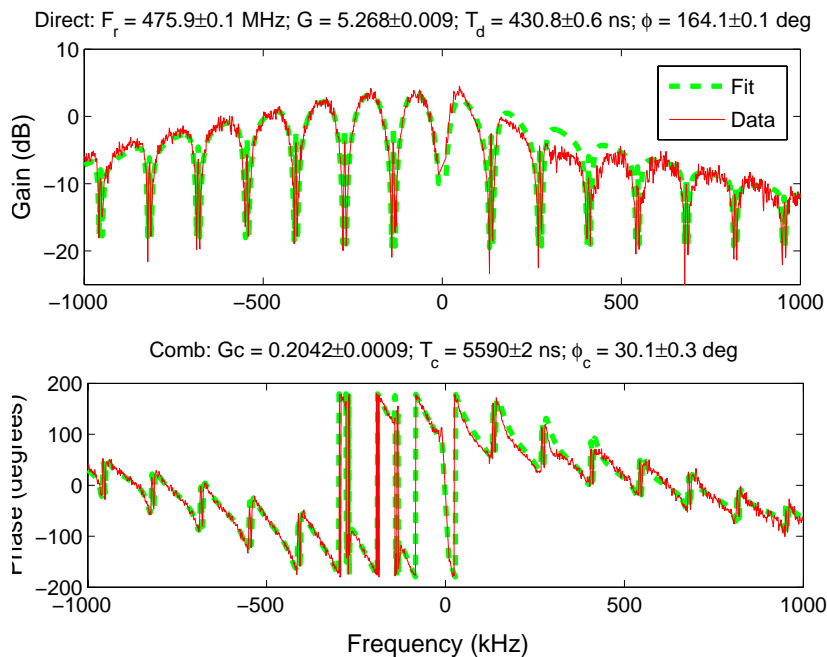



# Understanding the impact of non-linear processing

LLRF Signals - Dynamic range 90 dB!

Non-linear behavior in loop - imperfections

Klystron - obviously non-linear

We missed - medium power amplifier

very significant impact- SS vs. LS gain

Image frequency generation

Not realized for 7 years - understood via model

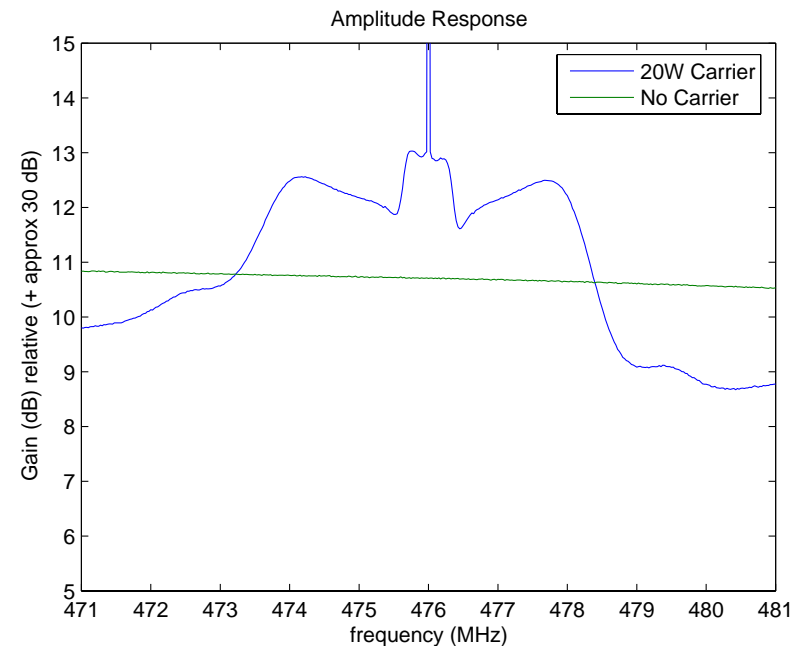
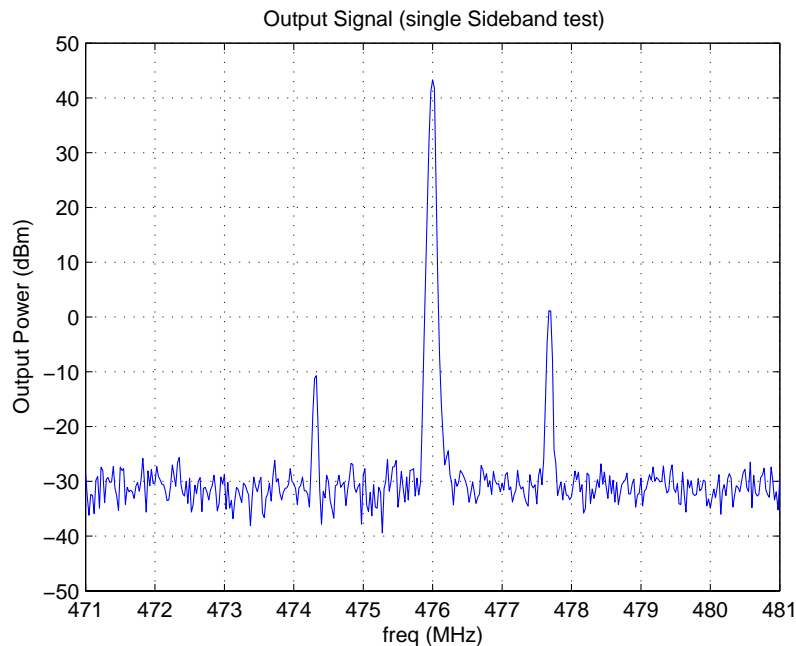
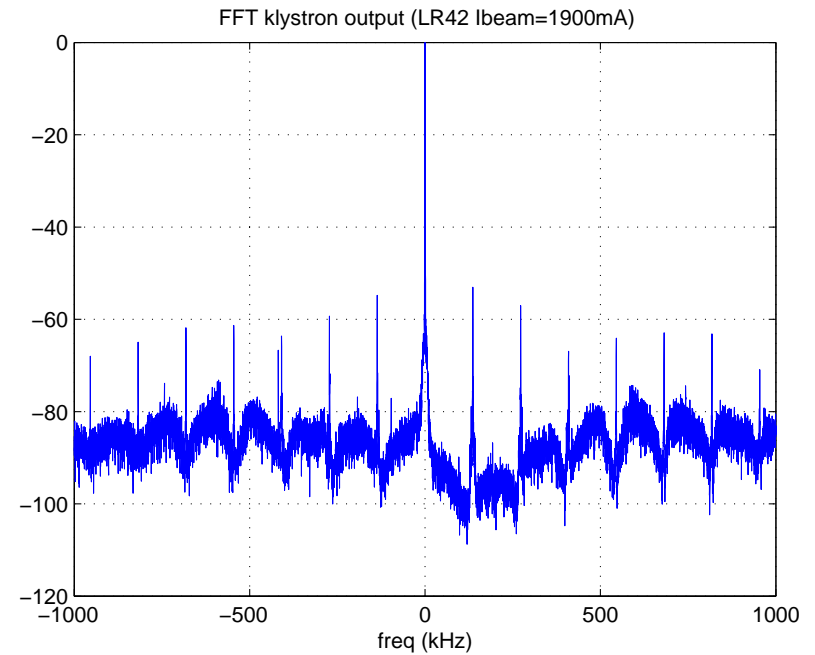



## Final PEP-II Run April 2008

LER LLRF and LOM control limit at 3100 mA without comb rotation, new LLRF amplifier

Replacing Driver Amp, use of “comb rotation” provided 30% improvement in impedance control

Run 5B - old amps, original LLRF config

Run 6/7 - new amps, comb rotation

This was possible, with

- New Modelling
- New control technique
- Careful operating point selection

Many Accelerator issues (e.g. bunch length, heating, optics, choice of gap voltage, etc.)

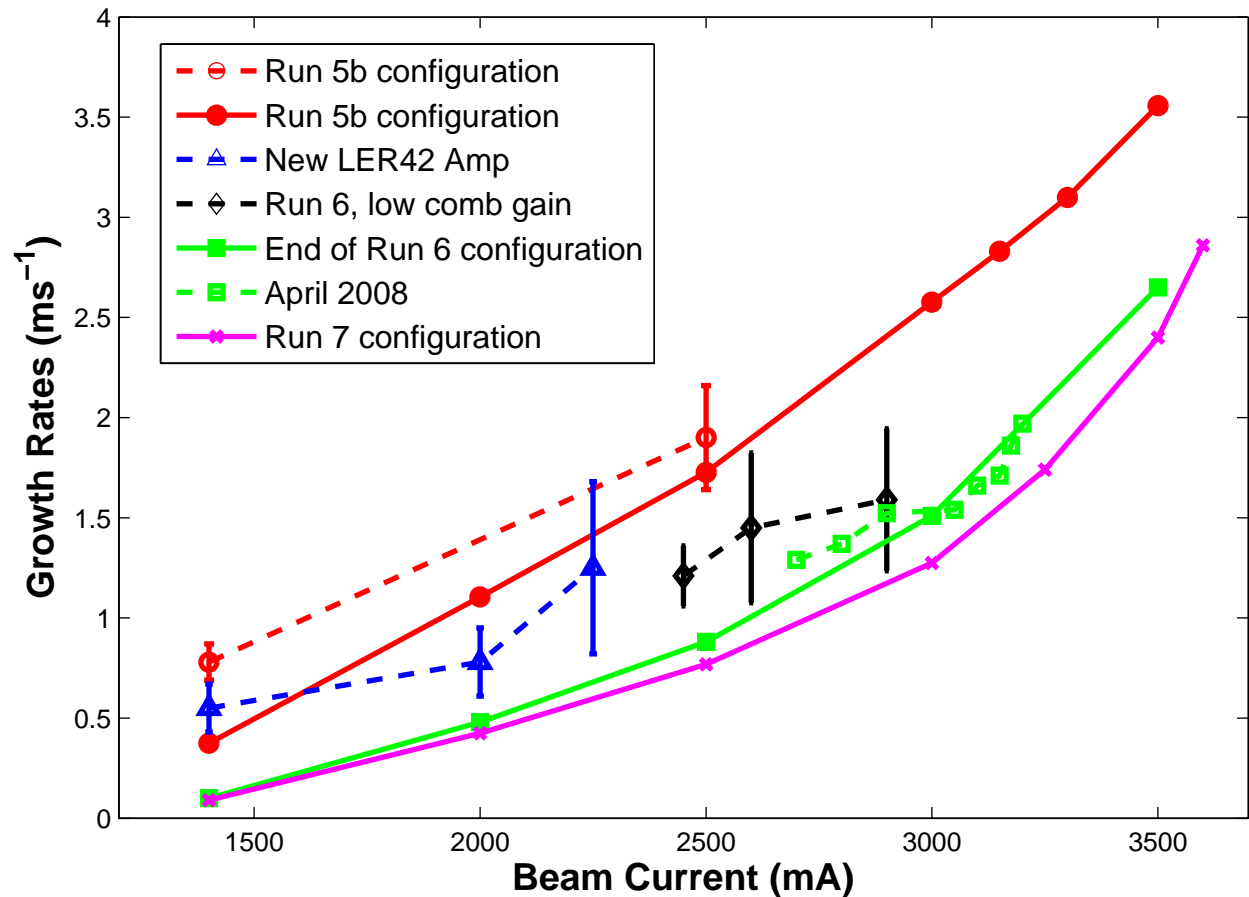

## Lessons Learned

LLRF Modelling - key to understanding non-linear effects

- Non-linear klystron was less significant than drive amplifier

Without models - impossible to sort out effects, see if things were worse than they should be

Models - prediction of limits, identification of nonlinear amp, new control techniques (comb rotation)

This took years, but was invaluable

Fault Files - so much information

PEP-II Experience - needed a full-time RF expert just to understand complexities of faults

who is the customer for this information?

LFB - transient domain measurements key to understanding dynamics

Unanticipated - saturation limit from RF system

Flexibility of DSP architecture key to unexpected applications

New Accelerator Diagnostics developed

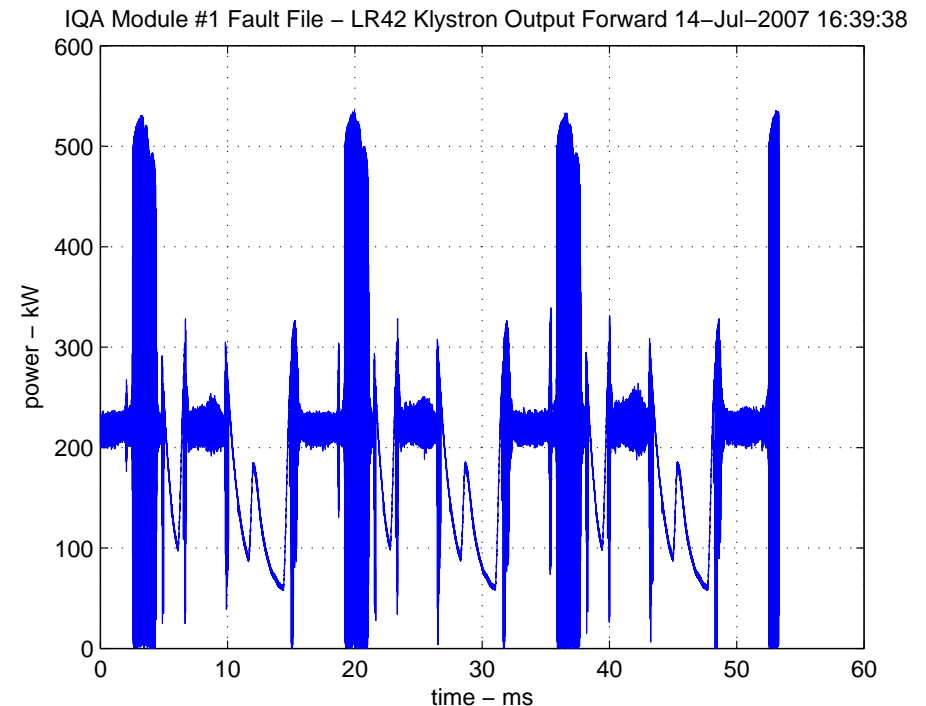

## What wasn't foreseen -more lessons

**LFB** - thermal problems with beam induced power in kickers

- kW power levels -SC/DIN/EIA connectors?
- Cable fires (several systems)

**RF** -

operational task - management of so many stations

- Individual station dynamics- unique station to station
- Individually configured stations

Impact of **non-linear Klystron/Preamp**

**complexity of fault file** analysis

**R&D project** - continual changes and performance push in the machine

How is this consistent with the operating machine?

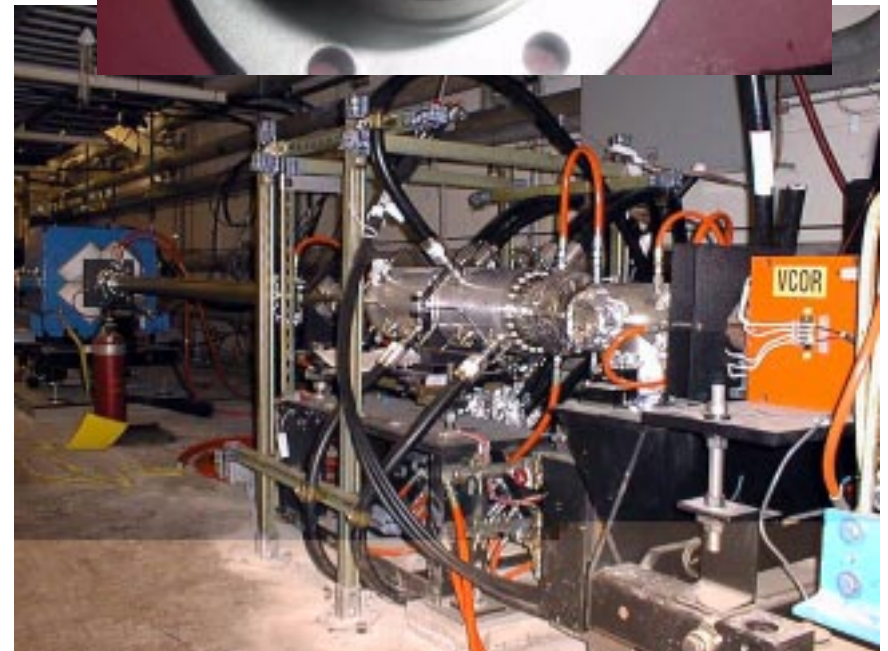

## Summary - Lessons learned

Were we successful in the feedback and LLRF areas because it was easy and we overdesigned/overestimated things?

### LLRF and RF dynamics

- Complexity of RF system, **stability of low modes**, operational issues - completely **underestimated**
- **Unexpected** low-mode instabilities -> **2 woofers**->klystron linearizer->finding **nonlinear amp**
- Operational intensity, issues of **constantly moving configurations** (klystrons on/off, gap voltages)
- **Manpower/skill** of operational support woefully **underestimated/under supported**

### Broadband (coupled-bunch) **longitudinal feedback**

- Essential techniques developed at ALS and other facilities - tremendous benefit to PEP-II
- Very lucky (wise?) design choices for detection frequency, scalability of output power

### What features were **essential for success**

- **Flexibility** (reprogrammability, modular architecture), close ties to **modelling/measurements**
- **Most important** element- Creative, highly curious **group** with concurrent physics/technology skills
- Diverse set of interesting challenges



## Acknowledgments

Thanks to D. Andersen, L. Beckman, M. Browne, P. Corredoura, J. Dusatko, M. Minty, P. McIntosh, C. Limborg, S. Prabhakar, W. Ross, J. Sebek, R. Tighe, U. Wienands, A. Young, H. Hindi, I. Linscott (Stanford), M. Tobiya, E. Kikutani (KEK), A. Drago, A. Ghigo, F. Marcellini, M. Serio (LNF-INFN), Shaukat Khan (BESSY), H. Kang (POSTECH), W. Barry, J. Byrd, J. Corlett, G. Lambertson, G. Stover and M. Zisman (LBL) for numerous discussions, advice and contributions.

The PEP-II LLRF Systems were inspired by Flemming Pedersen (CERN) and developed by P. Corredoura, R. Tighe, L. Sapozhnikov, B. Ross, J. Judkins, H. Schwarz, A. Hill (SLAC) and many others. System software was designed and coded by S. Allison, R. Claus, K. Krauter, K. Luchini and D. Teytelman (SLAC). We thank P. Baudrenghien and J. Tuckmantel for LHC-related collaboration.

The PEP-II LFB digital processing architecture and modules were skillfully designed and developed by G. Oxoby, J. Olsen, J. Hoeflich and B. Ross (SLAC) - System software was designed and coded by R. Claus (SLAC), I. Linscott (Stanford), K. Krauter, S. Prabhakar and D. Teytelman (SLAC)

The wideband longitudinal kicker for ALS and PEP-II was designed and developed by F. Voelker and J. Corlett (LBL). The kicker for DAFNE (PEP-II) was designed by R. Boni, A. Gallo, F. Marcellini, et.al.

Special thanks to Boni Cordova-Grimaldi (SLAC) for fabrication expertise and to the ALS, SPEAR, PEP-II, DAFNE, KEKB, PLS and BESSY-II operations groups for their consistent good humor and help. Work supported by U.S. Department of Energy contract DE-AC03-76SF0051



## Longitudinal Feedback System Features

Multiprocessor architecture fully implements ALS/BESSY-II/DAΦNE/PEP-II/PLS/SPEAR requirements. Scalable, flexible architecture for up to 8192 bunches with up to 500 MHz sampling rates.

- DSP processor - VME card, 4 AT&T DSP 1610s
- VME interface - Bus master for data distribution
- Downsampler - 500 MHz A/D and VXI Sequencer
- Hold Buffer - 500 MHz D/A and VXI Ring Buffer
- Timing - VXI oscillators ( $RF$ ,  $6 \times RF$ ,  $9/4 \times RF$ )
- Front-end - Comb filter followed by  $6 \times RF$  (3 GHz) phase detector - 600 MHz IF bandwidth
- Back-end - AM modulator transfers baseband kick to QPSK'ed carrier (1125 MHz, 1071 MHz, 1196 MHz, 1375 MHz).
- Software - VxWorks operating system for configuration and control with EPICS-based user interface
- Data analysis in Matlab, Automated diagnostics and setup tools
- Link error checking, temperature monitoring

## Grow/damp measurement example from PLS

A 30 ms long data set with 15 ms open-loop section.

All filled bunches participate in the modal motion. Transformation to the even-fill eigenmode basis simplifies the picture - there are three strong eigenmodes in this transient. Fitting complex exponentials to the modal motion we extract estimates of the modal eigenvalues for both open and closed-loop parts of the transient.

A single measurement like this only characterizes the instabilities and the feedback at a single accelerator operating point.

A very powerful technique is to measure modal eigenvalues as a function of beam current, RF system configuration, etc.

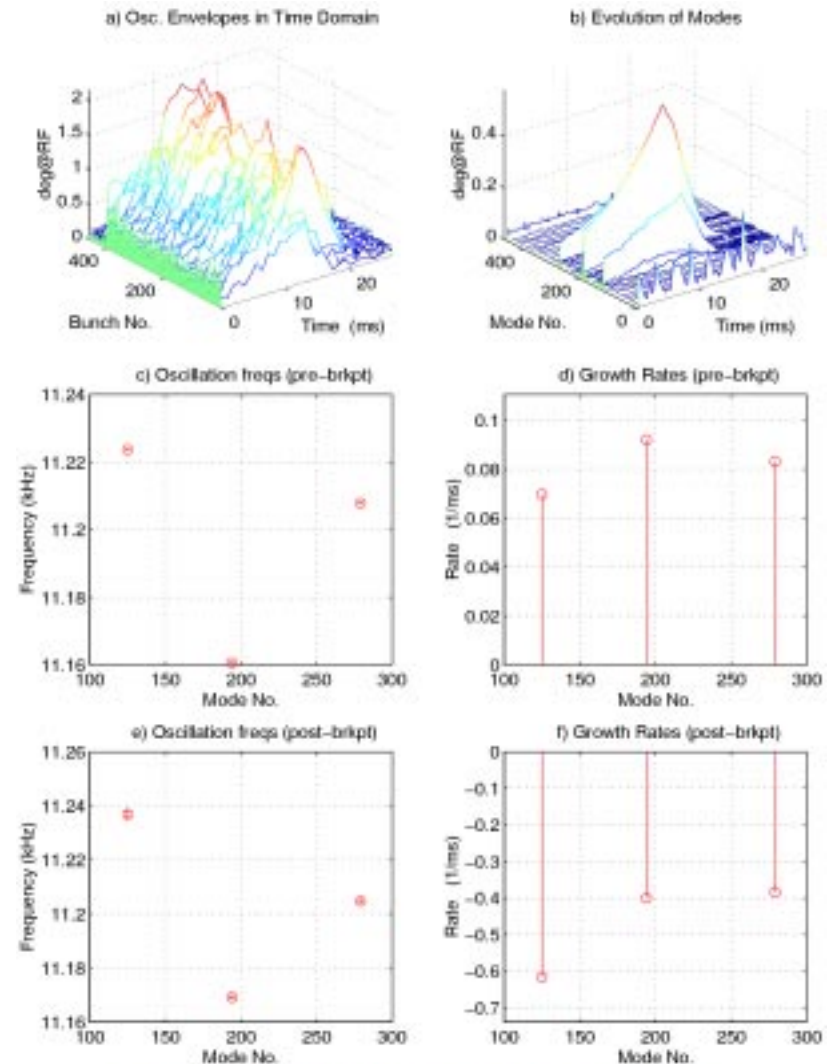

PLS-dec1599-1237: I<sub>av</sub>=150mA, D<sub>samp</sub>=15, ShfGains=5, Nbunch=460,  
Gain1=-1, Gain2=0, Phase1=30, Phase2=30, Brkpt=1100, Cell=11.02.

## LFB Flexibility - Quadrupole instability control

### DAFNE e+/e-collider at LNF

- increased operating currents
- **quadrupole mode** longitudinal instabilities have appeared (the installed system suppresses the dipole modes).

We implemented a novel quadrupole control filter

- software programmability of the DSP farm
- **two parallel control paths for dipole and quadrupole modes.**
- quadrupole control has been successful, allowing a 20% increase in luminosity.

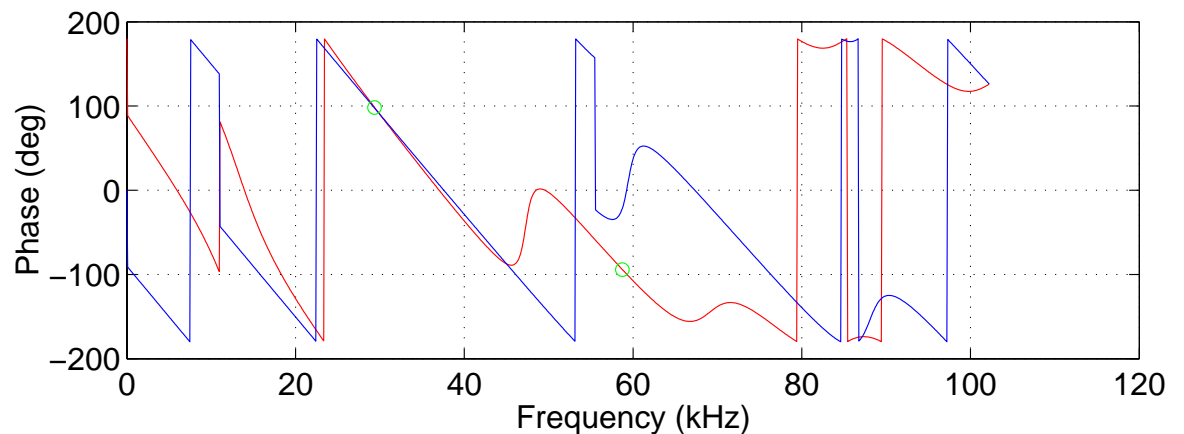
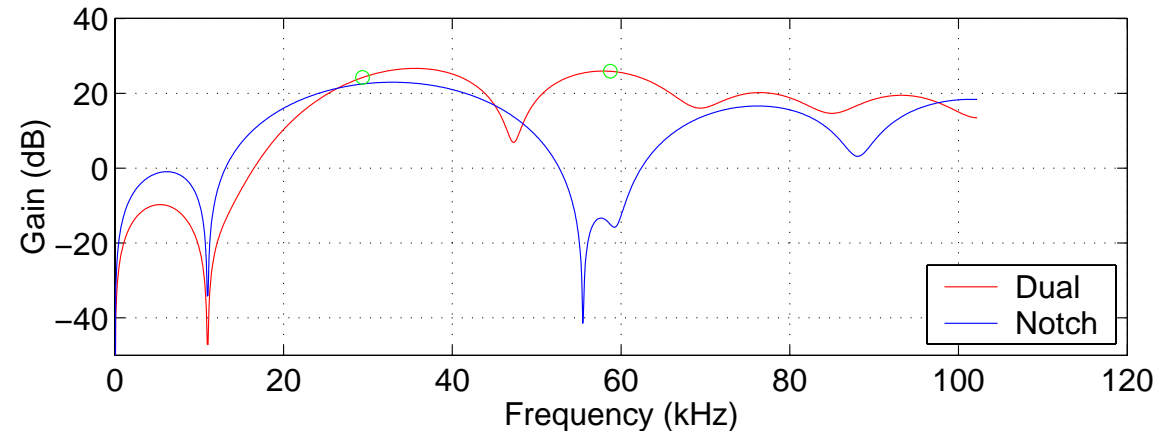

**ALS** added passive harmonic cavities (to address Touscheck-limited lifetime) - unanticipated effect giant tune change with current. Stability required a novel **negative group delay IIR Filter**



## Where We finished - LOM and HOM control

Last year of Operations

Plan to push from  $1.2E34$  to  $2E34$  - via current increase, bunch length, optics changes

Longitudinal stability- Data from LER 2900 mA

Growth/Damping rate isn't the issue. Strange interfering signals at 1100 Hz, etc. are a mystery

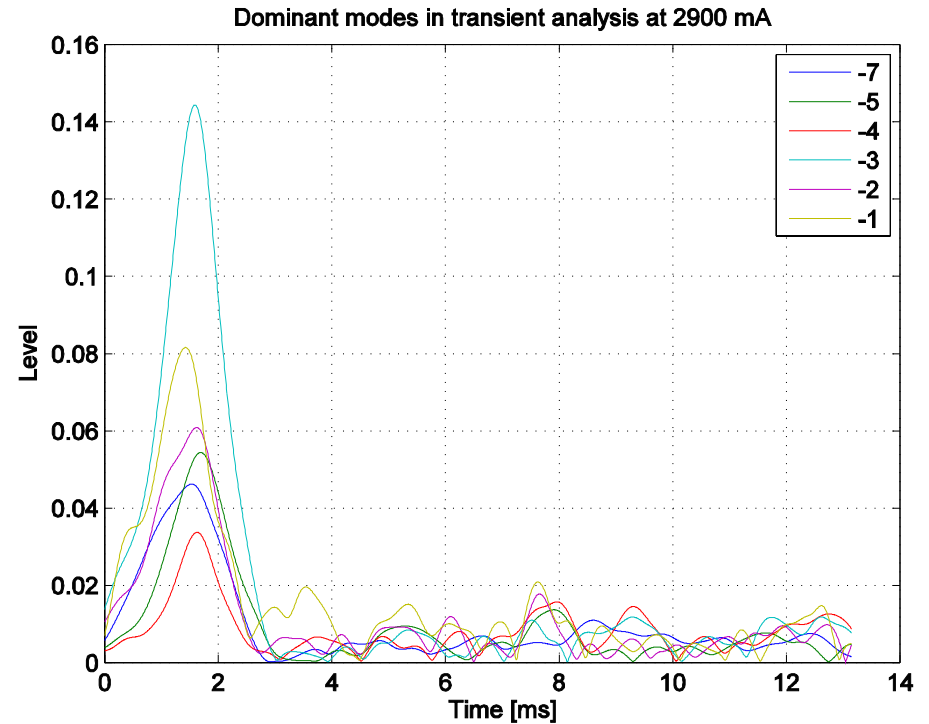
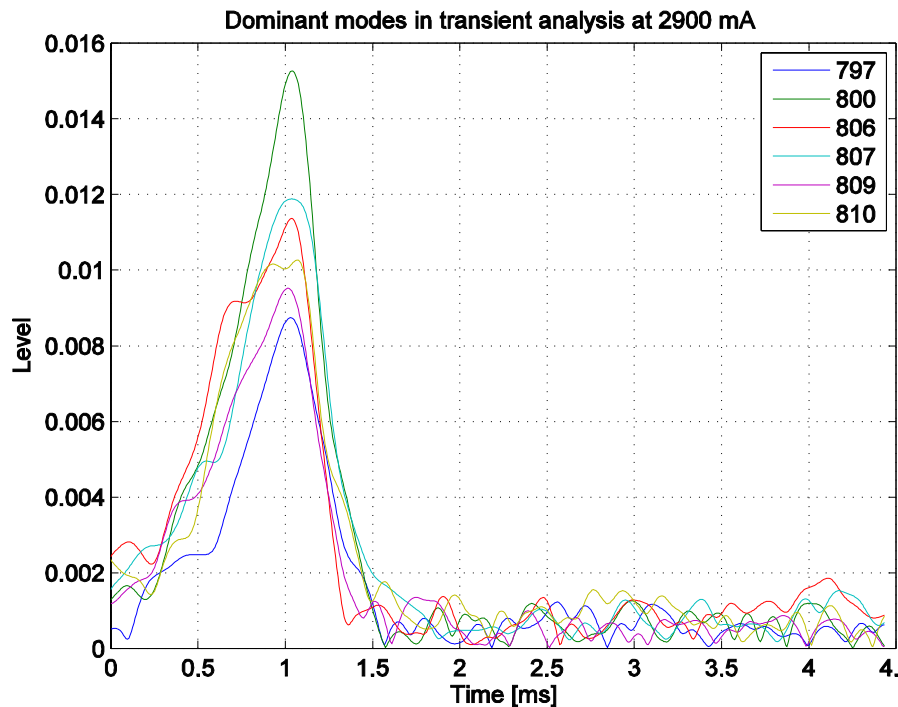



## Ultimate/Practical Limits to Instability Control

What Limits the **Maximum Gain** (e.g. fastest growth rate, or allowed impedance)?

Several Mechanism

I). **Noise** in feedback filter bandwidth, limits on **noise saturation**. Gain is from several stages -

**Front End** (BPM to baseband signal) gain limited by required oscillation dynamic range, steady-state offsets (synchronous phase transients, orbit offsets)

**Processing Block** - gain limited by noise in filter bandwidth. Quantizing noise (broadband) is one system limit - noise from RF system or front-end circuitry may also contribute. Narrowband filters help with broadband noise. Broad filter bandwidths help with reduced sensitivity to machine tunes, operating point - or variations of dynamics with current

**Power stages** - gain scales with kicker impedance,  $\sqrt{\text{output power}}$ . An expensive way to increase gain (more kickers, more output power).

**Output power** (actually maximum kicker voltage) determines maximum oscillation amplitude from which linear (non-saturated) control is possible. Saturated behavior is complicated



---

## Ultimate/Practical Limits to Instability Control

II) **Stability of the feedback loop** itself, (e.g. limits on phase shift and gain vs. control frequency)

Related to time delay between pickup, processing, and actuator

For circular machines (systems with kick signal applied on later turn than pickup)

limit set by revolution time, fastest growth rates, and filter phase slope over control band

Appropriate for optimal control theory applications

LQR

Robust Control

Uncertain Systems

Negative group delay over a portion of the frequency band is possible, but for causal systems you pay the price in increased phase slope away from the negative region