

# RF REFERENCE SIGNAL DISTRIBUTION SYSTEM FOR FAIR

M. Bousonville, GSI, Darmstadt, Germany  
 P. Meissner, Technical University Darmstadt, Germany

## Abstract

For the synchronisation of RF systems in the FAIR (Facility for Antiproton and Ion Research) synchrotrons and storage rings, an RF Reference Signal Distribution System is being developed. The FAIR RF cavities need signals with different phases and frequencies. Furthermore, frequency ramps with RF frequency ratios of up to 7 have to be realized in all rings. To enable this functionality, the distribution system provides two different clock signals to several locations within the facility that will be up to 1 km apart. By means of these clock signals, frequency generators can be synchronised that generate the RF signals needed for the cavities.

For the transmission of the clock signals, an optical network based on the DWDM method (Dense Wavelength Division Multiplex) will be used. The delay will permanently be measured and by means of the delay data, a clock regenerator produces a phase synchronous and stable reference signal at the end of each transmission line. A delay measurement accuracy of better than 100 fs has been achieved. The presentation focuses on the design of the system as well as on the performance of the prototype.

## INTRODUCTION

The objective is to synchronise the electrical fields of the cavities in the future facility (Fig. 1) whose target frequencies (0.4 to 5.4 MHz) and target phase are defined by nearby signal generators (Fig. 2).

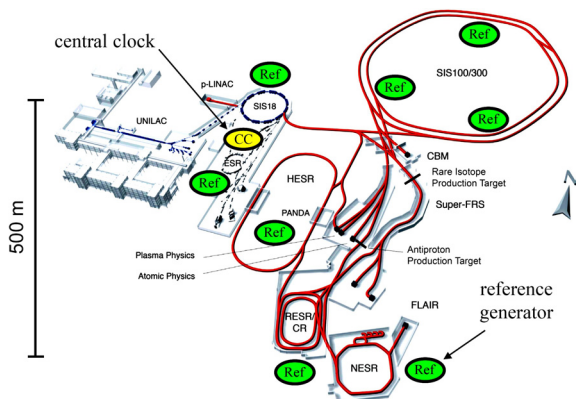

Figure 1: Facility for Antiproton and Ion Research.

The signal generators are frequency generators that work according to the DDS (direct digital synthesis) principle. To enable synchronous operation of the signal generators, these must be fed phase-synchronous reference signals. Reference Signal 1 (50 MHz) is used by the signal generator for digital signal synthesis, and Reference Signal 2 (97.7 kHz) is used to enable frequency and phase shift commands to be carried out synchronously. To generate the reference signals, two

clock signals (200 MHz & 97.7 kHz) are transmitted from a central point to the reference generators. These are able to derive from the clock signals, at several locations, reference signals which are frequency-synchronous with one another but which exhibit a phase displacement  $\Delta\varphi$  that depends on the respective delay of the clock signals  $\tau_n$ . To determine  $\Delta\varphi$ , the delays are measured. With the help of this information, phase corrections are effected in the reference generators and in this way the phases of the reference signals  $\varphi_{Ref}$  are synchronised. Since the delays are time-variable due to environmental influences, they must be measured on a permanent basis. By using only one transmitting and one measuring unit instead of one for each branch, respectively, the accuracy of the system is increased whilst lowering its costs.

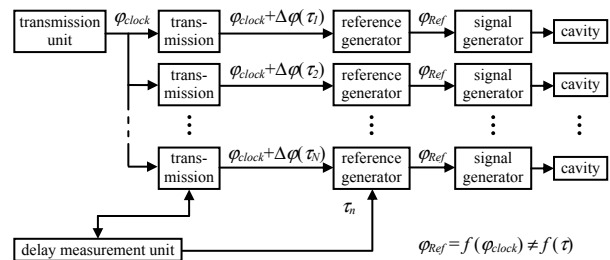

Figure 2: Basic Principle.

The purpose of the system presented here is to produce phase-synchronous and phase-stable reference signals at 13 spatially separate points of the facility. The phase shift between two reference points is not to exceed 514 ps, corresponding to  $1^\circ$  of the highest frequency occurring in the cavities. The system's accuracy is determined by Reference Signal 1.

## SYSTEM DESIGN

To achieve the primary objective of phase synchronisation, two new approaches are pursued. Firstly, the DWDM method is used for signal transmission and delay measurement, and secondly, phase correction is effected by means of reference generators operating according to the DDS principle.

### DWDM

For signal transmission, SMFs (standard single mode fibres) are used. The two clocks are optically multiplexed, i.e. they are modulated to two different optical wavelengths  $\lambda_1$  and  $\lambda_2$  and combined into one fibre in a multiplexer (Fig. 3). The two optical signals then pass through an add/drop multiplexer, the transmission line (SMF  $\leq 1$  km) and an FBG (fibre Bragg grating). In the demultiplexer, the wavelengths are separated again and fed to two separate receiver units.

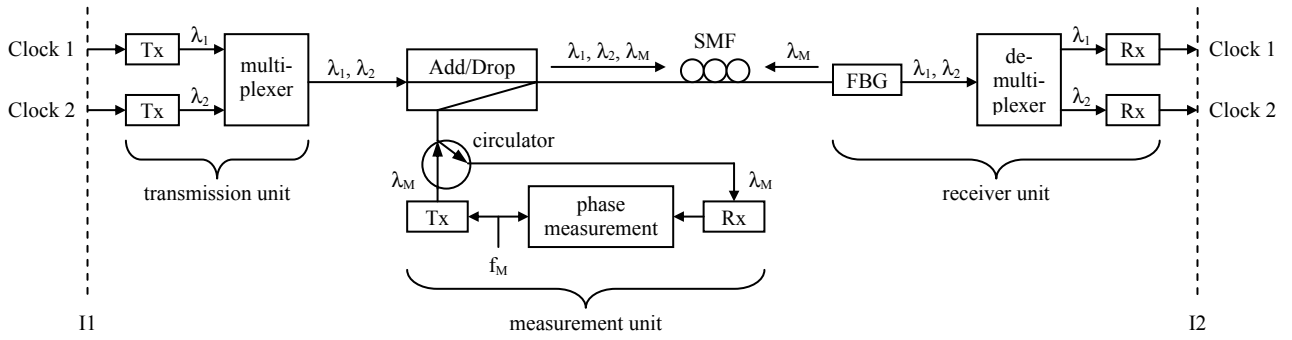

Figure 3: Configuration of one transmission branch with transmission and measurement unit.

The measurement signal for determining the delay is modulated to a third optical carrier  $\lambda_M$ . Via a circulator, the measurement signal is delivered to the add/drop multiplexer which combines the signals  $\lambda_1$ ,  $\lambda_2$  and  $\lambda_M$ . After passing through the SMF, all signals meet the FBG, which represents a wavelength-selective reflector that exclusively reflects  $\lambda_M$  while letting through the other two signals. The measurement signal now returns, is decoupled in the add/drop multiplexer and fed to the measurement receiver via the circulator.

*Star-shaped distribution*

Fig. 4 shows how the distribution to several points takes place. The optical signals are fed to several transmission lines via a power splitter. The attenuation of the splitter is compensated by an EDFA (erbium-doped fibre amplifier) [1]. With this approach, phase displacements in the optical transmitters, as described in [1-2], no longer matter because they affect all transmission branches equally and thus do not have any influence on the synchronisation of the phases of the reference signals.

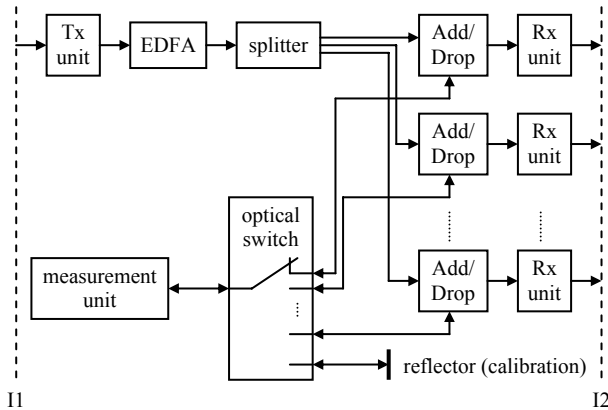

Figure 4: Star-shaped distribution.

*Measurement unit*

Only one measuring unit is used to determine the signal delay (Fig. 4). By means of an optical switch, the measurement signals are switched sequentially to the different branches and a reflector for calibration. Any remaining systematic errors are, up to the FBG, of the

same magnitude for all measurements and therefore irrelevant for the phase synchronisation of the reference signals. For measuring, one sinusoidal oscillation  $f_M$  after the other is modulated to  $\lambda_M$  and a phase comparison of the outgoing and returning signal is performed (Fig. 3). This is done five times with frequencies between 30 kHz and 6 GHz. From the phase values obtained, the signal delay of the clocks, taking account of dispersion, can be finally determined. The accuracy of the measurement  $\tau_{accu}$  depends on the highest measurement frequency  $f_{max} = 6$  GHz and the accuracy of the phase meter  $\phi_{accu} < 0.4^\circ$ .

$$\tau_{accu} < \frac{1}{f_{max}} \frac{\phi_{accu}}{2 \cdot 360^\circ} = 92.6 fs \quad (1)$$

*Reference signal generator*

In Fig. 5, DDS units 1 and 2 are provided with the clocks and generate the reference signals with a phase displacement  $\Delta\phi$  which depends on delay  $\tau$ . Since the delay is known, the  $\Delta\phi$  and thus the correction data  $\phi_{cor}$  can be calculated from it for the DDS units. Next, the DDS units perform a phase correction. This is carried out regularly in each system branch depending on the current delays. In this way the phases of the reference signals are synchronised. The resolution of phase adjustability  $\phi_{res}$  depends of the length of the phase/offset word  $n_{POW}$  of the DDS unit (14 bit for the prototype) and the generated frequency. For Reference Signal 1, this is

$$\phi_{res} = \frac{1}{2^{n_{POW}} \cdot f_{Ref,1}} \approx 1.22 ps \cdot \quad (2)$$

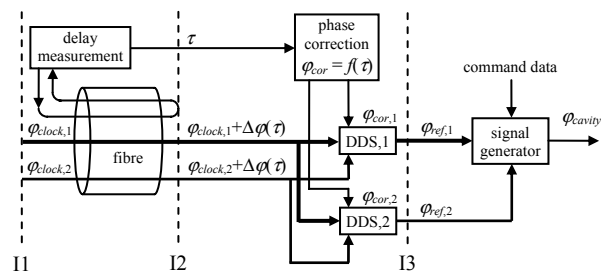

Figure 5: Reference signal generation.

## PERFORMANCE

### Noise

Since all receivers are fed about 0 dBm of optical power, not the receiver noise is dominant but the relative intensity noise (RIN) of the laser in signal transmission (also the noise of the EDFA is lower [3]) and Rayleigh backscattering in the measurement signal. Assuming 100 % modulation of the optical carrier and 1 km of fibre length, this results in measured signal-to-noise ratios of > 143.2 dBc/Hz for clock transmission and 93.8 to 101.3 dB, depending on the frequency, for the measurement signal (bandwidth 10 Hz). This is greater than that of the phase meter and therefore negligible in (Eq. 1).

### Verification of measurement accuracy

To verify the delay measurement, the influence of the delay drifts of the receivers [1-2] had to be eliminated. For this purpose, the optical switch was located after the add/drop multiplexer of one transmission branch. At two outputs, SMFs (1 km and 100 m) were connected and their ends combined again by means of a coupler into one FBG to which only one receiver was connected. Using a network analyser, the transfer functions of this test setup were measured every 4 s with a 6 GHz sinusoidal signal in both switch settings. By comparing the results, the phase displacement was determined. This phase displacement was also determined by the parallel delay measurement and compared with the control measurement of the network analyser. The result can be seen in Fig. 6; the deviation was less than  $\pm 60$  fs.

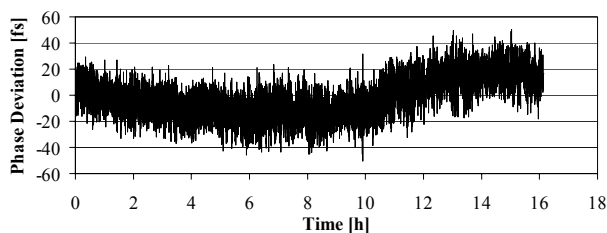

Figure 6: Control measurement.

### Jitter

Due to transmission noise, an RMS jitter of < 305 fs is added to Clock 1. This has negligible influence on Reference Signal 1 since the inherent jitter of the DDS unit is  $\leq 7.6$  ps and thus determines the short-term jitter of the entire system.

### Phase synchronisation

The phase deviation of the reference signals at two different endpoints was measured over a period of 15 hours and was < 15 ps, which exceeds the accuracy requirement by more than one order of magnitude (Fig. 7). The prototype system synchronised the phases every 4 s, compensating delay fluctuations of up to 106 ps (transmission lines  $\geq 1$  km). Presumably, the remaining deviations are caused by delay drifts of the receivers [1-2].

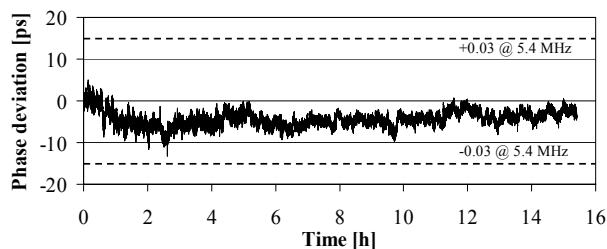

Figure 7: Phase deviation (average interval 1 s).

### Phase stability/Allan deviation

Phase stability and the Allan deviation between two reference generators are given in Table 1.

Table 1: Measured Phase Stability/Allan Deviation

Time Interval	Phase Stability	Allan Deviation
1 s	535 fs	$6.37 \cdot 10^{-13}$
10 s	438 fs	$4.38 \cdot 10^{-14}$
100 s	814 fs	$8.45 \cdot 10^{-15}$
1000 s	913 fs	$9.59 \cdot 10^{-16}$

## PROSPECTS

By means of the parameters  $f_{max}$ ,  $n_{POW}$ ,  $f_{Ref,1}$  in (Eq. 1) and (Eq. 2) as well as the use of different DDS units and a temperature stabilisation of the receiver units, the system's performance can be improved further.

## SUMMARY

The use of DWDM and an EDFA makes it possible to achieve very good signal-to-noise ratios in transmission of both the clocks and the measurement signal. This, combined with the decoupling of the measurement system from clock transmission, facilitates very accurate delay measurements. The prototype is capable of providing phase-synchronous reference signals with a mean accuracy of  $\pm 15$  ps, corresponding to  $\pm 0.03^\circ$  of the rf phase of the cavities. Thanks to the use of standard components and only one transmitting and one measurement unit, the method is cost-efficient.

## REFERENCES

- [1] T. Kobayashi, et al., "RF Reference Distribution System for the 400-MeV Proton Linac of the KEK/JAERI Joint Project". Proc. of the LINAC 2002, pp. 187-189, 2002.
- [2] K. Czuba, et al., „First Generation of Optical Fiber Phase Reference Distribution System for TESLA“, CARE-Report-2006-037-SRF.
- [3] E. Desurvire, „Erbium Doped Fiber Amplifiers“, Wiley Interscience, 2002.