

MODELING AND SIMULATION OF THE LONGITUDINAL BEAM DYNAMICS - RF STATION INTERACTION IN THE LHC RINGS *

T. Mastorides[†], C. Rivetta, J.D. Fox, D. Van Winkle, SLAC, Stanford, CA 94309, USA
P. Baudrenghien, J. Tückmantel, CERN, Geneva, Switzerland

Abstract

A non-linear time-domain simulation has been developed to study the interaction between longitudinal beam dynamics and RF stations in the LHC rings. The motivation for this tool is to determine optimal LLRF configurations, to study system sensitivity on various parameters, and to define the operational and technology limits. It will be also used to study the effect of RF station noise, impedance, and perturbations on the beam life time and longitudinal emittance. It allows the study of alternative LLRF implementations and control algorithms. The insight and experience gained from our PEP-II simulation is important for this work. In this paper we discuss properties of the simulation tool that will be helpful in analyzing the LHC RF system and its initial results. Partial verification of the model with data taken during the LHC RF station commissioning is presented.

SYSTEM DESCRIPTION AND MOTIVATION

The LHC and PEP-II LLRF systems follow the same fundamental architecture. Detailed descriptions of the systems have been presented for LHC [1] and PEP-II [2]. Both systems employ feedback techniques to regulate the cavity voltage and phase, to reduce the impedance seen by the beam, and to increase the beam stability.

For PEP-II, the beam stability for the modes driven by the cavity fundamental impedance was critical, especially at high currents. Linear models had been developed, but they had failed to predict the system limitations. The PEP-II time-domain simulation we developed had good agreement with the measured growth rates of the cavity driven modes. The simulation was subsequently used to study the RF configurations that would maximize the achievable currents, predict the architecture's limits, determine imperfections in the LLRF, and test upgrades, without spending valuable machine time [3]. Through this work, improvements such as the comb phase rotation and the new driver amplifiers were implemented and reduced the interaction between the beam dynamics and the RF station.

With the LHC simulation we will evaluate the regulation of the cavity signals, study the necessary technical specifications of the various sub blocks, understand how the technical implementation impacts the system performance, predict limits of accelerator performance, and consider the

effect of possible modifications and upgrades. In addition, the simulation will be used to study how the noise and imperfections in the LLRF systems can contribute to growth in longitudinal emittance and reduction in beam life time. We would like to estimate the effect of different control algorithms to mediate this problem.

Even though the critical issues are different for the two facilities, in both cases they result from the interaction between the longitudinal beam dynamics and the LLRF system. This fact allows us to use our simulation model and our experience from the PEP-II operations and analysis, as a basis for the LHC studies. In both cases we model the subsystems that act in a fast time scale and affect the beam-RF station interaction.

The simulation model will also be helpful during the LHC commissioning, since it will be used in the development of the LHC identification and configuration tools described in this paper. These tools allow us to optimally configure the RF stations and remotely access the RF system for tuning and measurements. During operations the tools will help compare the machine's performance with the one predicted by the simulation.

An earlier simulation effort by J. Holma [4] was used to study and set-up the loops on a full-scale test bunch that included the LLRF, klystron, and cavity. This initial model did not include the beam dynamics.

MODEL DESCRIPTION

A detailed block diagram and description of the LHC LLRF components can be found in [1]. The components modeled in our simulation model include the accelerating super-conducting cavity with an R/Q of 45 and a resonance frequency of 400.8 MHz, the 300 kW klystron, the klystron polar loop, the impedance controlling feedback (both digital and analog paths), and the beam. The klystrons used at PEP-II and LHC are inherently non-linear. The klystron polar loop used at the LHC acts around the klystron to reject power supply perturbations and compensate the gain and phase shift of the klystron for different operation points. To accurately describe the system, reduced models of the individual components are included in the simulation. The waveguide, cable, and processing delays are included, and the gains and phases of the RF feedback components are adjusted in a similar manner as for the real machine. The 1-Turn feedback (comb), which acts to reduce the impedance at the synchrotron sidebands, has not reached the hardware commissioning phase yet, but will be validated when data is available during commissioning.

The simulation is developed as a block system in

* Work supported by the U.S. Department of Energy under contract # DE-AC02-76SF00515

[†] themis@slac.stanford.edu

Simulink. The slow loop dynamics (software control regulators) are sufficiently slow compared to the time scale of the simulation that they are calculated as initial conditions (constants) in Matlab. A simplified version of the simulation block diagram can be seen in Figure 1.

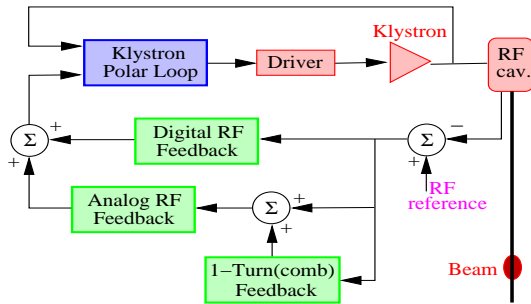
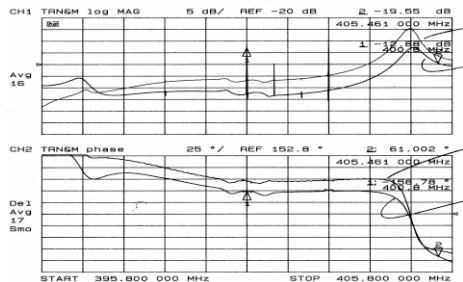

Figure 1: Simulation block diagram.

VALIDATION

For the initial simulation validation, we used transfer function measurements of the LHC RF stations during the RF hardware commissioning. In Figure 2 we show the klystron transfer functions from the measurements and the



(a) LHC Measured Klystron Transfer Function

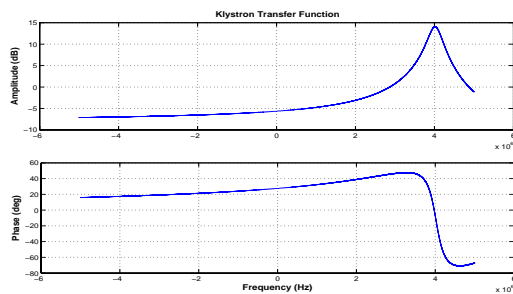

(b) SLAC Simulated Klystron Transfer Function

Figure 2: Klystron Transfer Functions

simulation, as measured from the input of the *Driver* to the output of the *Klystron* as shown in the block diagram (Figure 1). The klystron transfer function exhibits a secondary resonance at 404.8 MHz with a *Q* of 1100. The simulation shows these characteristics with good agreement in amplitude. The phase discrepancy between the plots is due to delay calibration offsets included in the network analyzer used for the LHC measurements and is consistent in all the LHC measurements shown in this paper.

The superconducting cavity and the klystron polar loop are then measured in the real machine and the simulation. The resulting transfer functions from the input of the klystron polar loop to the output of the cavity can be seen in Figure 3 showing once again good agreement. In the

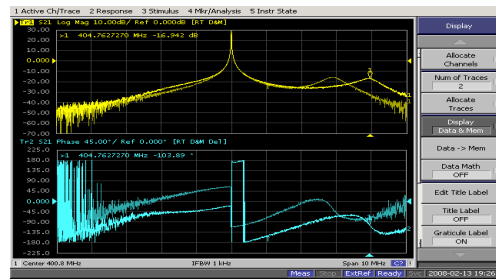

(a) LHC Measured Open Loop RF station Transfer Function. Two different klystrons shown, the one with an incorrect resonance at 403.8 MHz.

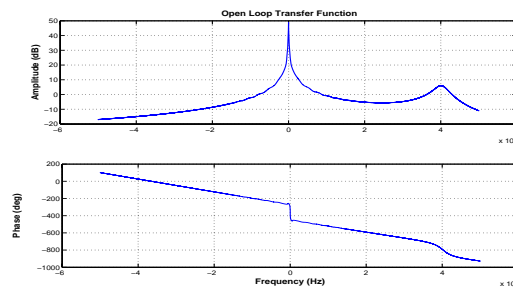

(b) SLAC Simulated Open Loop RF station Transfer Function

Figure 3: Open Loop RF station Transfer Functions.

simulated plot, one can see the effect of the system delay.

Finally, in Figure 4 we show the transfer function of the RF station, with the RF feedback loop regulating the system. The RF feedback's amplitude and phase are adjustable in the simulation, as in the real machine.

As can be seen from these figures, there is a close agreement between the and the measurements of the real RF system at LHC.

IDENTIFICATION AND CONFIGURATION TOOLS

The LHC RF station configuration and measurement of variables can only be conducted remotely during operations, due to the location of the stations. The LLRF controller's parameters for each station are calculated based on an analytic model of the system. This model is dependent of the operating point of the RF station and it is measured and calculated through an identification process while the system is operating. The identification tool should be able to measure the transfer function of the RF station in open loop during commissioning and in closed-loop when the system is operating with beam in the machine.

The identification tool operates by injecting a band-limited low-level noise signal into the system. The time-domain input signal and the response of the RF station to

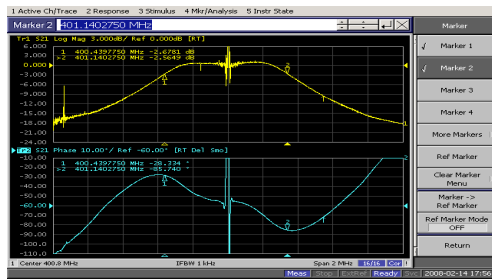

(a) LHC Measured Closed Loop RF station Transfer Function

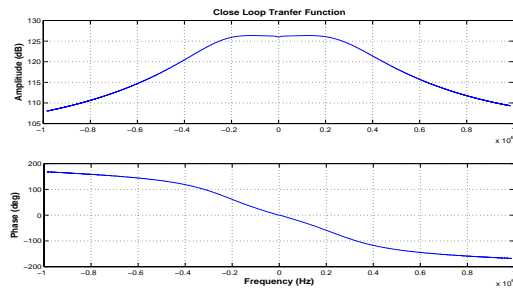

(b) SLAC Simulated Closed Loop RF station Transfer Function

Figure 4: LHC Measured Closed Loop RF station Transfer Functions.

that excitation are measured simultaneously. The transfer function is estimated by using a correlation algorithm between the input/output time-domain signals. To get an analytical representation of the estimated transfer function, a linear reduced model of the RF station is fitted to the estimated data. This model is the base for the design of the LLRF controller of the station [5].

The simulation allows to set and test different algorithms of identification and reduced models to define the analytic transfer function of the RF stations before the final commissioning of the tool. Results from these test are depicted in Figure 5, where the transfer functions of the klystron and cavity are estimated and the corresponding analytical model is fitted.

CONCLUSION AND FUTURE DIRECTIONS

The LHC simulation has successfully passed the first validation effort. The simulation development has been helpful in reaching a deeper understanding of the LHC LLRF. It is being used to develop the identification and configuration algorithms, which will be very helpful during commissioning and operations to measure the system. In addition, the simulation is a path to develop an optimal control algorithms.

To expand the simulation model's capabilities, the 1 Turn Feedback (comb) and the Klystron Driver Smoother module [6] (which reduces the gap transients), are currently added to the model. The 1 Turn Feedback will be validated when RF hardware commissioning data becomes available.

06 Instrumentation, Controls, Feedback & Operational Aspects

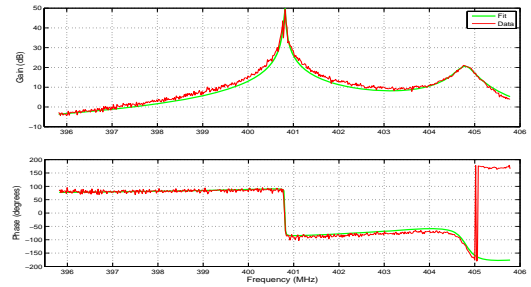

Figure 5: RF station transfer function based on simulated data and fitted linear model.

The development of algorithms to commission and optimally configure the actual hardware with and without beam is an essential task, which is being developed. Also, we plan to study the effect of noise, perturbations signals, nonlinearities, finite precision arithmetic, cross talk in RF processing, and mismatch in I,Q downconversion on the system performance. We would like to explore the effect of these perturbations on the growth of the longitudinal emittance. Since the time range of the simulation is too small, a diffusion model will be developed, which would use our simulation results to determine these effects. Future directions also include the definition of the acceptable injected noise level for the RF station identification and the optimal configuration setting.

ACKNOWLEDGMENTS

The authors would like to thank the CERN RF group for their interest in this work, the valuable data, their help and ideas. We would also like to acknowledge the support for this LHC collaboration from the SLAC ATR department and the US LARP program.

REFERENCES

- [1] P. Baudrenghien *et al.*, "The LHC Low Level RF", EPAC '06, Edinburgh, Scotland, June 2006.
- [2] C. Rivetta *et al.*, "Modeling and Simulation of Longitudinal Dynamics for Low Energy Ring-High Energy Ring at the Positron-Electron Project", Phys. Rev. ST-AB, 10, 022801 (2007).
- [3] T. Mastorides *et al.*, "Analysis of Longitudinal Beam Dynamics Behavior and RF System Operative Limits at High Beam Currents in Storage Rings.", Phys. Rev. ST-AB, to be published June 2008.
- [4] J. Holma, "The Model and Simulations of the LHC 400 MHz Cavity Controller", CERN-AB-2007-012, CERN, Feb. 2007.
- [5] D. Teytelman, "A Non-invasive Technique for Configuring Low Level RF Feedback Loops in PEP-II", Proc. IEEE Particle Accelerator Conference, Knoxville, TN 2005 and SLAC-PUB-11252, May 2005.
- [6] J. Tückmantel, "Adaptive RF Transient Reduction for High Intensity Beams with Gaps", EPAC '06, Edinburgh, Scotland, June 2006.