

# Development of a Low-latency, High-precision, Intra-train Beam Feedback System Based on Cavity Beam Position Monitors

N. Blaskovic Kraljevic, D. R. Bett, P. N. Burrows,  
G. B. Christian, M. R. Davis, Y. I. Kim, C. Perry  
*John Adams Institute, University of Oxford, UK*

# Outline

- Introduction
  - Feedback at a linear collider
  - International Linear Collider
  - Feedback on Nanosecond Timescales
- Experimental setup at Accelerator Test Facility
- Cavity beam position monitor signals
- Modes of feedback operation
- Results

# Feedback at a Linear Collider

- Successful collision of bunches at a linear collider is critical
- A fast position feedback system is required

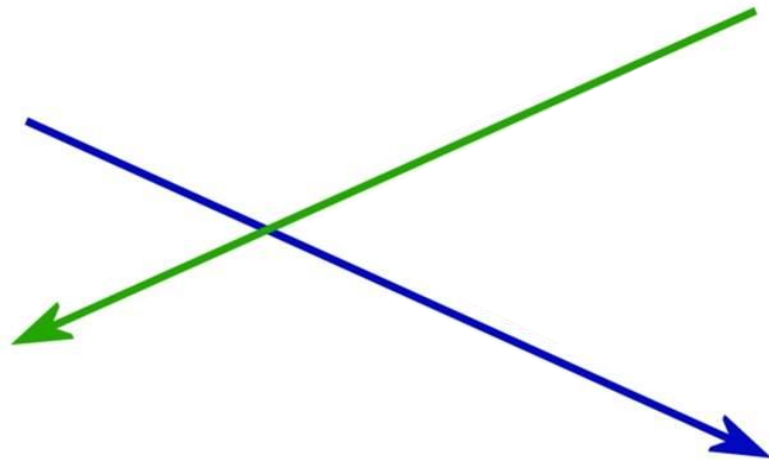

Misaligned beams at interaction point (IP) cause beam-beam deflection

# Feedback at a Linear Collider

- Successful collision of bunches at a linear collider is critical
- A fast position feedback system is required

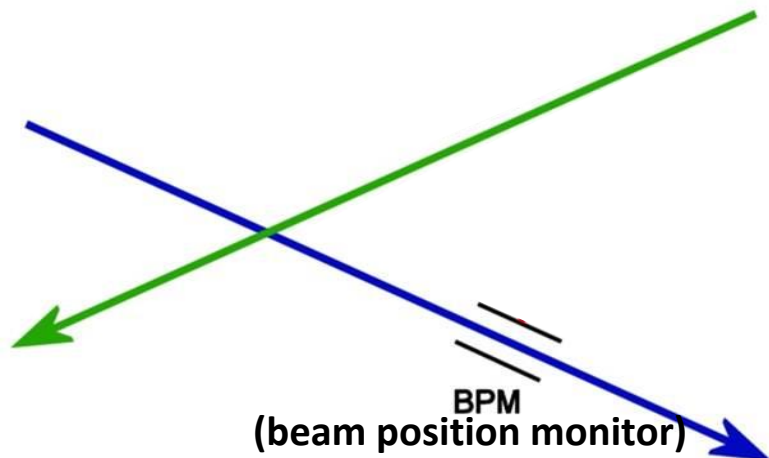

Misaligned beams at interaction point (IP) cause beam-beam deflection

Measure deflection on one of outgoing beams

## Feedback at a Linear Collider

- Successful collision of bunches at a linear collider is critical
- A fast position feedback system is required

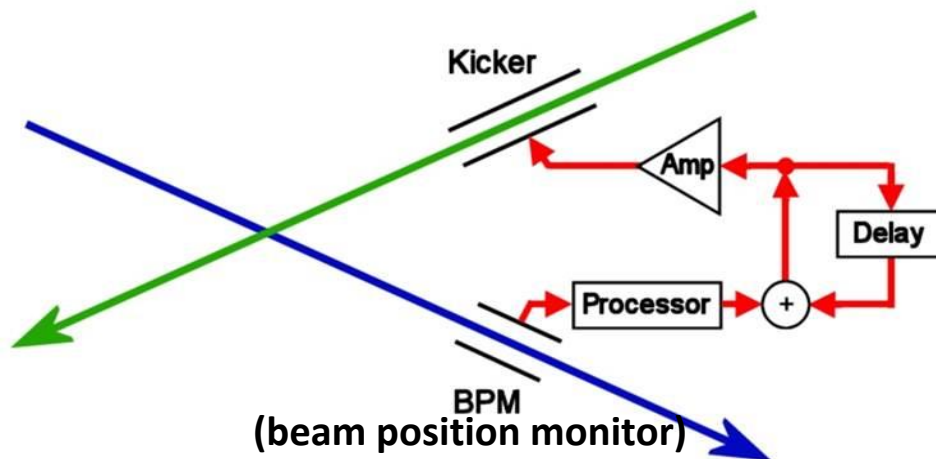

Misaligned beams at interaction point (IP) cause beam-beam deflection

Measure deflection on one of outgoing beams

Correct orbit of next bunch (correlated to previous bunch due to short bunch spacing)

# International Linear Collider (ILC)

- Proposed linear electron-positron collider
- Centre-of-mass energy: 250-1000 GeV
- Vertical beamsizes: 5.9 nm
- Bunch separation: 554 ns

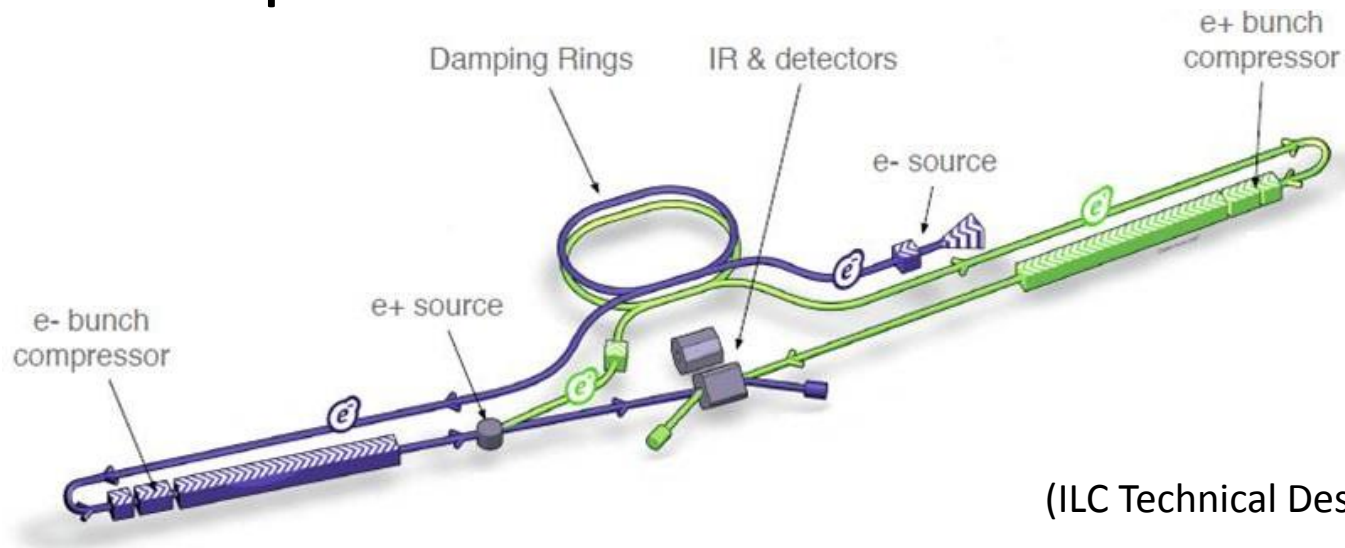

# Accelerator Test Facility (ATF) at KEK

- Test bed for the International Linear Collider
- Facility located at KEK in Tsukuba, Japan
- Goals:
  - 37 nm vertical spot size at final focus
  - Nanometre level vertical beam stability



# Introduction

## Accelerator Test Facility (ATF) at KEK

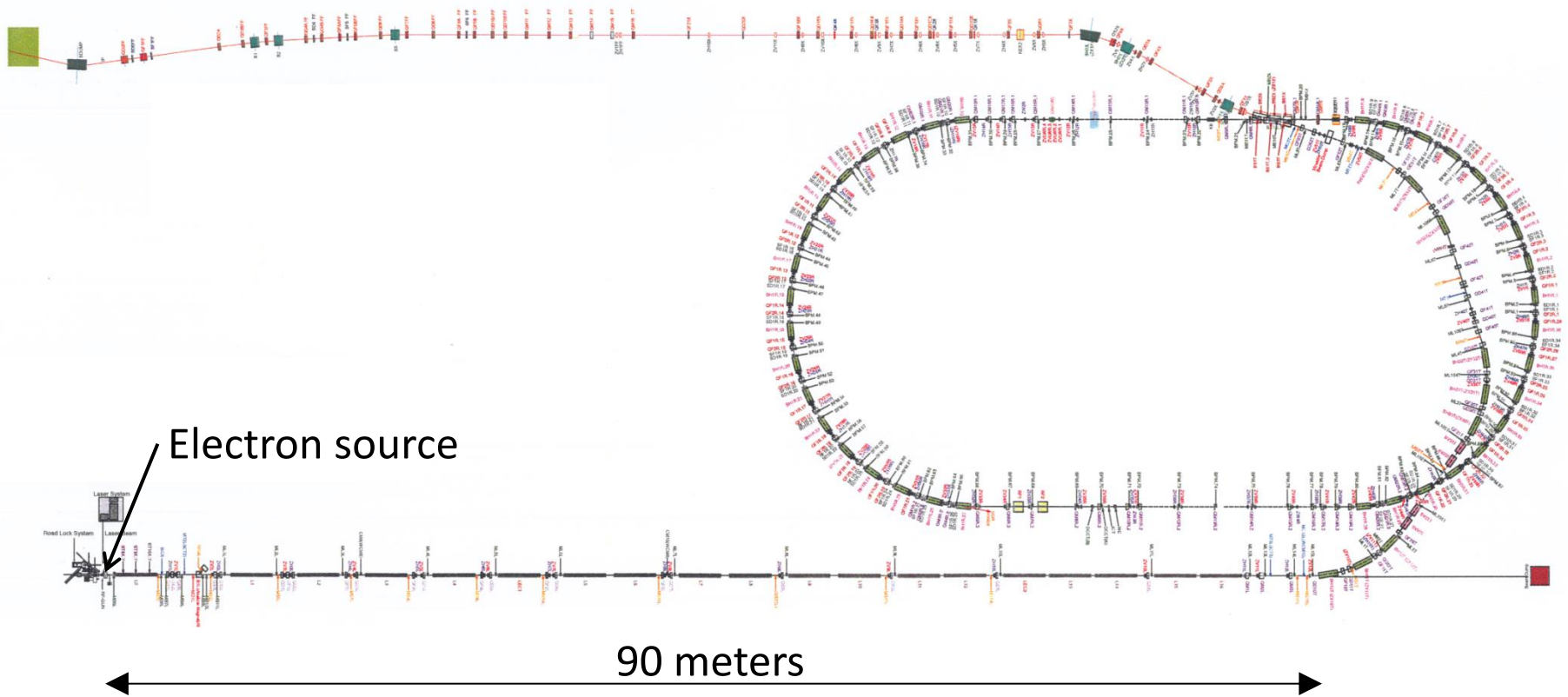



# Introduction

## Accelerator Test Facility (ATF) at KEK

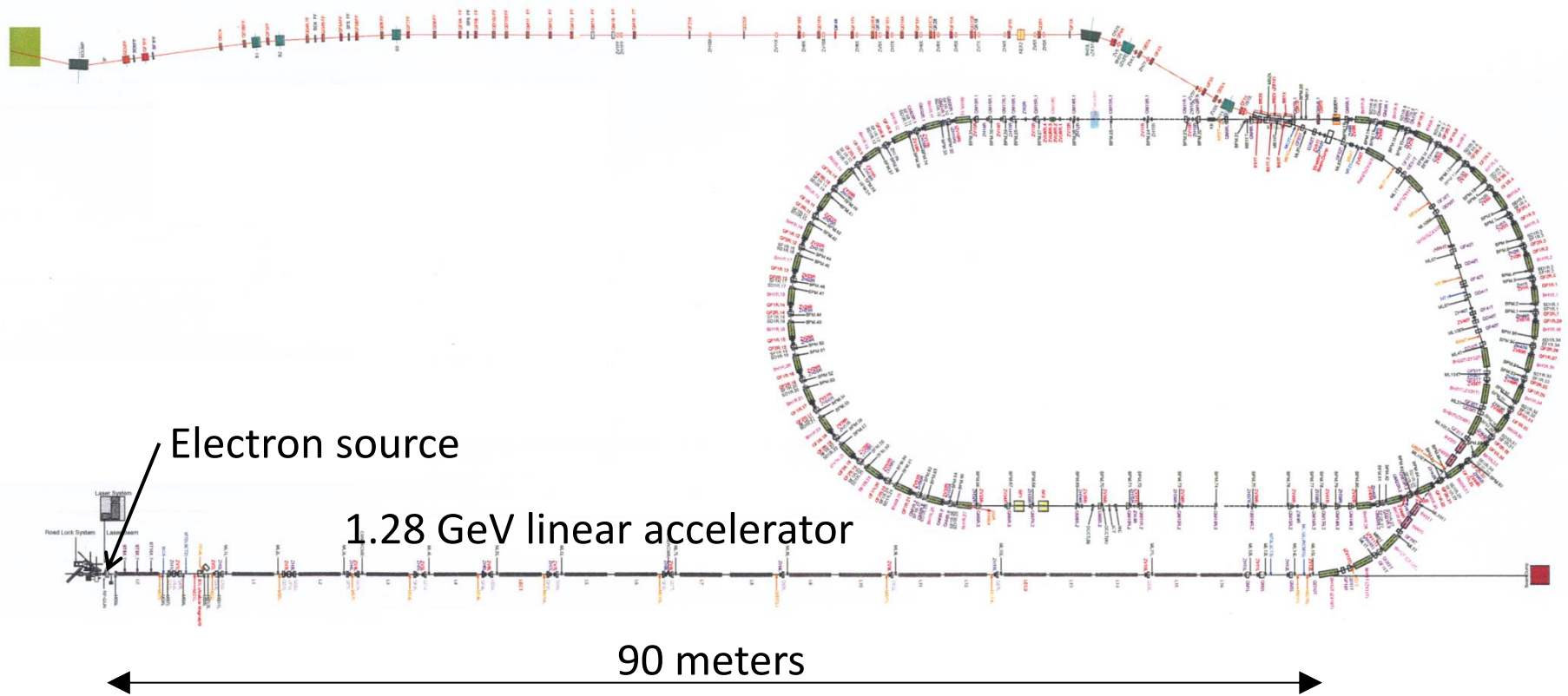

# Introduction

# Accelerator Test Facility (ATF) at KEK

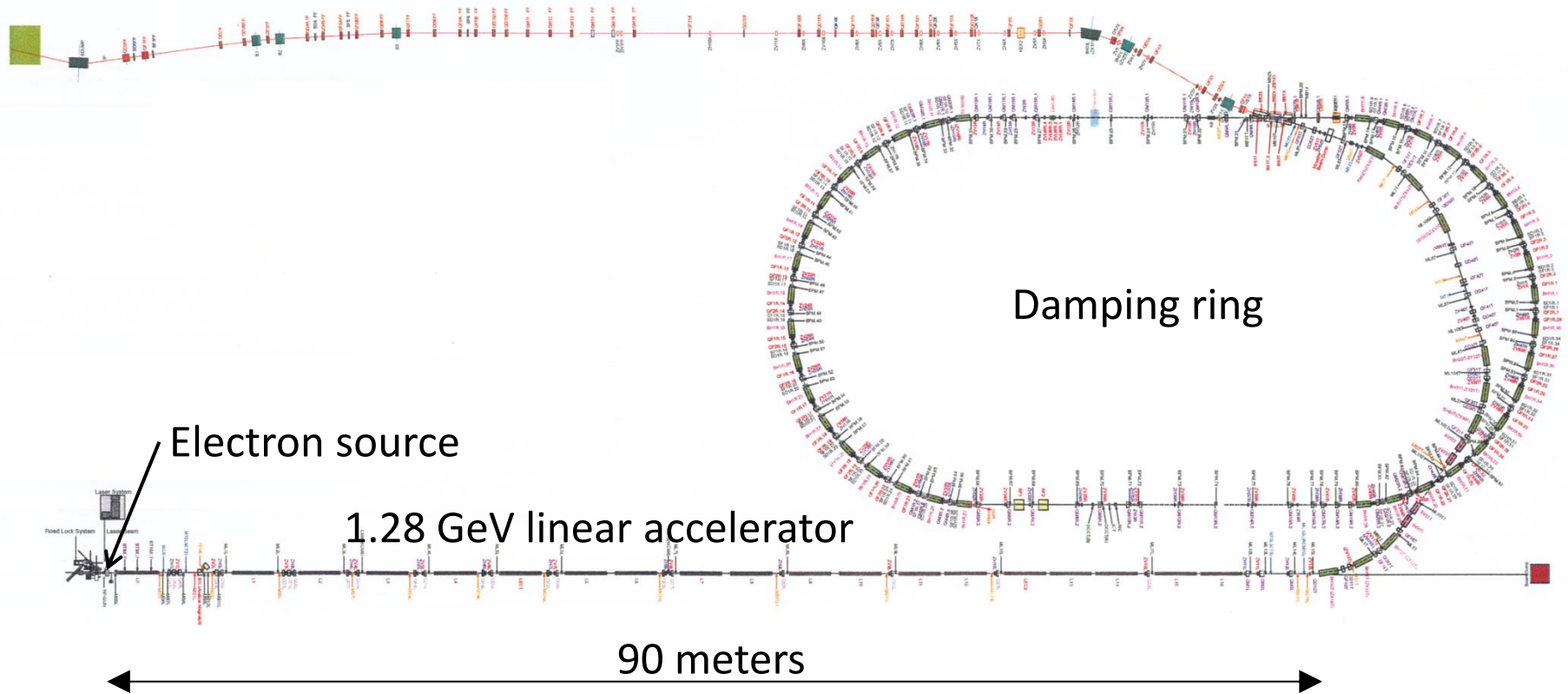

# Introduction

# Accelerator Test Facility (ATF) at KEK

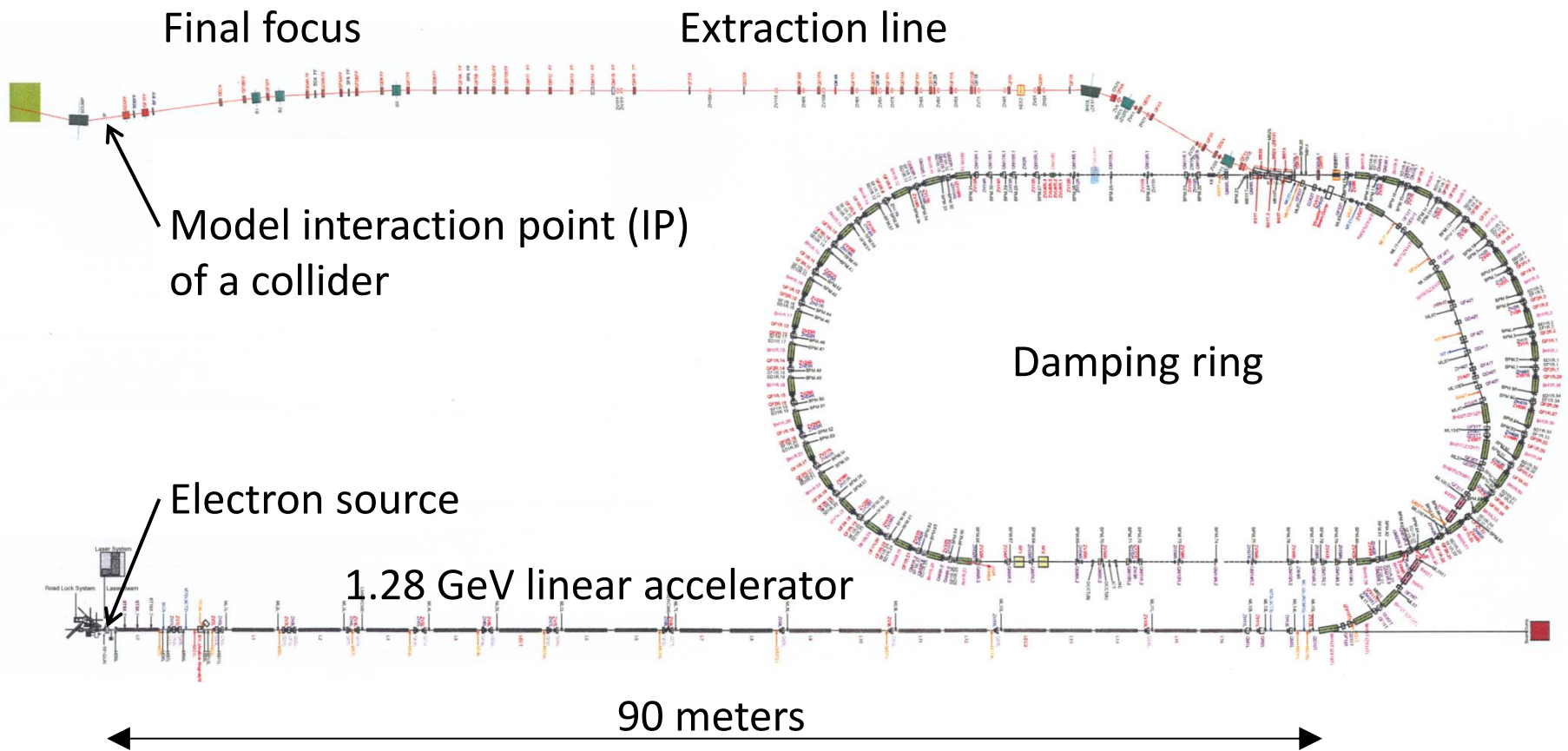

# Introduction

# Accelerator Test Facility (ATF) at KEK

## Feedback system

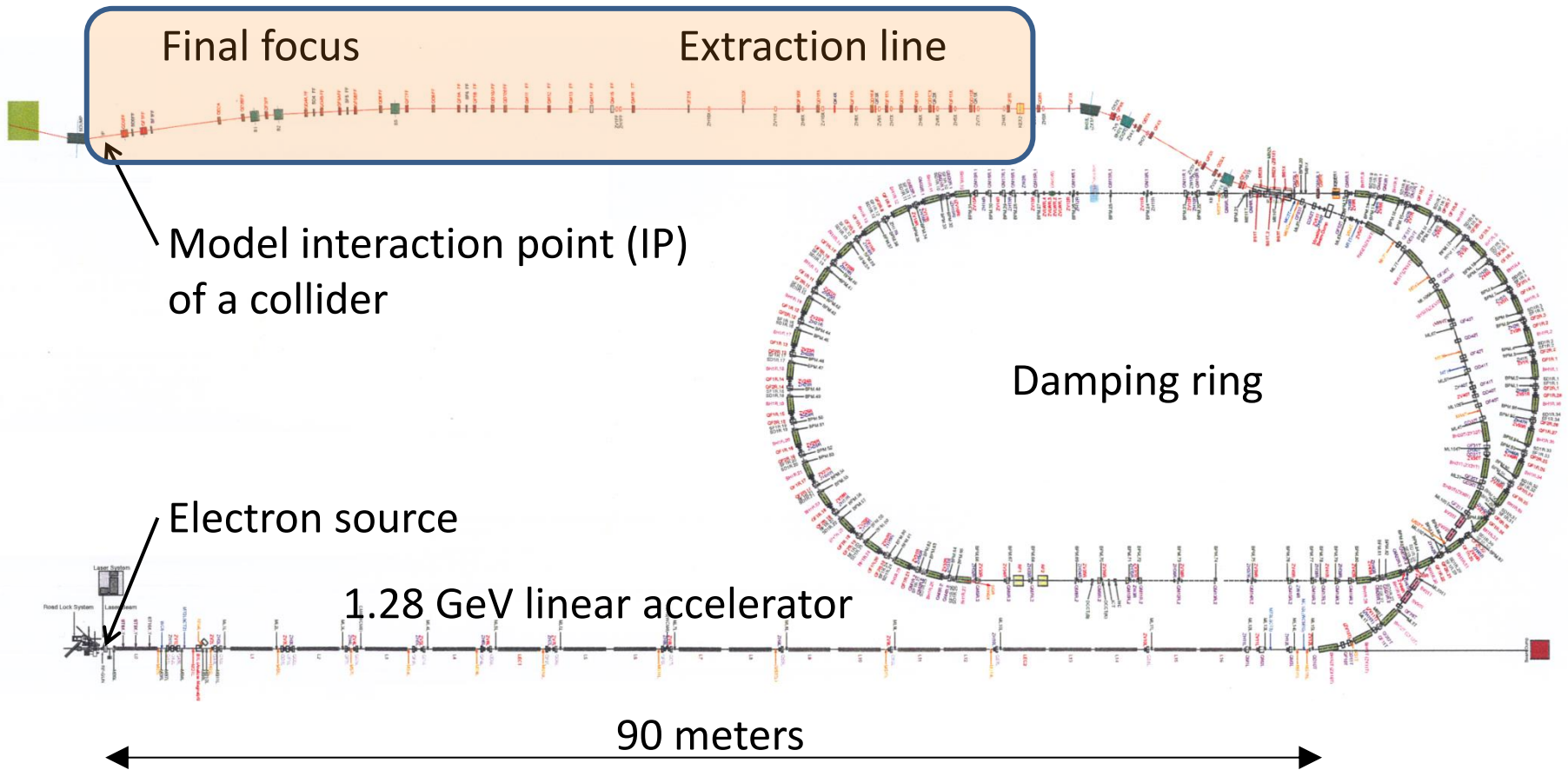

# Accelerator Test Facility (ATF) at KEK

- ATF can be operated with 2-bunch trains in the extraction line and final focus
- The separation of the bunches is ILC-like (tuneable up to  $\sim 300$  ns)
- Our prototype feedback system:
  - Measures the position of the first bunch
  - Then corrects the path of the second bunch
- Train extraction frequency:  $\sim 3$  Hz

# Feedback on Nanosecond Timescales (FONT)

- Low-latency, high-precision feedback system
- We have previously demonstrated a system meeting ILC latency, BPM resolution and beam kick requirements
- We have extended the system for use at ATF
- We aim for nanometre level beam stabilisation

# Experimental Setup



## P Stripline BPM

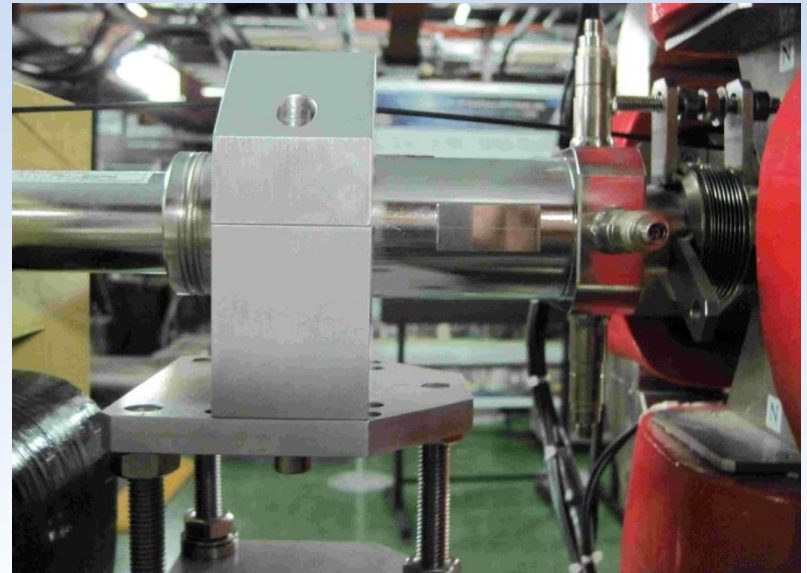

- 12 cm long strips
- 12 mm radius
- On x and y mover system



# Experimental Setup

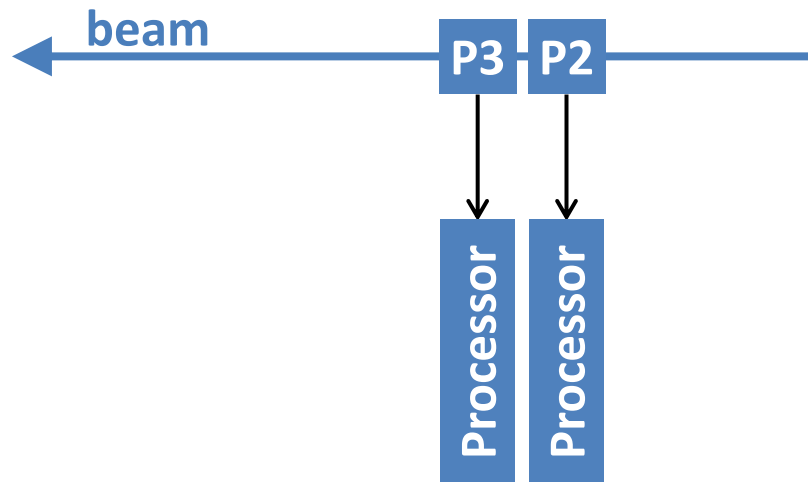

## Processor for stripline BPM

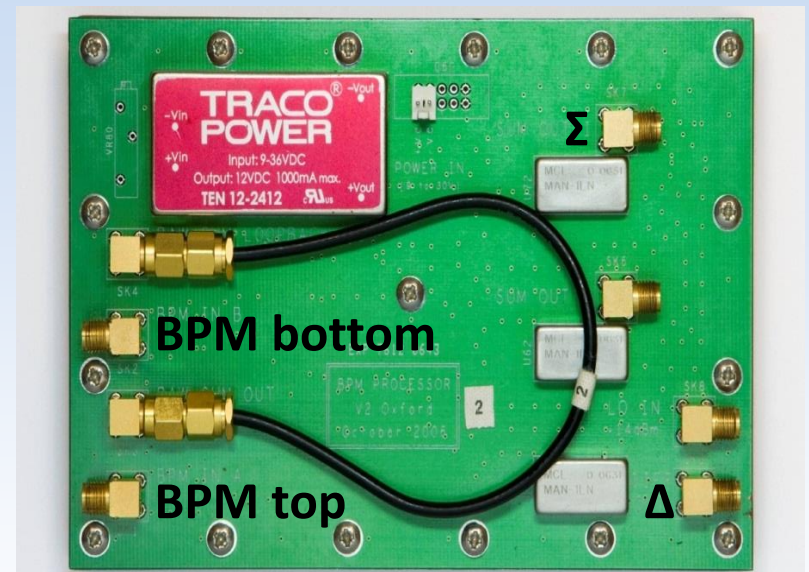

- Analogue: latency 13 ns
- Resolution of 330 nm
- Details in poster TUPME009



# Experimental Setup

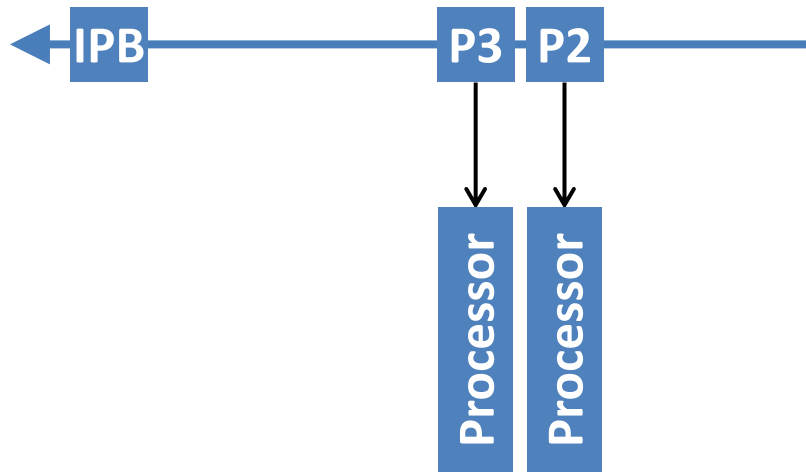

**IPB** Cavity BPM at beam waist

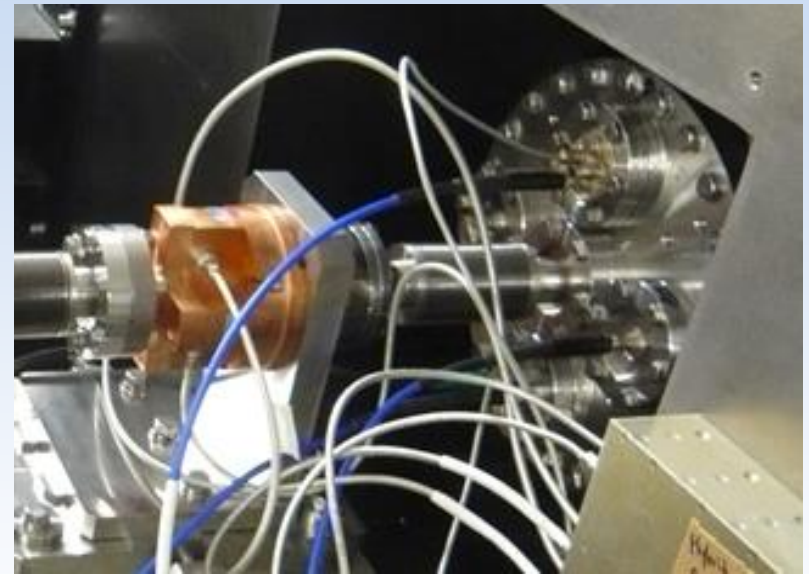

- C-band: 6.4 GHz in  $y$
- Low Q: decay time  $< 30$  ns
- Resolve 2-bunch trains

# Experimental Setup

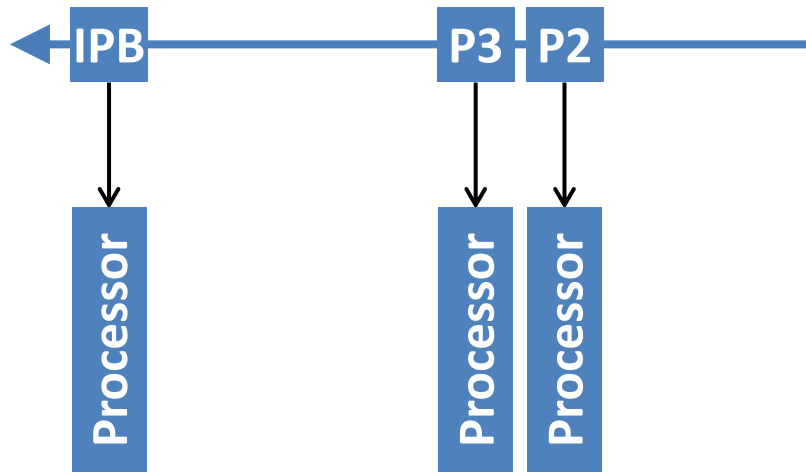

## Processor for cavity BPM

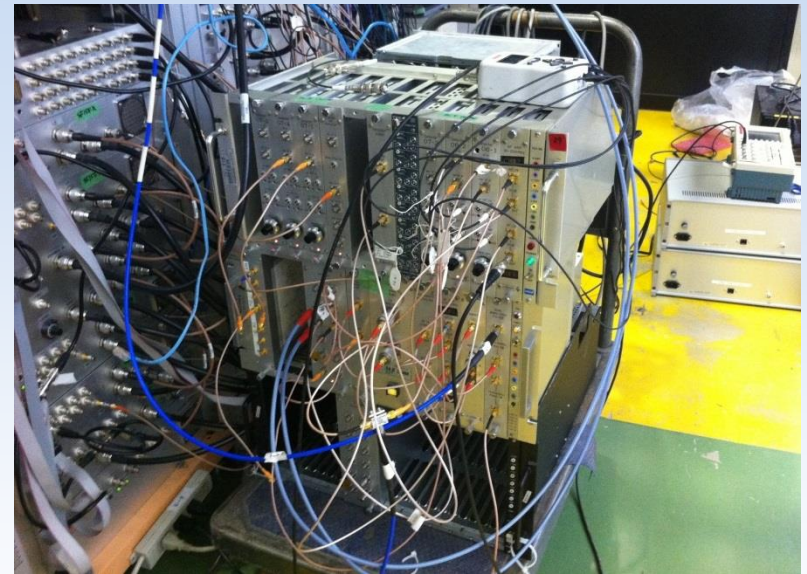

- Analogue, 2-stage downmixer
- Resolution of  $< 100$  nm
- Developed by Honda et al.

# Experimental Setup

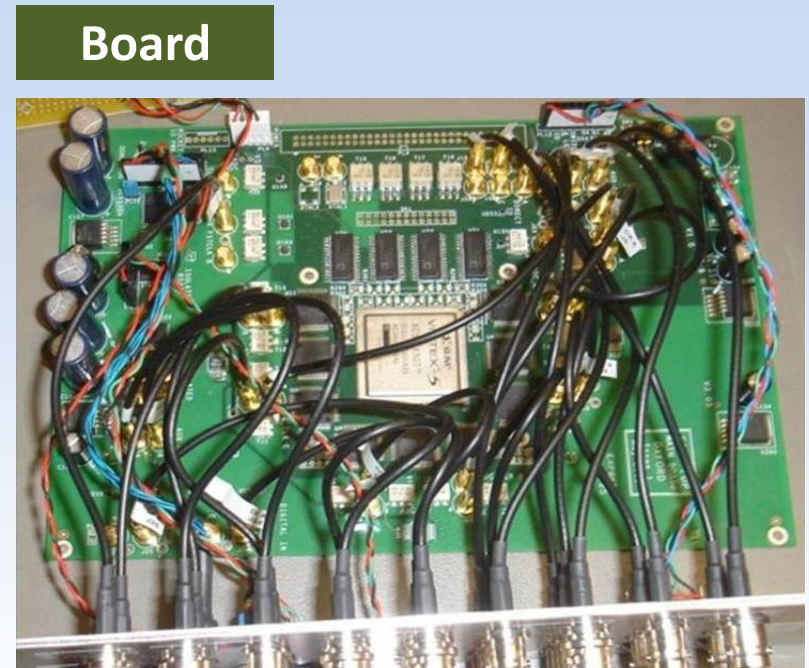
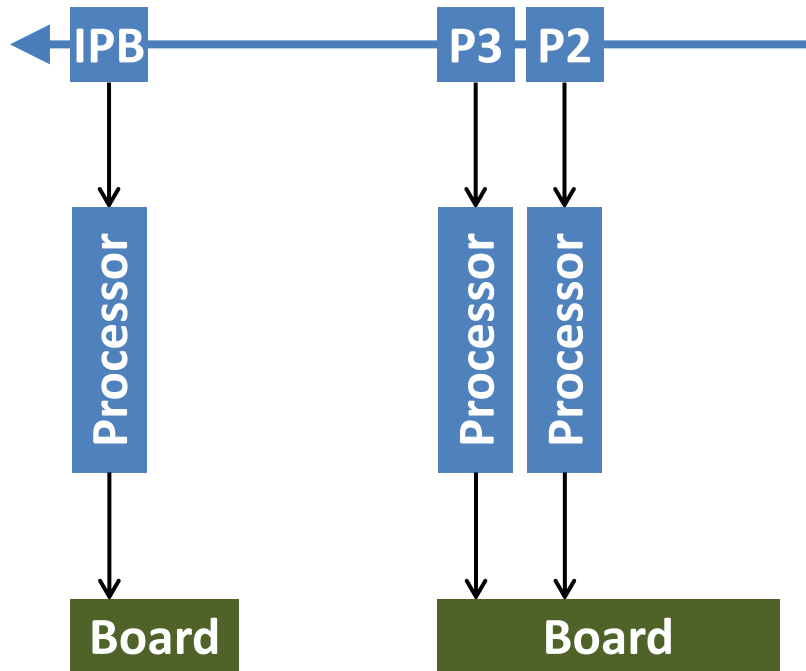

- 9 ADC channels at 357 MHz
- 2 DAC channels at 179 MHz
- Xilinx Virtex 5 FPGA



# Experimental Setup

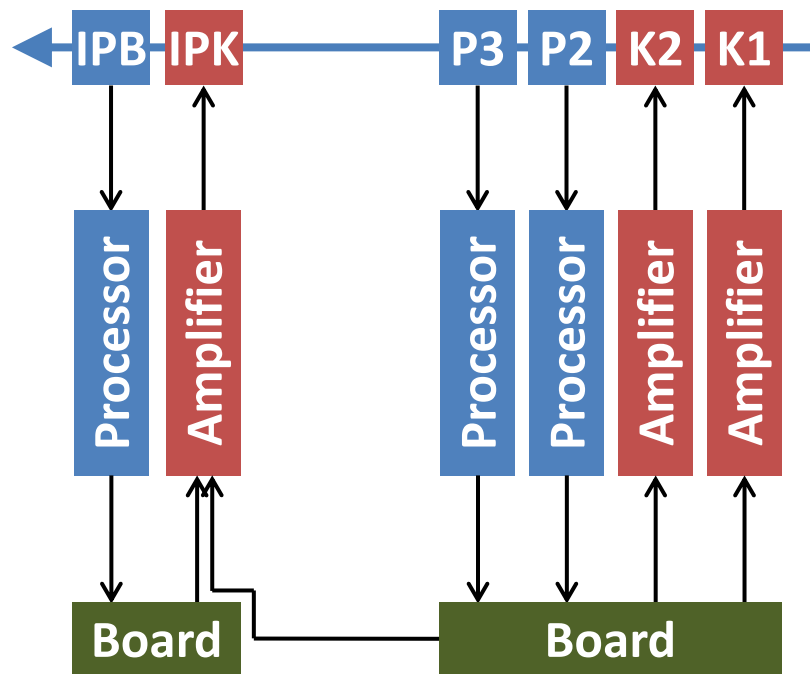

Local upstream feedback results presented in poster TUPME009

## K Kicker

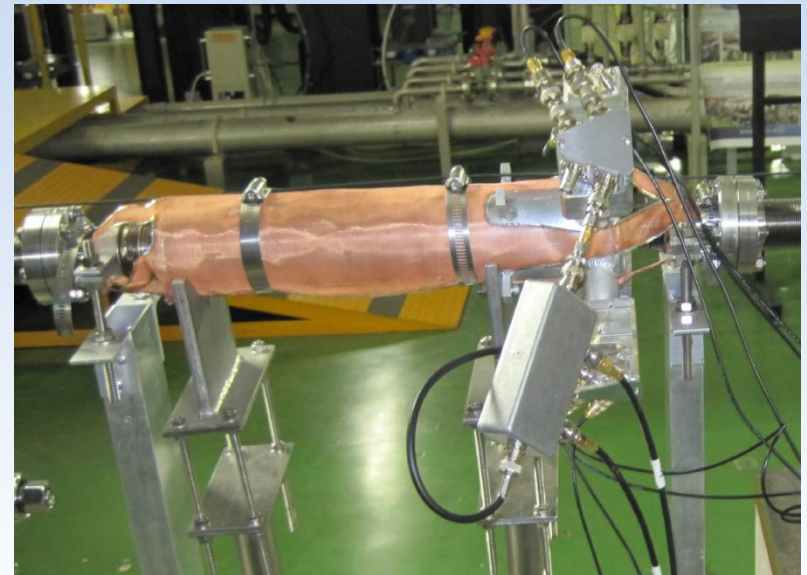

- Vertical stripline kicker
- 30 cm long strips for K1 & K2
- 12.5 cm long strips for IPK

# Cavity BPM Signal Processing

IPB(Y) 6426 MHz

Ref(Y) 6426 MHz

## IPB cavity

Dipole mode frequency (in  $y$ )  
~6426 MHz

## Reference cavity

Monopole mode frequency (in  $y$ )  
~6426 MHz



# Cavity BPM Signal Processing

simplified schematic

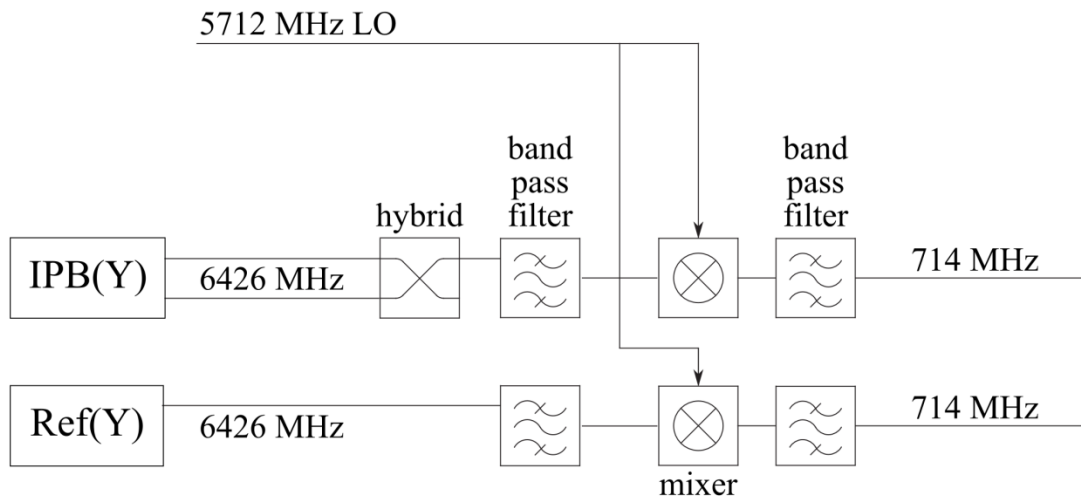

The IPB and reference cavity signals are downmixed using a common, external 5712 MHz local oscillator (LO)

# Cavity BPM Signal Processing

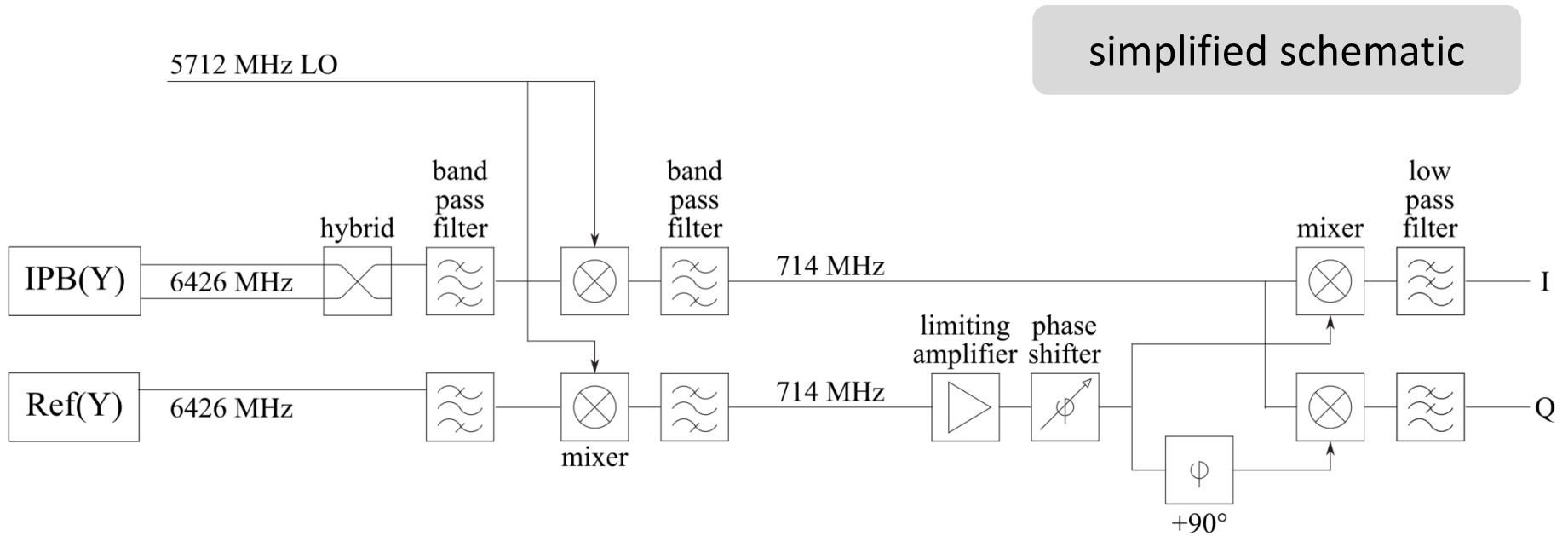

The IPB signal is downmixed using the reference cavity signal as LO  
The I and Q output signals at baseband are used to obtain the beam position



# Feedforward

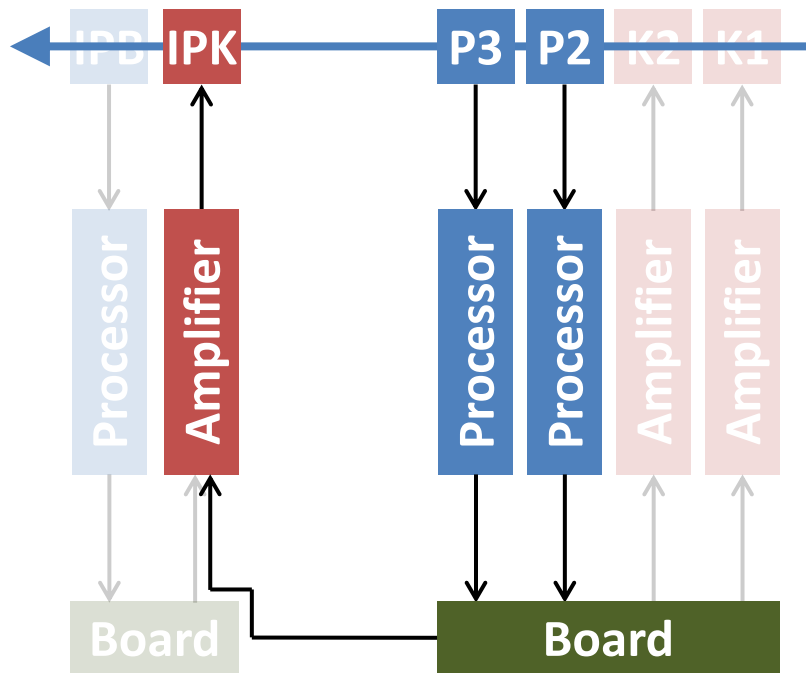

- Use position at P2 & P3 to correct position at IPB
- Correction calculated locally, then sent along 60 meters of cable
- Latency: 202 ns
- Effect measured at IPB

# Feedforward

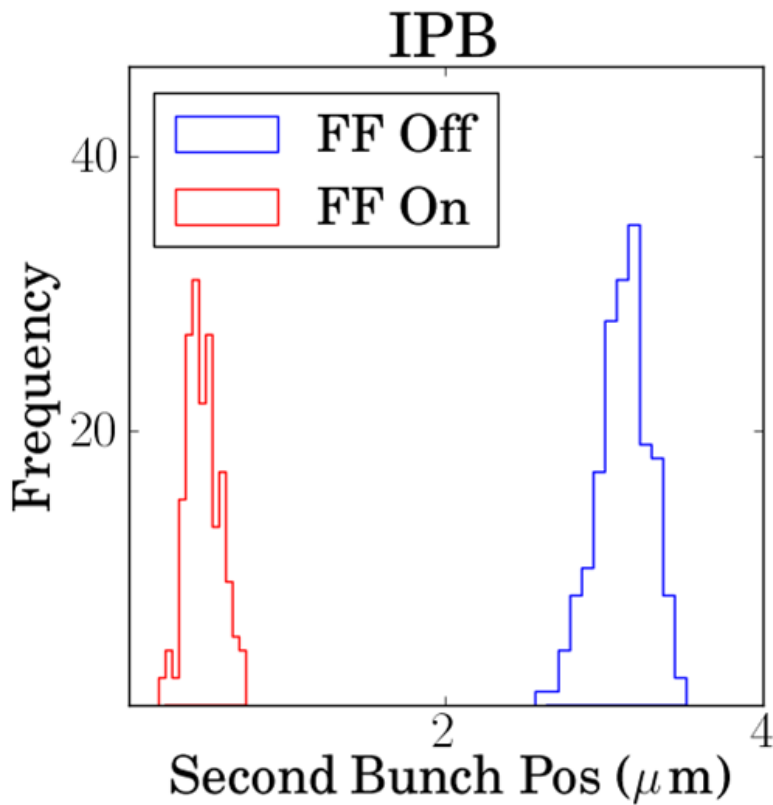

**FF Off Jitter:  $160 \pm 10$  nm**

**FF On Jitter:  $106 \pm 10$  nm**

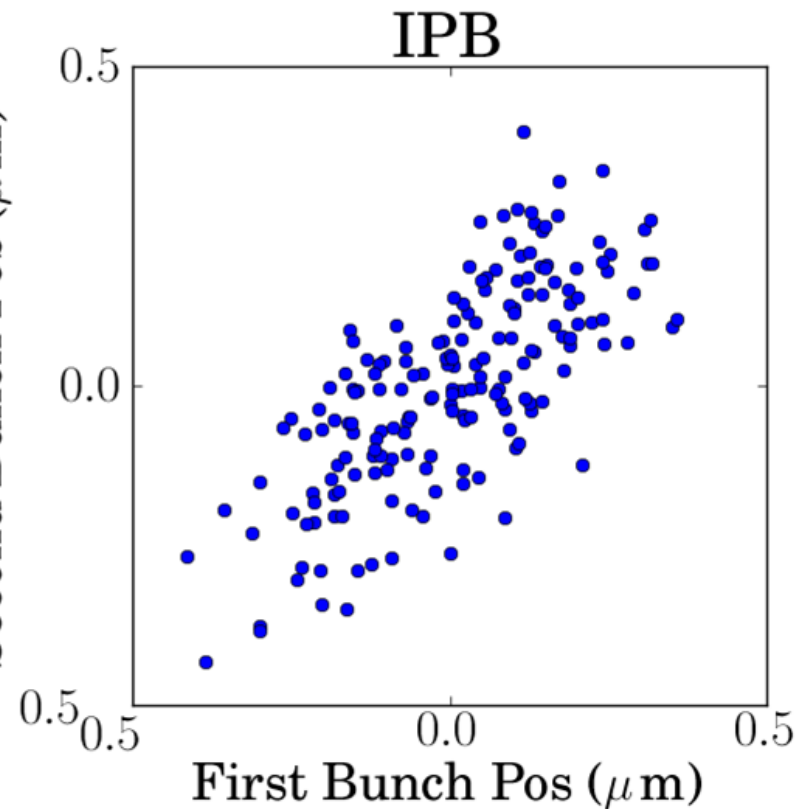

**FF Off Correlation: 73 %**

# Feedforward

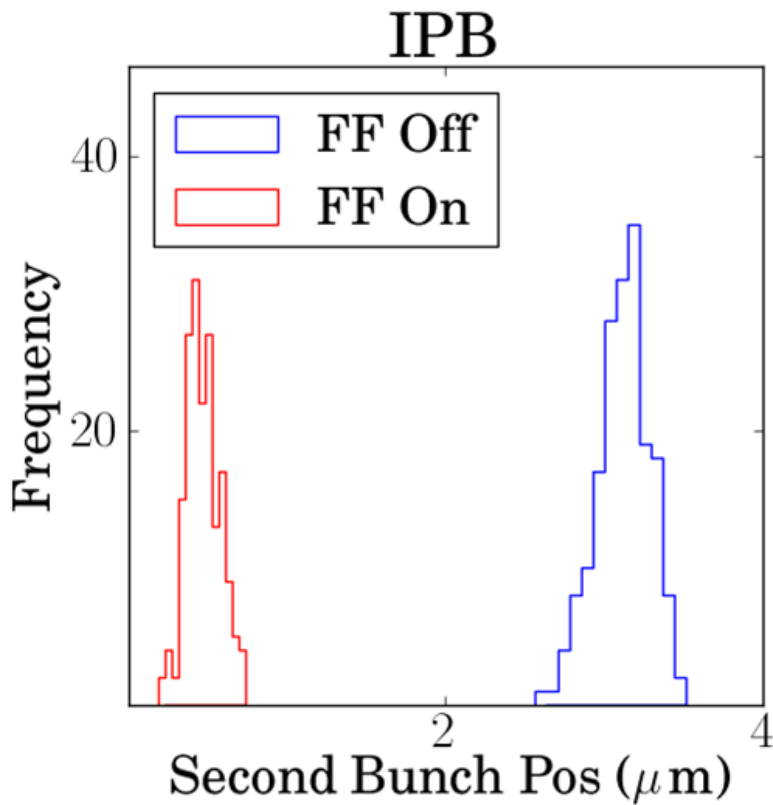

**FF Off Jitter:  $160 \pm 10$  nm**

**FF On Jitter:  $106 \pm 10$  nm**

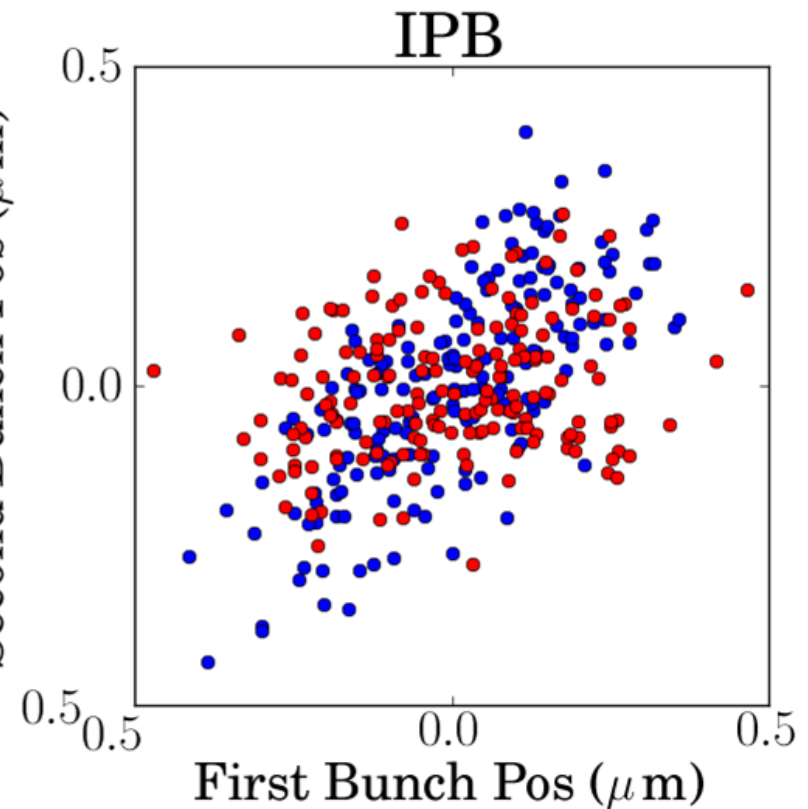

**FF Off Correlation: 73 %**

**FF On Correlation: 23 %**

# Feedforward

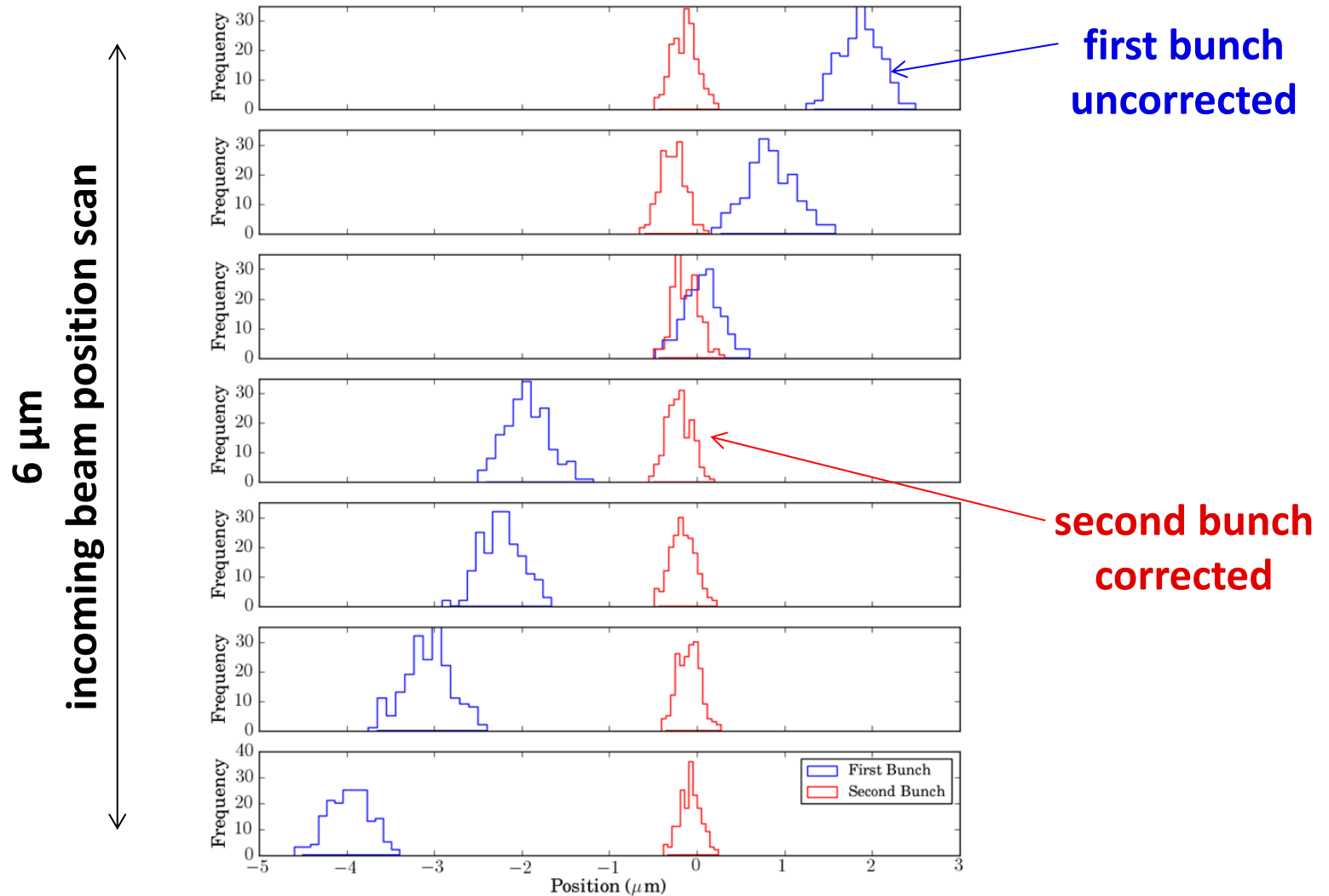

# Interaction Point Feedback

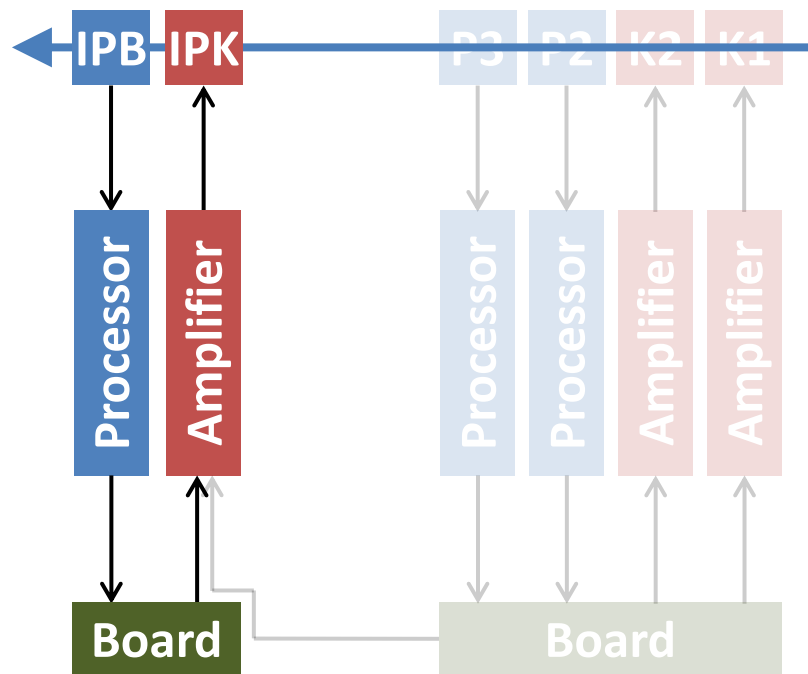

- IPB position is used to drive the local kicker IPK
- Latency: 212 ns
- Effect measured at IPB

# Interaction Point Feedback

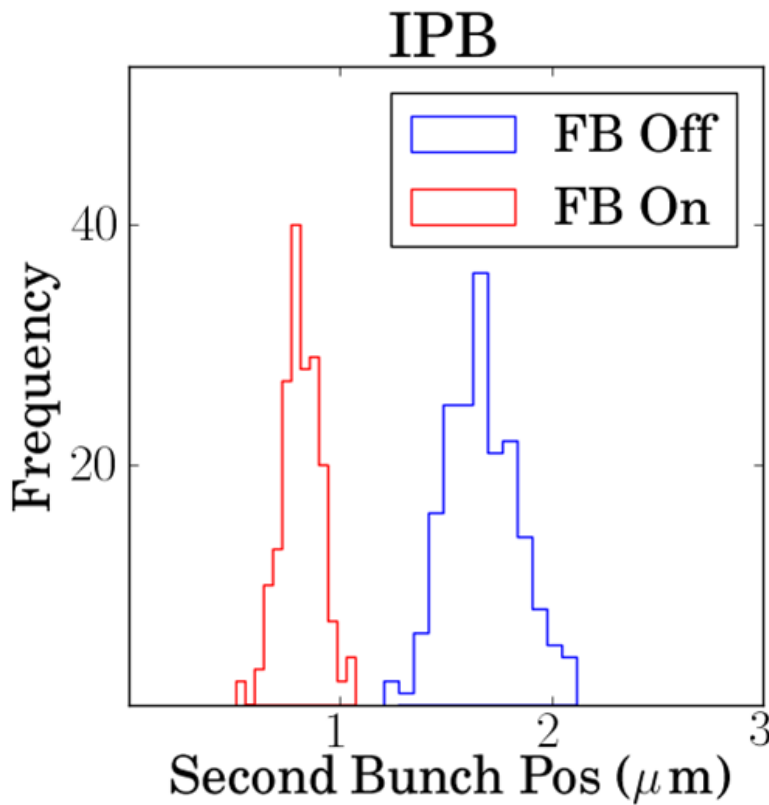

**FB Off Jitter:  $168 \pm 7$  nm**

**FB On Jitter:  $98 \pm 5$  nm**

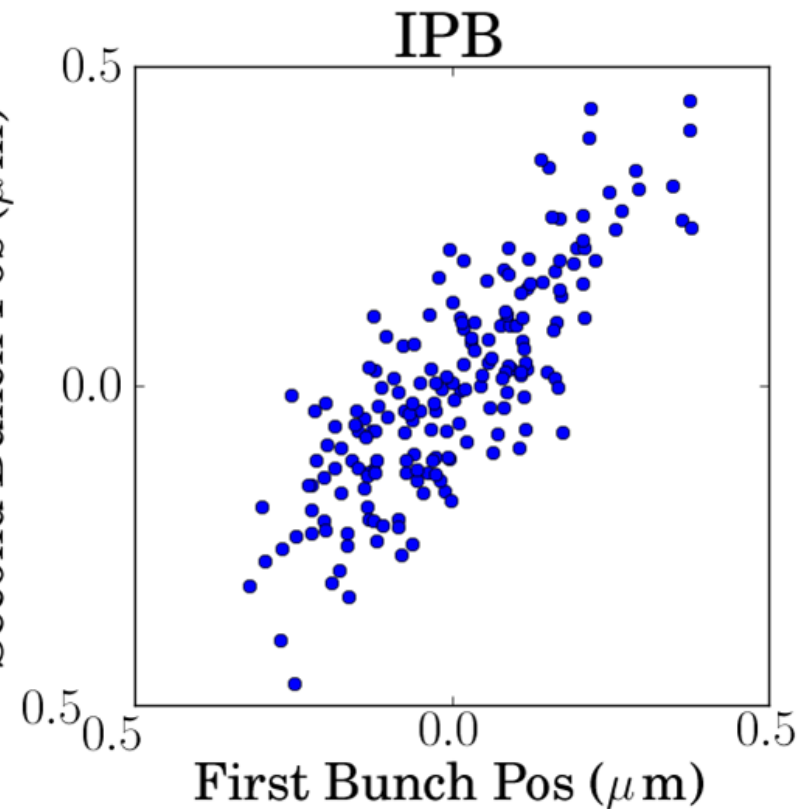

**FB Off Correlation: 81 %**

# Interaction Point Feedback

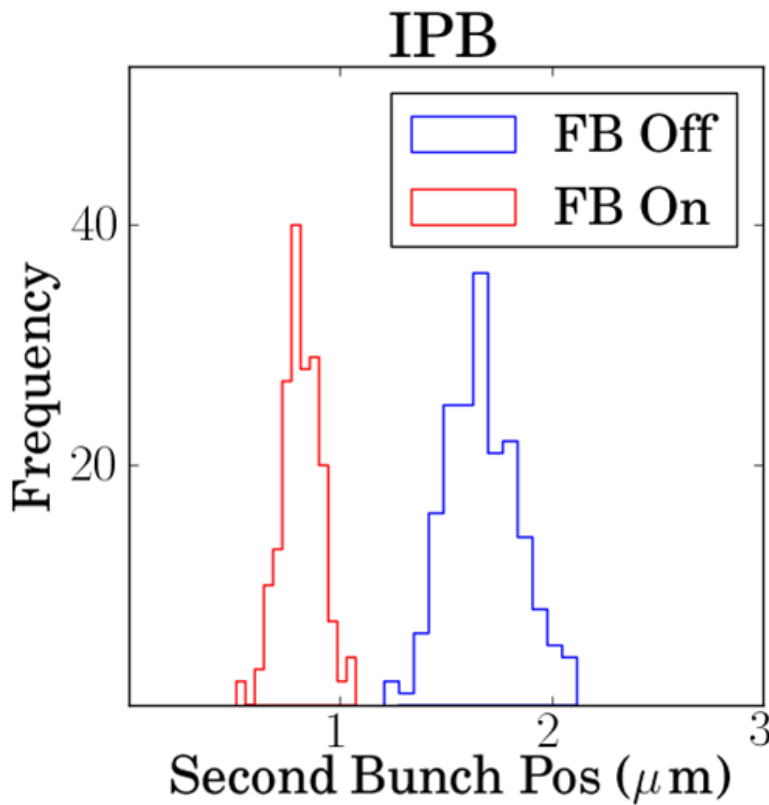

**FB Off Jitter:  $168 \pm 7$  nm**

**FB On Jitter:  $98 \pm 5$  nm**

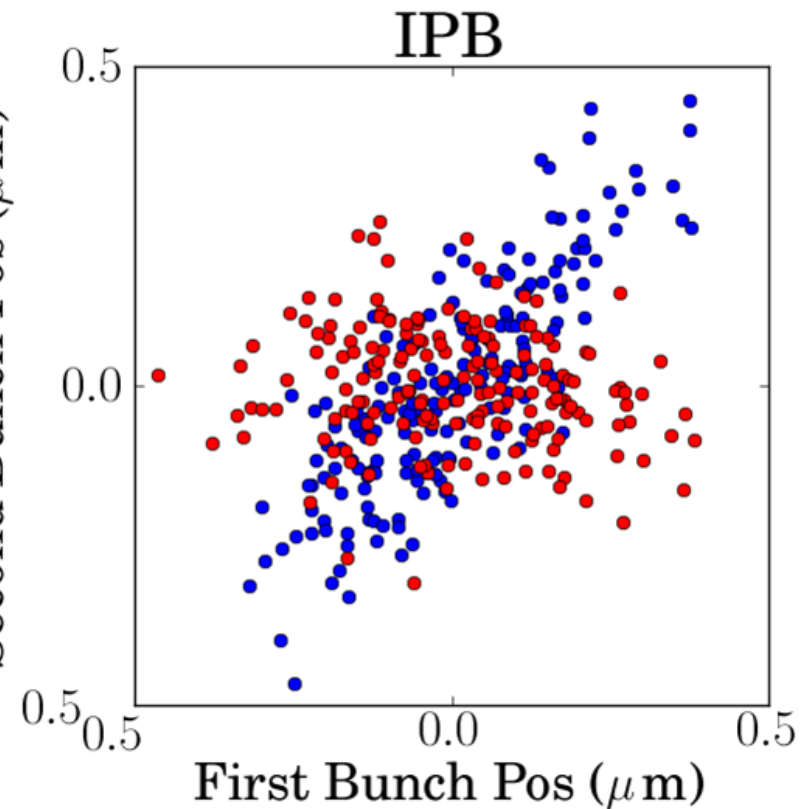

**FB Off Correlation: 81 %**

**FB On Correlation: -16 %**

# Interaction Point Feedback

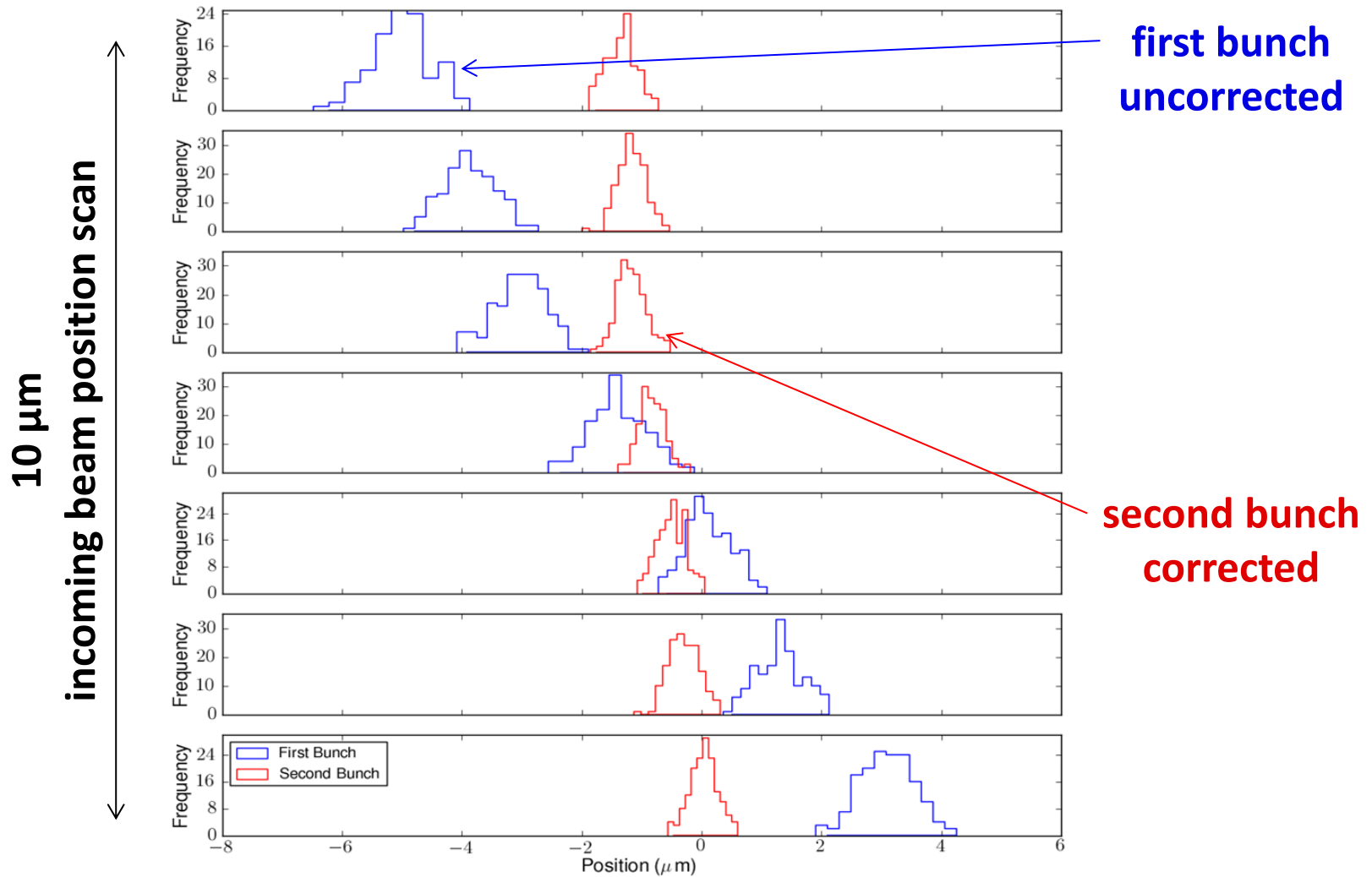



# Conclusion

- Demonstrated low-latency, high-precision, intra-train feedback systems
- Cavity BPM feedback latency: 212 ns
- Achieved beam stabilisation at the ATF IP in 2 modes:
  - Feedforward:  $\sim 100$  nm
  - IP feedback:  $\sim 100$  nm

# Thank you for your attention!

*We thank the ATF collaboration and  
the ATF operations team for their support*