

CONCEPTUAL MAGNETIC DESIGN OF THE LARGE APERTURE D2 DIPOLE FOR LHC UPGRADE*

R. Gupta[#], Brookhaven National Laboratory, Upton, NY 11973, USA

Abstract

CERN has proposed the High Luminosity upgrade of the Large Hadron Collider (HL-LHC). As a part of this proposal, the aperture of the D2 dipole is increased and spacing between the two apertures decreased without increasing the size of cryostat. This creates a significant challenge in keeping the saturation induced harmonics and the flux leakage low, particularly since the field in the two apertures is in the same direction. In addition, small spacing between the two apertures creates significant cross-talk harmonics. The computed field harmonics based on initial designs were rather large and limited the beam dynamics performance of the machine. This paper presents an optimized magnetic design (with much effort made to optimize the yoke) to achieve the desired field quality in the magnets. A table of expected harmonics based on this design is also presented.

INTRODUCTION

Brookhaven National Laboratory (BNL) has designed and built a number of interaction region dipoles [1] as a part of the US contribution to the Large Hadron Collider (LHC). These are based on the 80 mm RHIC dipole coil cross-section [2]. Of particular interest is the twin aperture dipole D2 (see Fig. 1), where the field in the two apertures is in the same direction [3] rather than in the opposite direction, as is more common in 2-in-1 dipoles (such as LHC arc dipoles). This requires more yoke [4], particularly at the midplane, to avoid excessive saturation of the iron. This was obtained with an oblate shape [1], as shown in Fig. 1. The High Luminosity upgrade [5] of the LHC (HL-LHC) requires an even larger aperture for this dipole (105 mm instead of 80 mm). This requirement increased the saturation induced harmonic in early designs based on a conventional yoke. A number of magnetic designs were examined [4], [6] to reduce these harmonics and the one selected is described in detail here.

The normal and skew field harmonics (b_n and a_n) in accelerator magnets are defined in the following expression:

$$B_y + iB_x = 10^{-4} \times B_{R0} \sum_{n=1}^{\infty} (b_n + ia_n) [(x + iy) / R]^{n-1},$$

where B_x and B_y are the components of the field at (x, y) and B_{R0} is the magnitude of the field due to the most dominant harmonic at a “reference radius” R .

*Work supported by the U.S. DOE/OHEP under Contract No. DE-AC02-98CH10886 with the Brookhaven Science Associates, LLC. The HiLumi LHC Design Study is included in the High Luminosity LHC project and is partly funded by the European Commission within the Framework Programme 7 Capacities Specific Programme, Grant Agreement 284404.

[#]Corresponding author: Ramesh Gupta, gupta@bnl.gov.

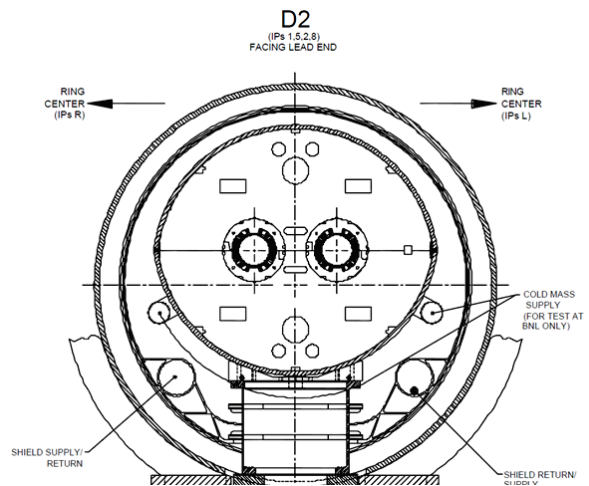

Figure 1: Cross-section of the 80 mm twin aperture D2 dipole that is currently installed in LHC using standard cryostat and support posts. Oblate shaped yoke provides extra iron needed at the midplane.

MAGNET DESIGN OPTIMIZATION

The basic design parameters of this twin aperture D2 dipole are: aperture = 105 mm, inter-beam spacing = 186 mm, and maximum field = 3.5 T (for a magnetic length = 10 m). The biggest challenge in the magnetic design is the large saturation induced harmonics created because of the proximity of the two apertures and the limited space available for the iron yoke, particularly since the field in the two apertures is in the same direction [4]. One way to deal with this is to have the iron far away [7] from the coils at the expense of large fringe fields. During the course of this work, a large number of cross-sections were optimized with the aperture ranging from 90 mm to 105 mm [4], [6], in addition to those that were considered by other groups [7-9].

A selected magnetic design [6] with an optimized yoke to produce small saturation induced harmonics (i.e. small change in field harmonics as a function of current) is discussed in more detail here. Fig. 2 shows a computer model with OPERA2d [10] of one symmetric half (right half) of the design inside the cryostat (only a partial cryostat is shown). The main features of the design are: oblate shaped yoke, iron between the two apertures removed (see left of the coil) but remained circular ($r = 22$ mm) on the other side, and iron shim (placed outside the helium vessel). Parameters used in the magnetic design optimization of this particular class of design are: the shape and size of the inner surface of the yoke (surface closest to coil), the thickness of the iron

shim [11], and the size and the location of various cut-outs in the iron yoke.

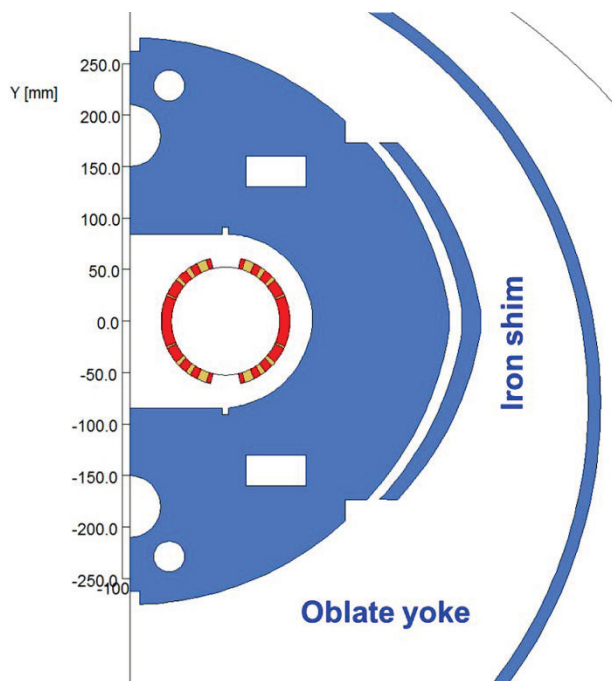

Figure 2: Computer model of a symmetric half (right half) of the optimized magnetic design.

Figure 3 shows the field contour and field lines in the right half of the magnet and Fig. 4, the fringe field outside the cryostat at the design field (3.5 T). One can see (Fig. 3) that all flux from an aperture must return on the same side and thus emphasizes the need for extra iron when the field in the two apertures is in the same direction. One can see (Fig. 4) that the fringe field outside the cryostat remains small (maximum scale is 2 mT).

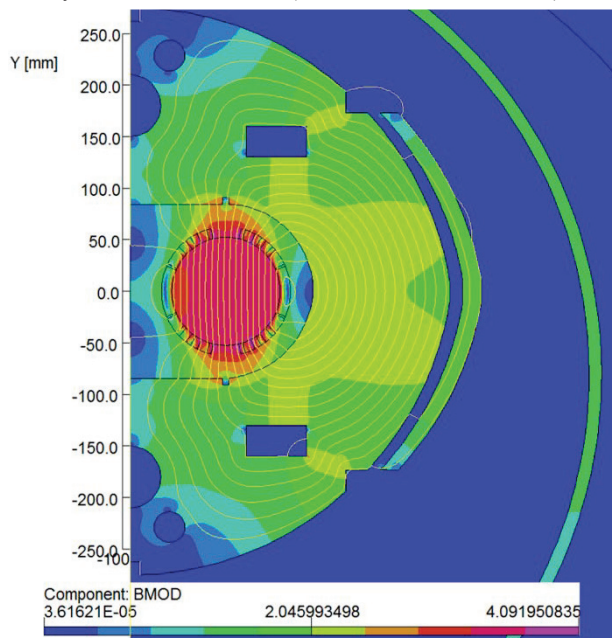

Figure 3: Field contours and field lines at the design field.

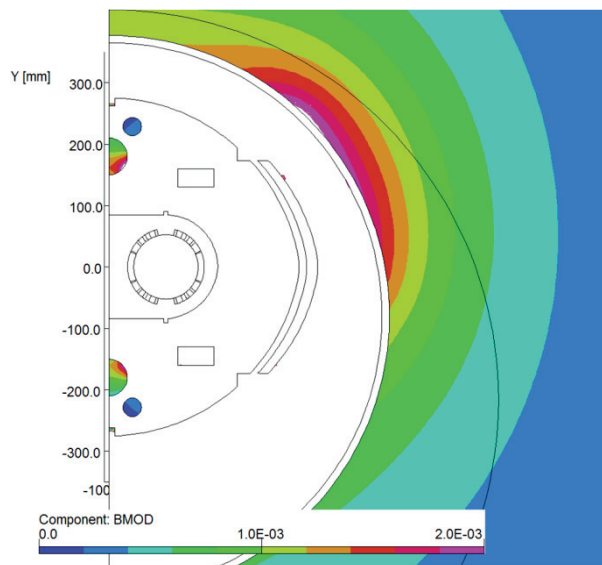

Figure 4: Fringe field outside the cryostat at the design field.

Coil Design

Coil design programs such as ROXIE [12] assume circular iron aperture, which is not the case here. To get overall small harmonics, the coil must be designed with compensating non-zero harmonics [7], [8], [13]. One such design is shown in Fig. 5.

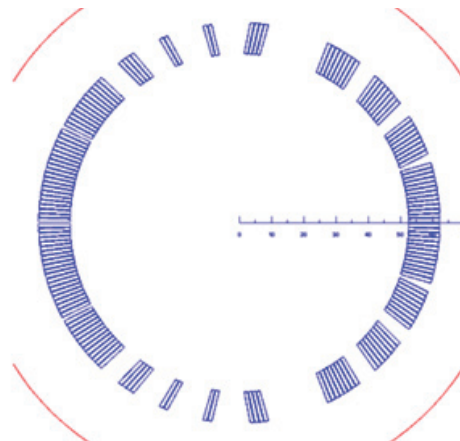

Figure 5: Coil design with ROXIE to compensate the harmonics arising due to a non-circular yoke aperture.

Field Harmonics as a Function of Current

The computed change in transfer function and normal field harmonics (b_n) at 35 mm radius as a function of current for this optimized design are given in Table 1 and plotted in Fig. 6 and Fig. 7. An offset is added to make all of them start from zero at the first (lowest field) entry. The change in transfer function is the relative change expressed in percentage (%).

Based on the above calculations and the expected harmonics table in [9], the expected normal harmonics for this optimized design are given in Table 2. Persistent current induced b_2 , etc. are not estimated and listed.

Table 1: Relative change in transfer function (in percentage) and field harmonics (at 35 mm radius) as a function of field.

B_0	$d(TF)/TF, \%$	b_2	b_3	b_4	b_5	b_6	b_7	b_8
0.89	0.00	0	0	0	0	0	0	0
1.79	-0.03	-0.1	0.06	-0.02	-0.05	0.00	0.01	0.00
2.66	-0.86	-1.7	-0.88	-0.63	-0.70	0.03	0.11	-0.03
3.15	-2.19	-1.3	0.86	-0.61	-1.54	0.14	0.26	-0.06
3.30	-2.82	-2.1	1.31	-0.63	-1.93	0.13	0.31	-0.07
3.45	-3.54	-3.6	1.44	-0.65	-2.31	0.12	0.34	-0.07
3.59	-4.37	-5.7	1.22	-0.55	-2.60	0.11	0.36	-0.08
4.13	-8.24	-18.	-3.19	-0.56	-3.50	0.09	0.38	-0.09

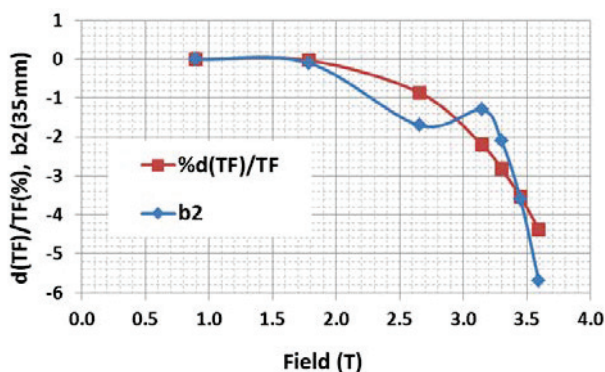

Figure 6: Relative change in transfer function (in percentage) and field harmonics as a function of current.

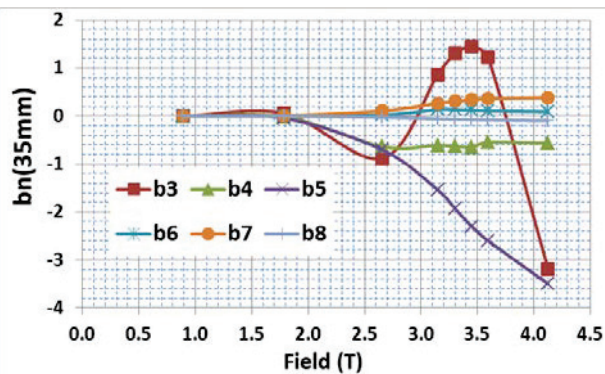

Figure 7: Computed change in field harmonics (b_3 to b_8) as a function of current.

Table 2: The expected “systematic”, “uncertainty” and “random” normal (b_n) harmonics in HL-LHC D2 dipole at a reference radius of 35 mm (updated from Todesco [9]).

b_n $n=$	Systematic					Uncertainty		Random	
	Geom- etric	Satu- ration	Persis- tent	Injec- tion	High Field	Injec- tion	High Field	Injec- tion	High Field
2	6.0	-6	0	6	0	3	3	3	3
3	0	0	-14.2	0	1	2	2	2	2
4	-0.6	0	0	-0.6	0	1	1	1	1
5	3	-3	-1	3	0	2	2	1	1
6	0	0	0	0	0	0.1	0.1	0.1	0.1
7	0	0.4	-0.7	-0.4	0	0.2	0.2	0.2	0.2
8	0	-0.1	0	0.1	0	0.1	0.1	0.1	0.1

CONCLUSION

With special shaping of iron, it is possible to design 105 mm aperture D2 dipole for HL-LHC with the desired field quality and low fringe field outside the yoke despite the field in the two apertures being in the same direction. Expected field errors are now comparable to those that are expected in a typical accelerator magnet.

ACKNOWLEDGMENT

Discussions with M. Anerella from BNL, E. Todesco from CERN, G. Sabbi from LBNL and A. Zlobin from FNAL were useful during the course of this work.

REFERENCES

- [1] E. Willen, et al., “Superconducting Dipole Magnets for the LHC Insertion Regions,” EPAC 2000, Vienna, p 2187 (2000).
- [2] R.C. Gupta, et al., “Coldmass for LHC Dipole Insertion Magnets”, Presented at the Fifteenth International Conference on Magnet Technology (MT-15) at Beijing, China (1997).
- [3] A. Jain, et al., “Field Quality in the Twin Aperture D2 Dipole for LHC Under Asymmetric Excitation,” Particle Accelerator Conference, New York, (1999).
- [4] R. Gupta, “Design of D2,” Joint LARP CM20/HiLumi Meeting, Napa Valley, CA, Apr 8-10, 2013, <https://indico.fnal.gov/conferenceDisplay.py?confId=6164>.
- [5] E. Todesco, et al., “A First Baseline for the Magnets in the High Luminosity LHC Insertion Regions,” MT-23, IEEE Trans. Appl. Supercond. 24 (2014).
- [6] R. Gupta, “D2 conceptual design and field quality optimization,” 3rd Joint HiLumi LHC-LARP Annual Meeting, at Daresbury Laboratory, Nov. 11-15, 2013, <https://indico.cern.ch/event/257368>.
- [7] V. Kashikhin, A. Zlobin, “Design Study of a 2-in-1 Large-aperture IR Dipole (D2) for the LHC Luminosity Upgrade,” PAC07, p464 (2007).
- [8] G. Sabbi and X. Wang, “D2 Conceptual Design, Status and Next Steps”, 3rd Joint HiLumi LHC-LARP Annual Meeting, at Daresbury Laboratory, Nov. 13, 2013, <https://indico.cern.ch/event/257368>.
- [9] E. Todesco, “Magnet Status and Open Issues,” 3rd Joint HiLumi LHC-LARP Annual Meeting, at Daresbury Laboratory, Nov. 11-15, 2013, <https://indico.cern.ch/event/257368>.
- [10] <http://cobham.vectorfields.com/>.
- [11] R. Gupta, et al., “Iron Shims Outside the Helium Vessel to Adjust Field Quality at High Fields,” WEPRI101, Proc. IPAC2014, <http://jacow.org/>.
- [12] S. Russenschuck, “A Computer Program for the Design of Superconducting Accelerator Magnets”, CERN AT/95-39, LHC Note 354, Sept. 26, 1995.
- [13] R. Gupta, et al., “Large Aperture Quadrupoles for RHIC Interaction Regions,” Proc. 1993 Particle Accelerator Conference, Washington, D.C., pp. 2745-2747 (1993).