

DESIGN OF A MULTI-HARMONIC BUNCHER FOR LINCE*

Cristian Bontoiu[†], Jose Antonio Duenas, Juan Labrador, Ismael Martel, Univ. of Huelva, Spain
 Alberto Garbayo, Miguel Angel Carrera, AVS, Elgoibar, Spain
 Antonio Carlos Camargo Villari, FRIB, East Lansing, Michigan, USA

Abstract

Continuous beams delivered by the LINCE [1] ECR ions source will be bunched by a multi-harmonic buncher in order to be injected into an RFQ. Its numerical design is reported along with electric field maps and beam dynamics studies carried out with the codes TRACK [2] and GPT [3]. First experiments with multi-harmonic bunchers were carried out in 1970s at Argonne National Lab. (ANL) [4] and it is used in the design of modern accelerator facilities e.g FRIB and Spiral 2.

INTRODUCTION

A two-electrodes buncher has been designed following past developments at ANL. It has a 7 mm bore radius and a 8 mm gap between the two electrodes. The layout is shown in Fig. 1.

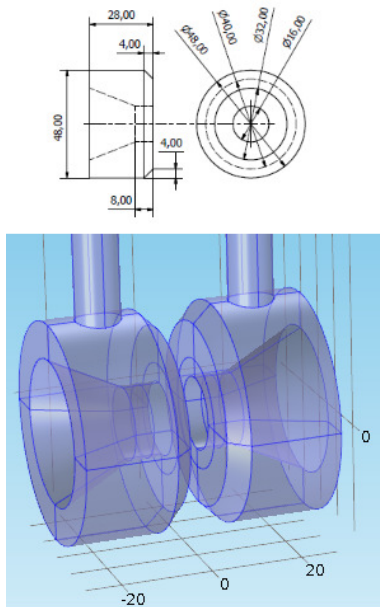

Figure 1: Layout of the buncher consisting of two electrodes fixed by vertical stems.

The buncher fundamental frequency is set at 18.1872 MHz (LINCE fundamental frequency) and mixed with the next three harmonics. An initial electrostatic study produces a three-dimensional electric field map which is then modulated at the four frequencies to provide a sawtooth signal through which the continuous beam eventually exhibits. Multi-frequency operation has been

proven by tracking the required continuous beams of LINCE through a superposition of electric field maps, using TRACK. For $A/Q = 7$ ions of 40 keV/u and applied voltage of 10 kV, bunches of 2 ns length are recorded at the RFQ entrance.

HARMONICS SUPERPOSITION

The ideal bunching waveform is one that gives the ion energy gain

$$\delta E(t) = E_0 \left[\left(1 - \frac{t}{\tau} \right)^{-2} - 1 \right], \quad t \in [0, T] \quad (1)$$

where E_0 is the energy of the ion entering the buncher, τ is the transit time required for an ion of this energy to travel from the buncher to the position of the time focus and t is the time at which an ion arrives at the buncher. Eq. 1 is true over a period T of the signal frequency f assuming that the transit time through the buncher is negligible. It is impossible to apply the ideal energy modulations and bunchers usually make use of sin-wave excitations. A perfect saw-tooth signal can be obtained overlapping an infinite number of sine harmonics but in practice approximations can be made with only a few of them. For example using a four harmonics [5] combination defined as

$$\delta E = \delta E_0 [\sin(\omega t) - 0.40 \sin(2\omega t) + 0.18 \sin(3\omega t) - 0.06 \sin(4\omega t)] \quad (2)$$

produces the signal shown in Fig. 2 with δE_0 being the maximum energy gain of the fundamental harmonic and $-180 \text{ deg} \leq \omega t \leq 180 \text{ deg}$.

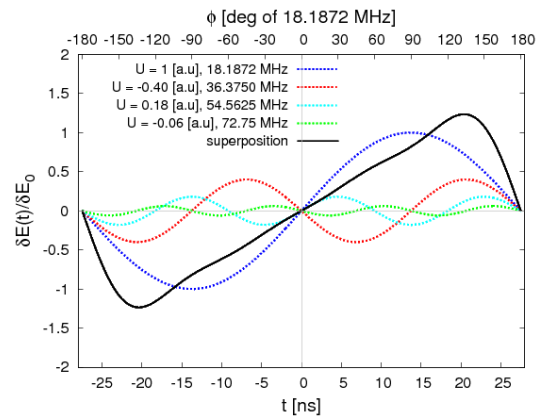

Figure 2: Sawtooth-like waveform obtained as a superposition of four harmonics.

* Work partially supported by the Spanish Government (MINECO-CDTI) under program FEDER INTERCONNECTA.

[†] cbontoiu@gmail.com

ELECTROSTATIC STUDY

An electrostatic study has been performed using Comsol ACDC [6]. Electric potential lines are shown in Fig. 3 for an applied potential difference of 1 kV between the electrodes.

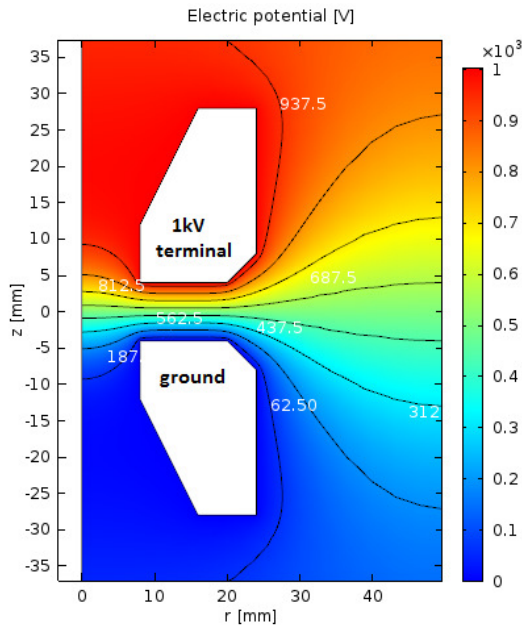

Figure 3: Electric potential lines in an axial cut plane along the buncher. The beam travels at $r = 0$.

Electric field intensity is highest between the electrodes faces but there is useful electric field in the beam region as it can be seen in Fig. 4.

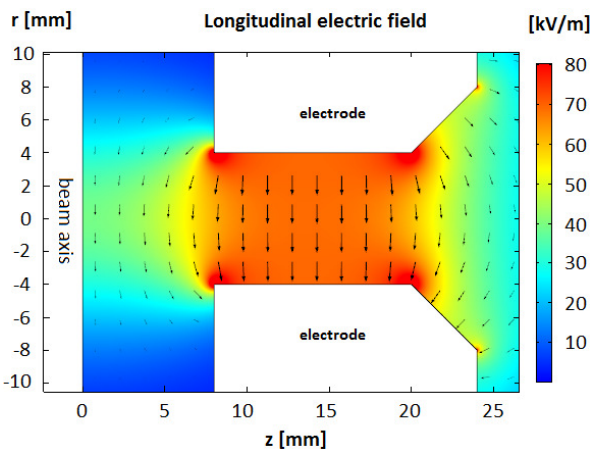

Figure 4: Electric field pattern between the electrodes and in the beam area as seen from an axial cut plane along the buncher.

The longitudinal electric field has a sharp peak along the beam axis and reverses the sign at some distance from the centre of the buncher as shown in Fig. 5. This figure also shows that the longitudinal field is varies strongly from the beam axis to the edge of the buncher in the radial direction.

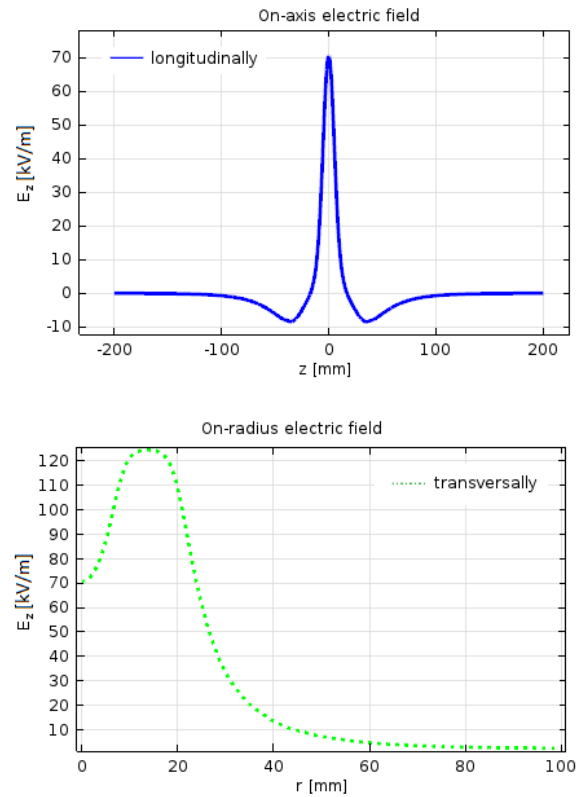

Figure 5: Longitudinal electric field along the beam axis (top) and along the normal to it at $z = 0$ (bottom).

BEAM DYNAMICS

The major part of the beam dynamics studies have been carried out with the TRACK [2] code using the range $A/Q = 1-7$ beam at the design energy 40 keV/u. The input beam has an inherent divergence and needs to be focused into the buncher such that it experiences its central fields which are the most suitable for bunching. If the beam size is large when it crosses the buncher, particles will acquire a variable energy spread according to their radial position. The results are shown in Fig. 6 and in Table 1.

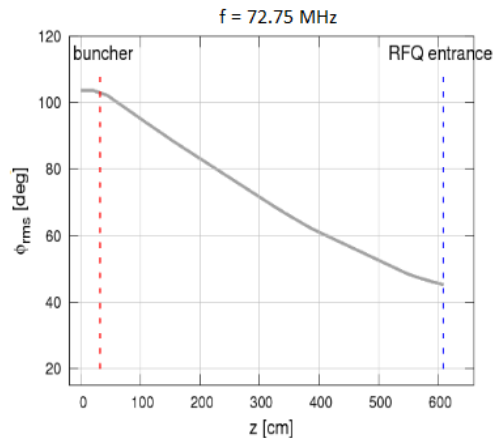

Figure 6: RMS bunch length for $A/Q = 7$ ions travelling between the buncher and the entrance of the the RFQ.

Content from this work may be used under the terms of the CC BY 3.0 licence (© 2014). Any distribution of this work must maintain attribution to the author(s), title of the work, publisher, and DOI.

Table 1: Beam Parameters for $A/Q = 7$ Ions at the Entrance into the RFQ.

Parameter	Value
σ_{\perp} [cm]	0.2219
$\bar{\varepsilon}_{\perp}$ [cm-mrad]	0.0806
$\sigma_{E_{kin}}/E_{kin}$ [%]	1.181
$\Delta\phi^{rms}$ [deg]	45.25
$\bar{\varepsilon}_{\parallel}$ [ns-keV/u]	12.41
\bar{E}_{kin} [keV/u]	40.00

Several test studies have been also performed using the GPT code. Particle trajectories are shown for a test beam in Fig.7 (top). The numerically obtained electric field map has been modulated at the first four harmonics of 18.1872 MHz. The frequency amplitude scaling followed eq. 2 with a variable maximum electric field for the fundamental frequency. An example of bunching is shown in Fig.7 (bottom) where the fundamental frequency signal map was scaled to an equivalent potential difference of 1.5 kV between the electrodes.

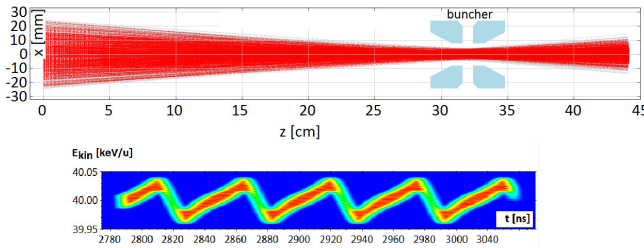

Figure 7: Beam focusing at the centre of the buncher placed at $z = 32$ cm (top). Bunching effect for $A/Q = 7$ ions shown in the time-energy phase space (bottom).

CONCLUSIONS

The article presented results of a complete study of the LINCE buncher using realistic ion beams and electromagnetic fields. The performance has been optimized using the TRACK code through iterative particle tracking studies. A numerical electrostatic study has been performed using Comsol. Future developments of the buncher model shall include the construction of a prototype and testing with real beams.

REFERENCES

- [1] I. Martel et al., "LINCE: A High Intensity Multi-ion Superconducting Linac for Nuclear Structure and Reactions", IPAC'14, Dresden, Germany, June 2014, THPME036, These Proceedings.
- [2] V. Aseev et al., "TRACK: The new beam dynamics code", PAC'05, Knoxville, USA, TPAT028 (2005).
- [3] General Particle Tracer website: <http://www.pulsar.nl/gpt>
- [4] Ostroumov P. et al., "Beam test of a grid-less multi-harmonic buncher", PAC'07, Albuquerque, USA, WEPMN091 (2007).
- [5] F. Lynch et al., Nuclear Instruments and Methods, 159(23):245 – 263, (1979).
- [6] Comsol website: <http://www.comsol.com/products/multiphysics/>