

IMPLEMENTATION OF AN INTENSITY FEEDBACK LOOP FOR AN ION THERAPY SYNCHROTRON



Christian Schömers
PhD student, HIT

2011/09/08
IPAC'11 San Sebastian

Outline

- Introduction
- Extraction without feedback loop
- Feedback loop design
- Constant spill
- Intensity modulated spill
- Summary and Outlook

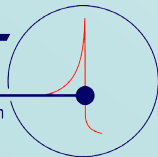

HIT - Heidelberg Ion Therapy facility

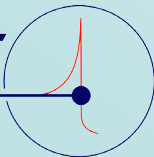
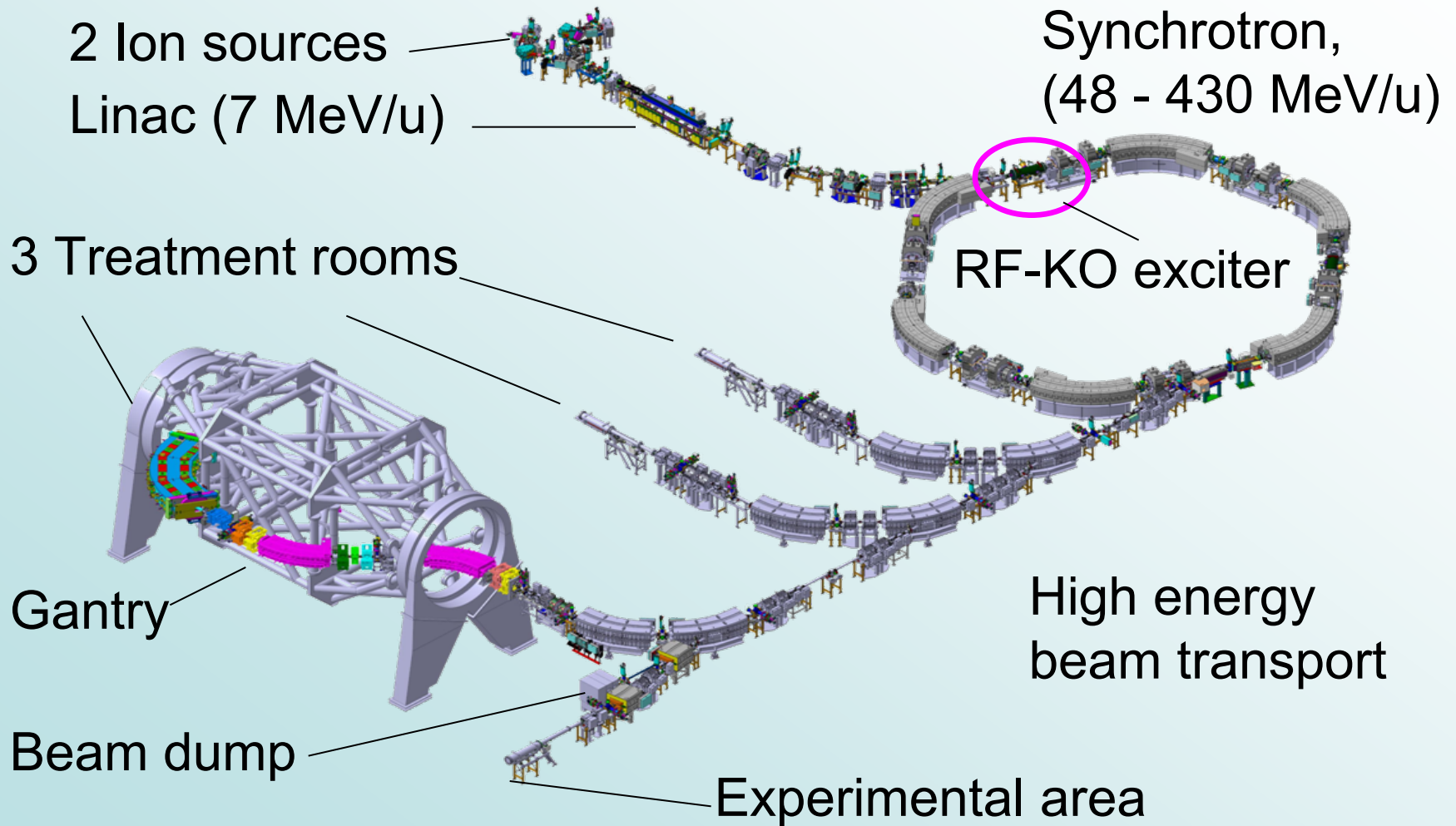

Raster scanning and requirements

- Tumour is irradiated 'slice by slice'
- Beam 'scans' each slice in raster points

→ Slow extraction is needed

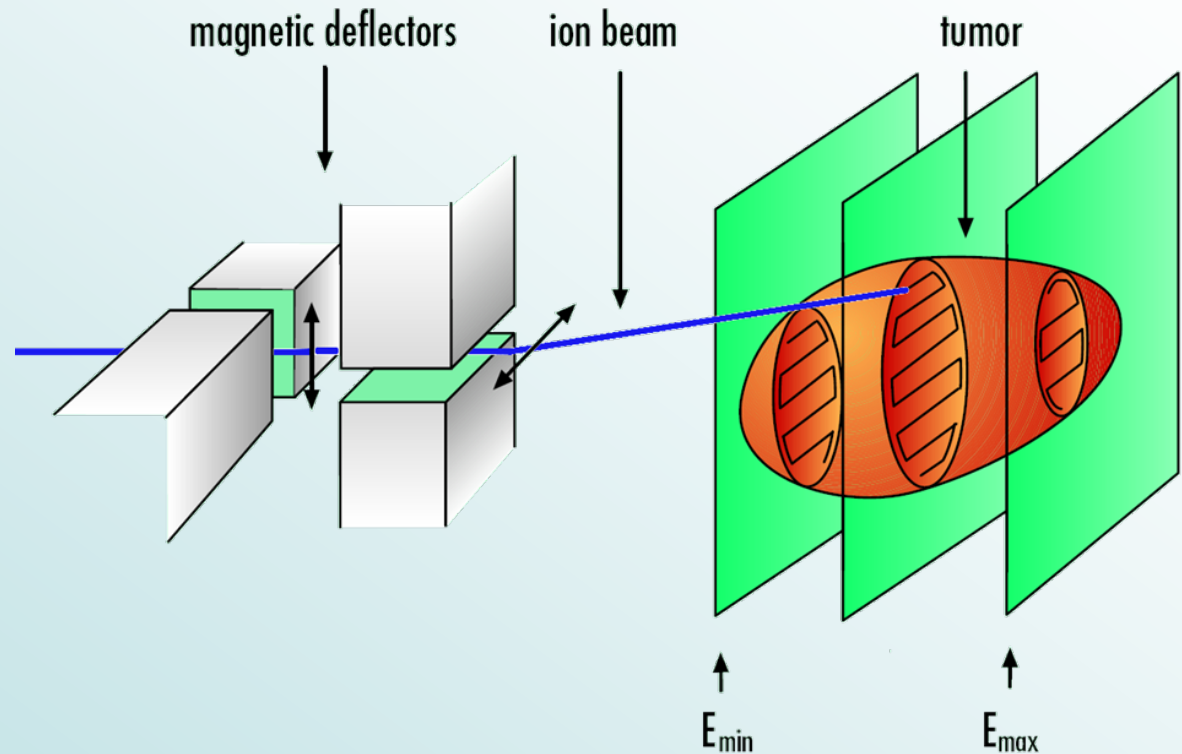

Third order resonant extraction

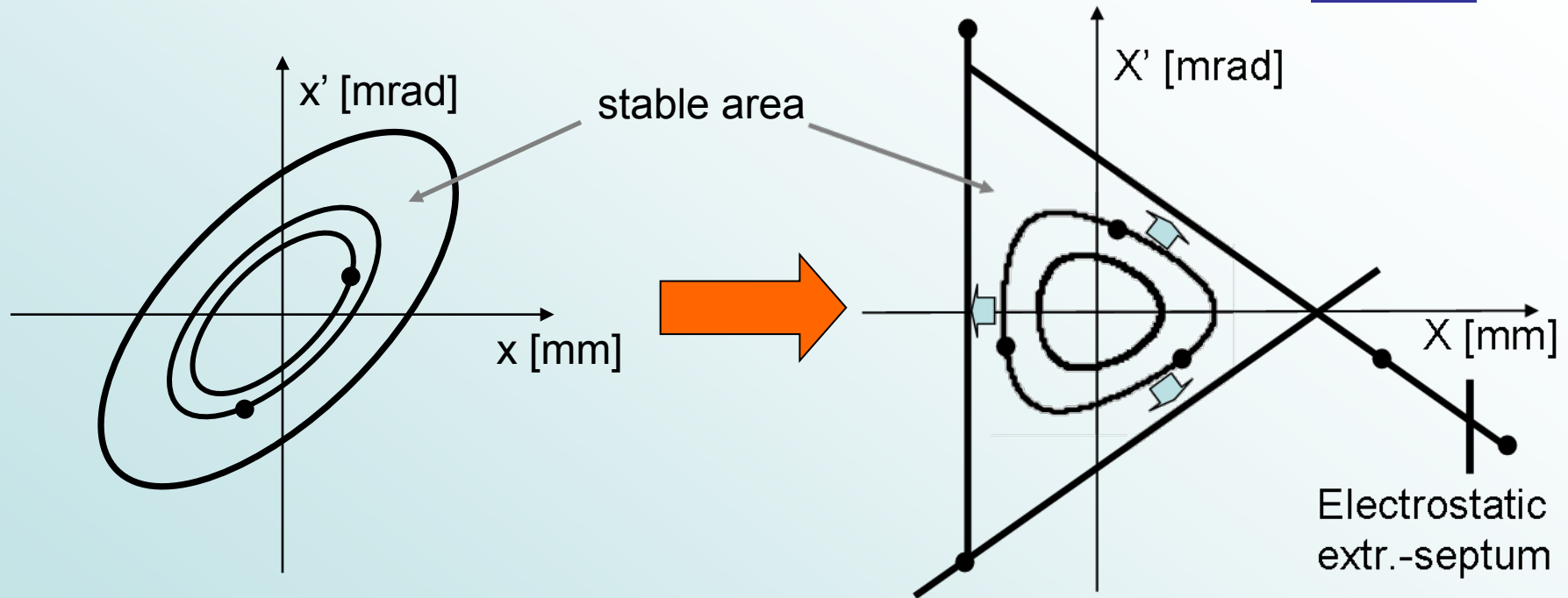

- Quadrupoles excite a third order resonance
- Stable phase space ellipse turns into separatrix under the influence of sextupoles
- Beam is blown up by transverse RF knockout exciter

Present spill shape

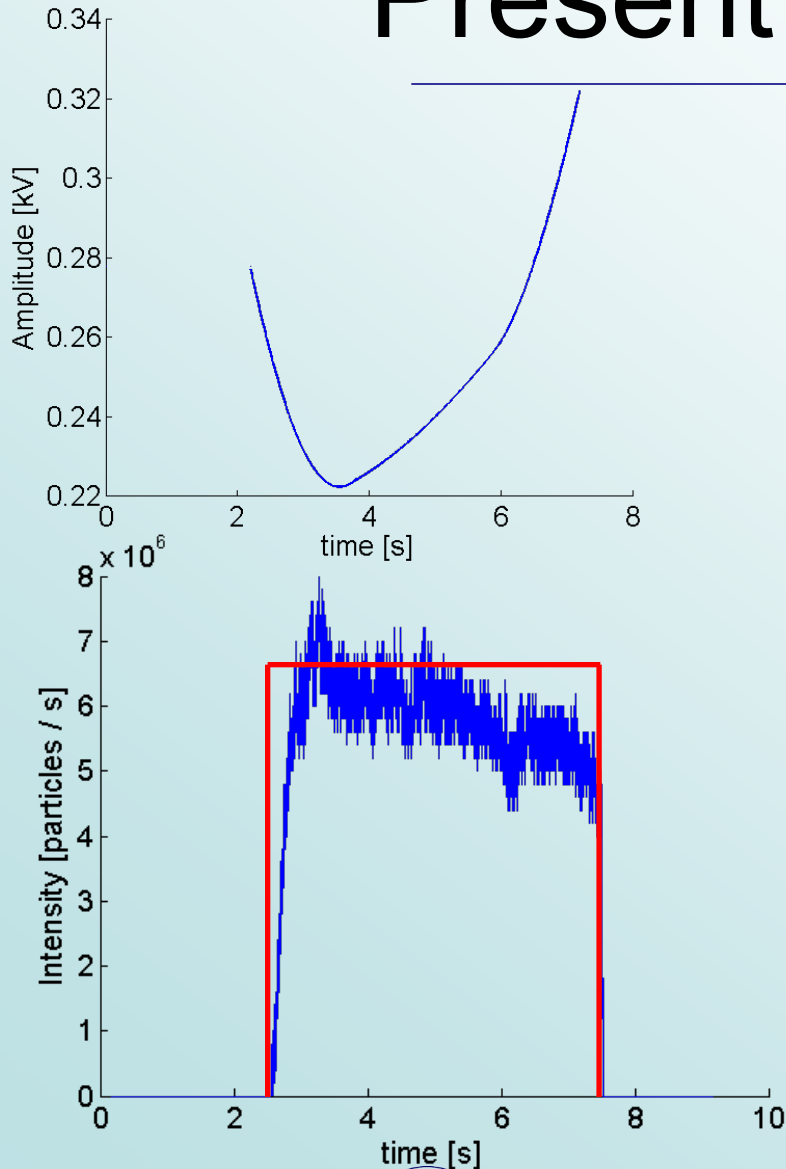

- Predefined amplitude of RF-KO exciter mainly determines spill shape
- But:
 - Inhomogeneous particle distribution
 - Varying injection pulses
 - Sensitive to changes of other synchrotron settings

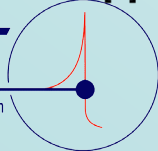

Spill control: rectangular spill

- Less beam-on time, reduction up to 25% !
 - More comfort for patient
 - Available for more patients
 - Economic facility operation
- Less adjustment time

→ **More patients**

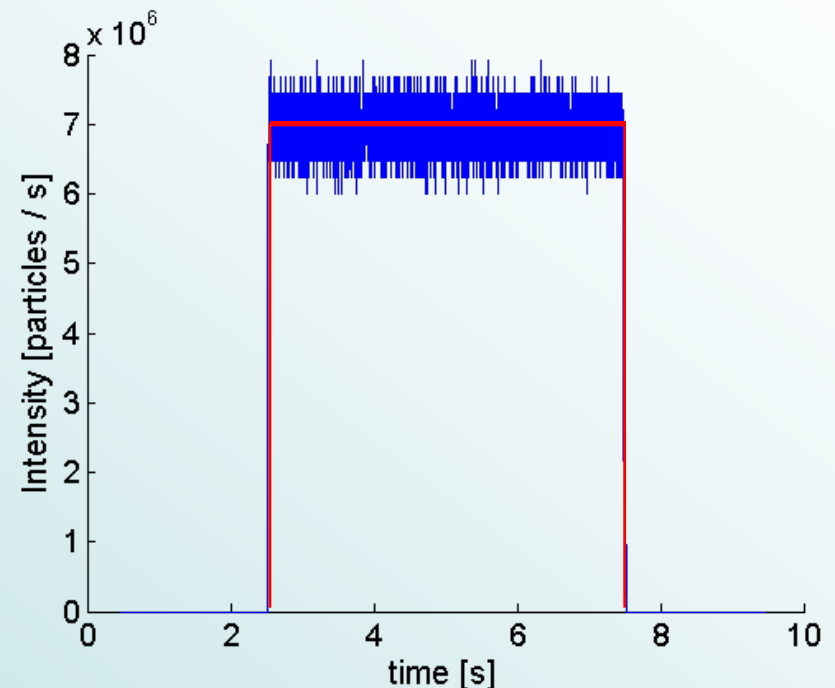

Advances of spill control

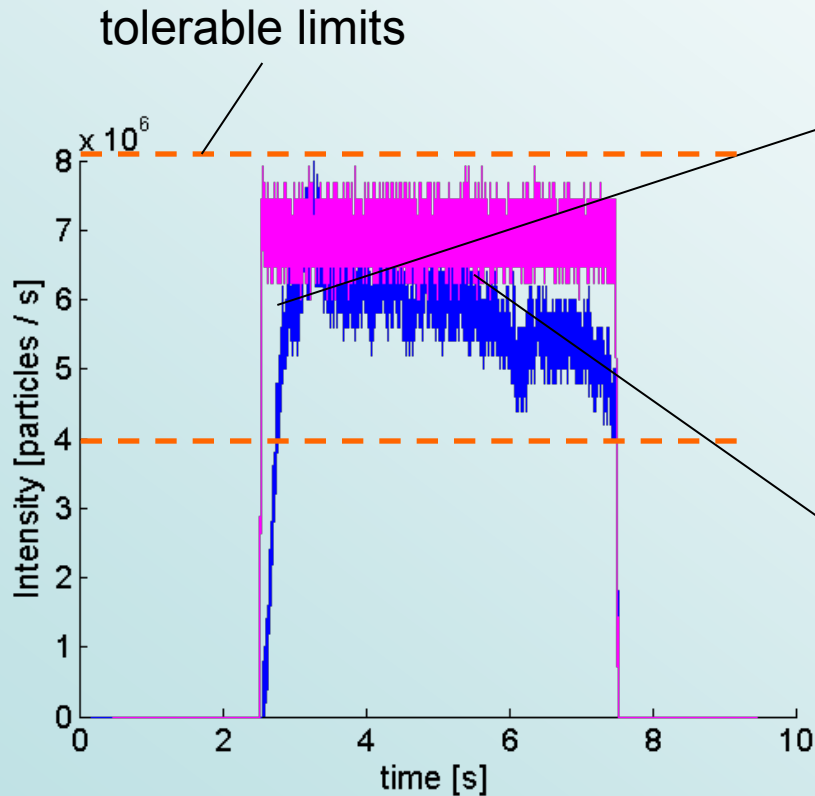

- Effect 1:
 - Fast rise time (some ms compared to some 10ms or 100ms)
 - Significant, often full spill is not needed
- Effect 2:
 - Flat spill can be tuned to upper limit without producing interlocks

Dose distribution

- Dose variation per raster point of factor 100 and more
- Simulation: beam-on time can be reduced by 50% compared to flat spill

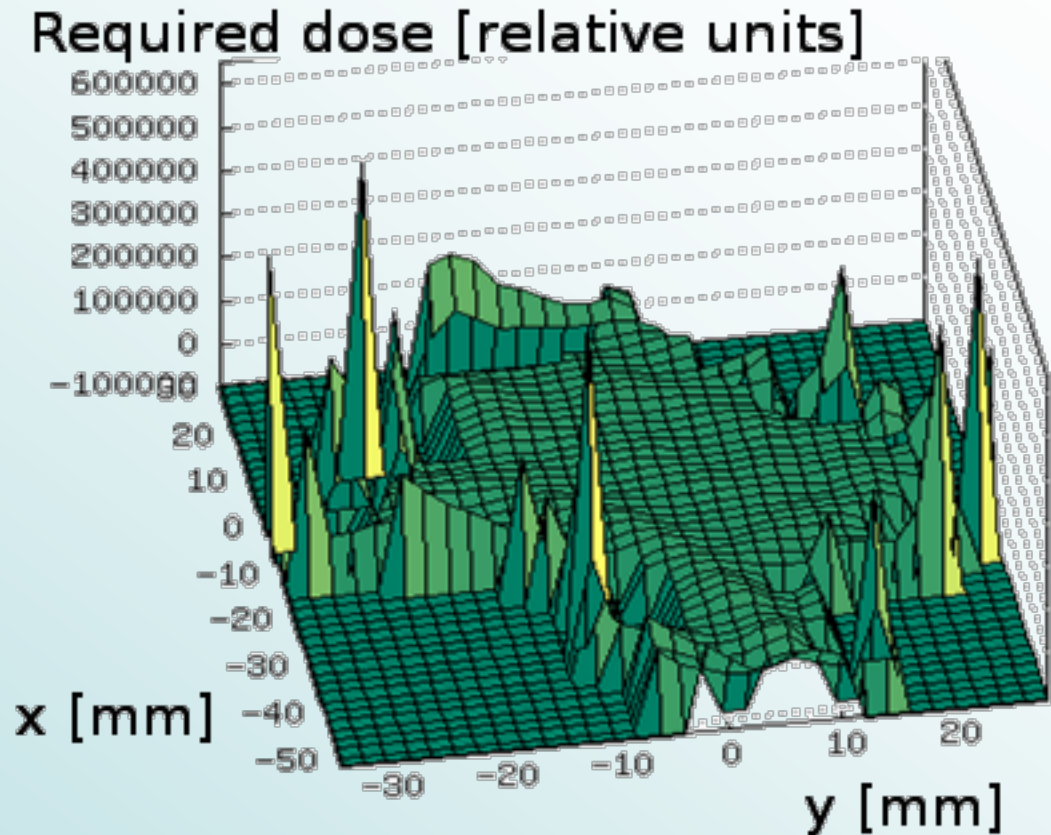

Intensity-modulated spill

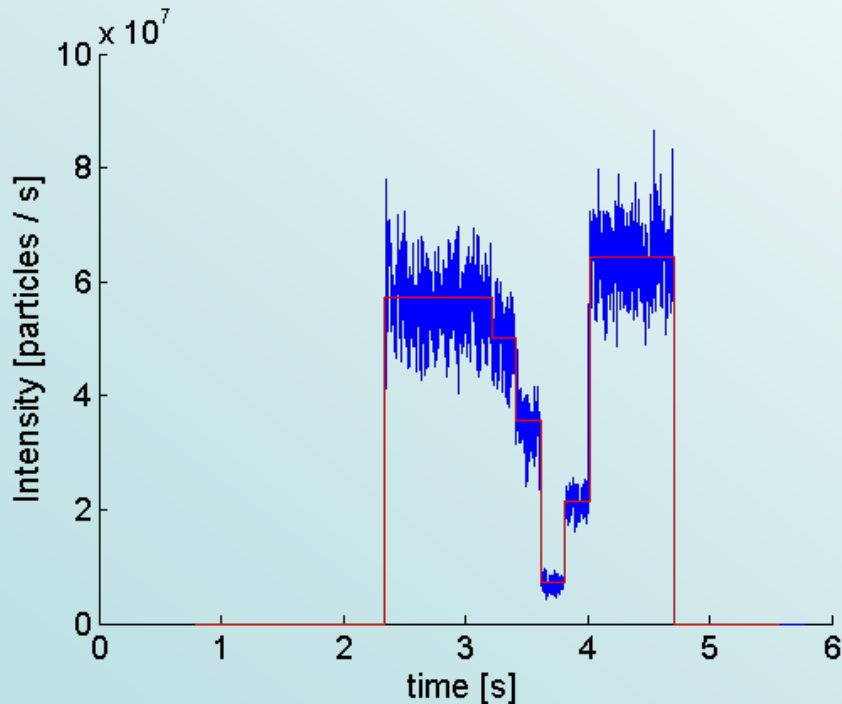

- Alternating reference value
 - Each raster point is irradiated by an individual particle rate
 - Intensity can be changed within ms
- smaller scale as time for one raster point

Summary & Outlook

- Feedback loop for flat spill is in operation for experiments
- Implementation into clinical routine after risk analysis and approval
- Treatment plan specific dynamic intensity is available for further tests
- Extended real time connection to therapy system required for individual raster point intensity

Thank you for your attention!

...and to these people for their support:

- E. Feldmeier, Th. Haberer, J. Naumann, R. Panse, A. Peters (HIT)
- Dr. Martin Bräuer (Siemens AG)



Dose distribution II

