

FABRICATION AND TESTING OF THE FIRST MAGNET PACKAGE PROTOTYPE FOR THE SRF LINAC OF LIPAC*

S. Sanz[#], F. de Aragón, J. Calero, J. de la Gama, J.L. Gutiérrez, I. Moya, I. Podadera, F. Toral, CIEMAT, Madrid

N. Bazin, P. Bosland, P. Brédy, G. Disset, N. Grouas, P. Hardy, V. Hennion, H. Jenhani, J. Migne, F. Orsini, J. Relland, B. Renard, CEA, Saclay, France

E. Zaplatin, FZJ, Jülich, Germany

Abstract

The Linear IFMIF Prototype Accelerator (LIPAc) will be a 9 MeV, 125 mA CW deuteron accelerator which aims to validate the technology that will be used in the future IFMIF accelerator. The SRF Linac design is based on superconducting Half Wave Resonators (HWR) cavities operating at 4.4 K. Due to space charge associated to the high intensity beam, a short, but strong, superconducting focusing magnet package is necessary between cavities. The selected configuration has been a superconducting NbTi solenoid acting as a magnetic lens and a concentric outer solenoid in antiparallel configuration to reduce the harmful stray field on the cavities. The selected arrangement for the steerers is a pair of parallel racetrack coils for each vertical and horizontal axis. This paper describes the manufacturing techniques of the different coils, and the tests realized in warm and cold conditions. Special attention is put to the training test of the main solenoid, since the nominal working point in the load line is very high (86.2%).

INTRODUCTION

The LIPAc [1] deuteron beam will be accelerated in superconducting Half Wave Resonators (HWR) made of Niobium and working at 4.4 K. The most challenging aspect of this accelerator is its high beam current, 125 mA [2]. Eight cavities and magnet packages are grouped in a cryomodule, as shown in Figure 1. The whole subsystem, called SRF Linac, is coordinated by CEA/Saclay, which also holds the responsibility of production of the cavities, the associated components and the tank itself [3].

A magnet package will be placed before each cavity. The magnet packages, current leads and magnet power supplies are provided by CIEMAT, as part of the Spanish contribution to LIPAc. The magnet package design is described elsewhere [5]. The current leads are still being designed. The three main purposes of that package are:

- Focusing the deuteron beam by means of a NbTi solenoid. A nominal integrated field of 1.1T·msatisfies the optics requirements, including a 10% safety margin. An outer concentric solenoid with opposite current sense will shield the stray field, keeping the field at the cavities below 20 mT.
- Two steerers are foreseen to correct the vertical and horizontal beam trajectory. They will provide an

integrated dipolar field of 3.51 mT.m, able to cope with the following misalignment errors: up to 0.5 mm and 5 mrad in the focusing solenoids, and 1 mm and 10 mrad in the case of the cavities.

- An integrated cold BPM to pick up the beam position [4].

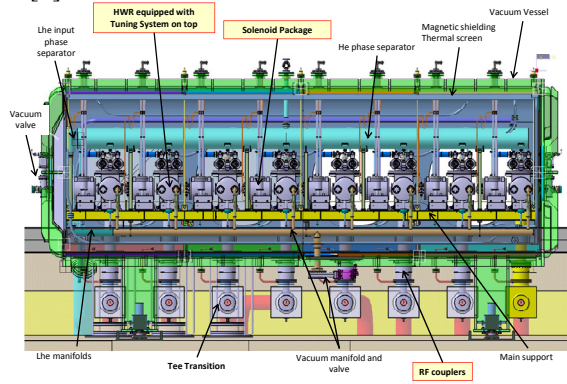

Figure 1: Layout of the SRF Linac.

COIL MANUFACTURING

Inner Solenoid

The inner solenoid coil (see Fig. 2, left) is the most difficult one to wind because of the high number of turns: 5478. It is wound with a round, 0.75 mm diameter, NbTi enamelled wire. The mandrel is made from aluminium, with two caps which makes the reference of the pin holes drilled on both endplates of the solenoid (see Fig. 2, right). These endplates will align the vacuum vessel, the BPM and the solenoid in the final magnet package assembly.

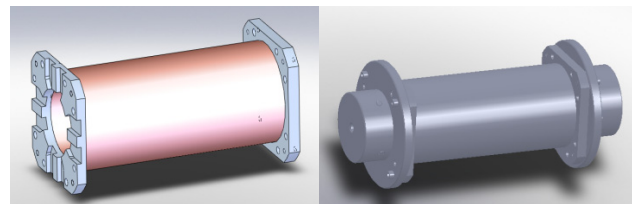

Figure 2: CAD model of the inner solenoid (left) and the winding tooling (right).

Once each layer is wound, it is wet impregnated with Araldite 2011 epoxy resin, which is suitable for cryogenic use. Due to the high number of layers, one needs to be especially careful with the pot life of the resin. The solenoid endplates (made from G11) are glued at the same time. The mandrel is extracted after curing the resin in an

*Work partially supported by Spanish Ministry of Science and Innovation under projects AIC10-A-000441 and ENE2009-11230.

[#]s.sanz@ciemat.es

oven with help of a sudden immersion in a LN₂ bath. Because of that, a PTFE foil was wrapped around the mandrel, glued and turned (see Fig. 3, left). Besides, all the parts have been sprinkled with releasing agent.

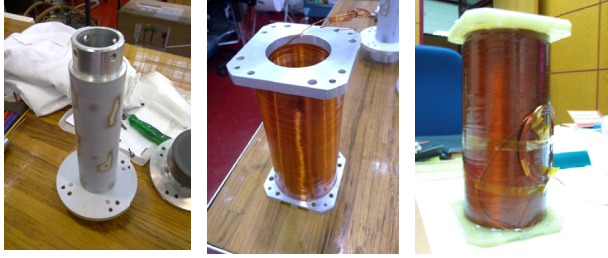

Figure 3: Mandrel protected with PTFE foil (left), dummy copper solenoid with aluminium endplates (centre), finished NbTi solenoid (right).

A dummy coil with copper wire of similar diameter was made (see Fig. 3, centre). It was proven that the winding could be done in two days, provided that the resin applied on the last layer of the first day was uniformly distributed. The result was satisfactory, except the coil ends, where it was not possible to maintain a regular winding in the outer layers. Approximately 1% of turns were missed, but it was checked with FEM that, although the integrated field reduction was similar in magnitude, the field profile and the stray field are not affected.

Then, once the procedure was validated, the superconducting coil was wound following the same techniques (see Fig. 3, right). To ensure that the glass fibre endplates were properly glued, the solenoid was successfully thermal cycled with LN₂.

Outer Solenoid

The outer solenoid was made in a similar way (see Fig. 4, up left). The only difference between the wires is the ratio Cu:Sc, which is higher in the outer solenoid (3.2) than in the inner one (1.5), since the field is lower.

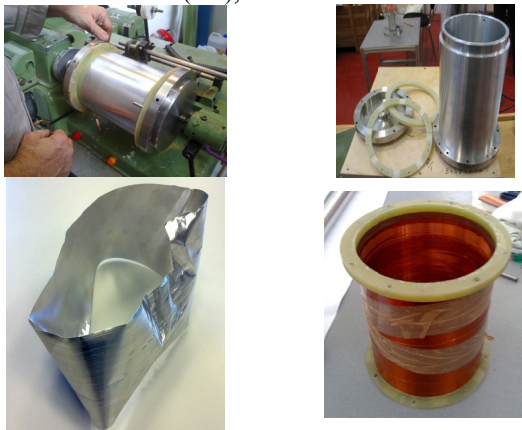

Figure 4: Fabrication of the outer solenoid: winding (up left), tooling and glass fibre endplates (up right), thin mandrel after de-moulding (down left) and finished solenoid (down right).

As it has only five layers, the mandrel was not coated with PTFE, only with releasing agent. The de-moulding

with a liquid nitrogen bath failed, so the mandrel was turned with a lathe, as far as only a 0.1 mm thick layer was left, and tore away (see Fig. 4, up right and down left). The endplates gluing is reinforced with a G11 strip, to avoid any risk of de-bonding.

Steerer Coils

The winding tooling and the support for the steerer coils is shown in Figure 5. The wire is the same than the outer solenoid, also wet impregnated. The external clamps provide the right geometry during the curing in the oven.

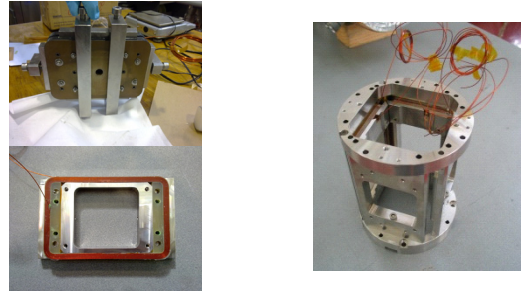

Figure 5: Steerer tooling (left up), finished coil (left down), steerers support (right).

TESTS AT WARM CONDITIONS

First of all, the self-inductance of the coils was measured at different frequencies to guarantee the lack of short-circuits. The steerer coil labelled B4 is discarded due to a different behaviour at high frequency respect the rest of coils. DC resistances are also according to expected values. The results are summarized in Table 1. (R is resistance, L is inductance and D is the loss tangent).

Table 1: Electrical Measurements on the Coils

	Inner sol.	Outer sol.	Steer. B1	Steer. B2	Steer. B3	Steer. B4	Steer. B5
R (Ω ,DC)	90.4	36.6	1.773	1.8	1.763	1.776	1.767
R (Ω ,100 Hz)	93.1	38.65	1.765	1.791	1.753	1.7619	1.7482
D (100 Hz)	0.2331	0.3718	2.3	2.32	2.284	2.303	2.271
L (μ H,100Hz)	636000	165400	1220.6	1228.9	1221	1217.3	1225.2
D (10 kHz)	0.048	0.0263	0.03	0.031	0.03	0.057	0.03
L (μ H,10kHz)	-340000	-33300	1219.8	1227.9	1220.3	1214.7	1224.3

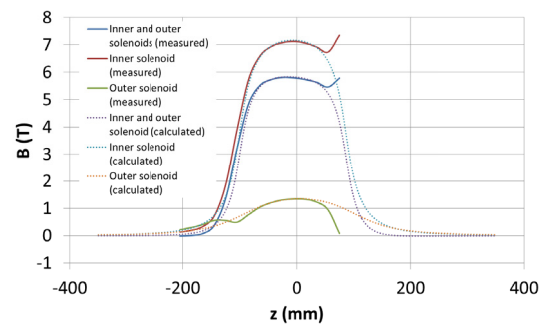

Figure 6: Comparison between measured and calculated magnetic field along the solenoid axis.

The magnetic field profile along the solenoid axis was measured with a Hall sensor at a reduced current of 102.2 mA. The results are represented in Figure 6, where the field is scaled at the nominal current. The highest discrepancies correspond to one half of the solenoid, where some near magnetic parts could affect the measurements. On the other side, some difference can be found, likely due to the steel pins used for alignment.

COLD TESTS

The solenoids were tested in a vertical cryostat at 4.2 K to check: a) the training of the magnet, due to the high nominal working point on the load line (86.2%), b) the mechanical damage after thermal cycling, and c) the necessity of a quench protection system.

The setup was prepared to energize independently the inner coil, the outer coil or both coils in series (see Figure 7). The beam tube was also attached, to decrease the volume of liquid helium in contact with the solenoid bore, but it was not possible to simulate the real working position (horizontal), due to the size limitation of the available cryostat. The bath temperature was 4.2 K instead of 4.4 K, foreseen for the LIPAC cryomodule bath. It implies that the critical current will be reduced by 7%, approximately.



Figure 7: Prototype solenoids prepared for cold tests.

The nominal current is 210 A. The outer coil (independently powered) reached without any quench up to 220 A. The inner coil achieved 177.4 A without any quench, which yields the same coil field than the nominal current with both coils powered in series, since the outer coil reduces the peak field in the inner coil.

When both coils are powered together, the first quench was at 240.8 A, well above the nominal one. The current decay and the overall inductive voltage recorded during the quench are displayed in Figure 8, as well as the calculated ones. The fit is reasonably good. Since the winding is regular, that is, the wires in each layer are connected in series, and then to the adjacent layer, an overall inductive voltage of 700 V is not too high for the enamel insulation of the superconducting wires.

The following quenches took place at 263.0 and 262.9 A, about the short sample critical current of the wire. From these test results, all the objectives are fulfilled. The magnets do not need a fast quench protection system.

Nevertheless, it was not possible to measure the field profile along the axis at cold conditions, since the magnetic probe was damaged during the test. Another test is planned in the near future to check that there is no degradation of the critical current after a thermal cycle and, additionally, to check the steerers at cold conditions with the nominal background field. Besides, the magnetic field profile will be measured.

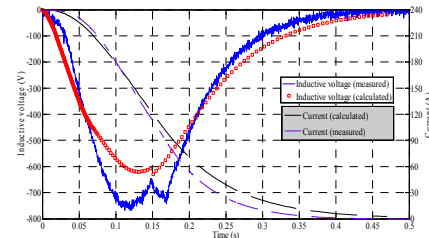

Figure 8: Measured and computed quench propagation parameters.

CONCLUSIONS

The solenoid coils for the first magnet package of LIPAC SRF linac have been manufactured and validated. All the coils have been wound with wet impregnation.

The first cold tests at 4.2 K were performed in a vertical cryostat, although the magnet will be placed horizontally in LIPAC. The theoretical critical current of the magnet was fulfilled, with a very short training.

It was checked that the coils are self-protected during quench. So, a fast protection system is not needed.

ACKNOWLEDGMENTS

The authors want to thank Prisma Diseño Industrial for CAD models and drawing production, and CIEMAT Fusion Department Workshop for the parts machining.

REFERENCES

- [1] A. Mosnier et al., “Development of the IFMIF-EVEDA Accelerator”, PAC09, Vancouver, Canada, TU2RAI01, p. 663 (2009).
- [2] N. Chauvin et al., “Alternative Designs and Beam Dynamics Simulations of the SC HWR of the IFMIF Linac”, PAC09, Vancouver, Canada, TH5FPF005, p. 3193 (2009).
- [3] F. Orsini et al., “Vertical tests, preliminary results of the IFMIF cavity prototypes and cryomodule development”SRF2011, Chicago, USA, THIOB02.
- [4] I. Podadera et al., “Design status of beam position monitors for IFMIF-EVEDA accelerator”, DIPAC 2009 Basel, Switzerland, MOPD06.
- [5] S. Sanz et al., “Calculation and design of the magnet package in the IFMIF superconducting RF Linac”, IPAC 2010 Kyoto, June 2010, MOBP041.