

# RESEARCH OF THERMAL DEFORMATION ON A COMPACT CYCLOTRON CYCHU-10

K. Liu\*, D. Li, T. Hu, J. Xiong, J. Yang, W. Wei, J. Chen

College of Electrical and Electronic Engineering (CEEE) Huazhong University of Science and Technology (HUST), Wuhan, China

## Abstract

Nowadays, a cyclotron CYCHU-10 used for PET is under construction in Huazhong University of Science and Technology (HUST) due to the growing demands in medical applications. For space-saving and low energy consumption, the CYCHU-10 was designed compactly and accurately, especially for the RF cavities consist of the valley of the magnetic poles and the Dee electrodes installed on the vacuum chamber. The RF system will supply a 10kw power and large part of it will transform into thermal energy. This paper will introduce the thermal deformation of the RF cavities. Meanwhile the finite elements analysis thermal deformation with ANSYS Products will be present. Finally, the cooling system for the RF cavity and the vacuum chamber will be designed due to the result of thermal analysis and the mechanical tolerance demand in the RF system.

## INTRODUCTION

A cyclotron CYCHU-10 used for PET is under construction in Huazhong University of Science and Technology (HUST) due to the growing demands in medical applications<sup>[1]</sup>. For space-saving and low energy consumption, the CYCHU-10 compact cyclotron adopts shallow valley type resonant cavity. The Dees and RF power feeding part are installed on the main chamber which is situated magnet pole. Fig. 1 shows the layout in the mid-plane.

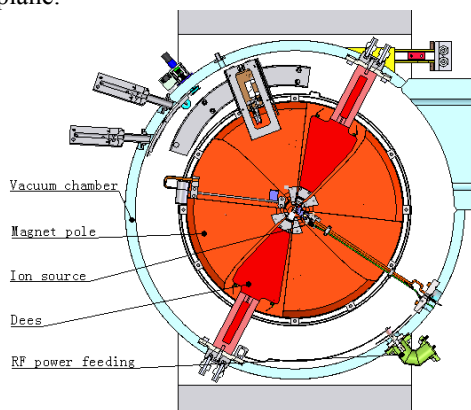

Figure 1: Layout of the resonant cavity

For the sake of compactness, we use the non-uniform characteristic impedance coaxial structure for cavity design, and the magnet surface electroplated with copper will be used as dummy Dees. The main specifications are shown in table 1<sup>[2]</sup>.

\*E-mail: kfliuhust@yahoo.cn

Table 1: Main Specifications of CYCHU-10

Parameter	Value
Beam species	Negative hydrogen
Maximum beam energy	10 MeV
Sector numbers	4
Sector open angle	48~53 Degrees
Radio frequency	99.2 MHz
Hill / valley gap size	2.5 cm / 9.0 cm
RF power	10KW
Central magnetic field	1.63 T
Vacuum Chamber Radius	480 mm

The RF power is 10KW and large part of it will transform into thermal energy which causes the deformation on the Dees and the vacuum chamber. The thermal deformation will be analyzed and the cooling system design for the RF cavity and the vacuum chamber will be present in this paper.

## THERMAL MODEL

Figure 2 shows the whole thermal analysis model of the RF cavity. The RF cavity which adopts coaxial type resonant cavity is a compact design. It consists of the cupreous Dees and the valley of the magnet pole with copper plating.

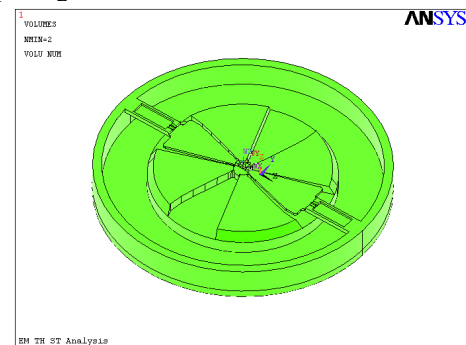

Figure 2: Thermal analysis models in ANSYS

The RF system will supply 10KW power, but most will lose and Convert into heat. The structure of the Dee is shown in Fig. 3. The cavity is divided into a series of units with the same natural impedance. Fig. 4 shows the equivalent circuit.

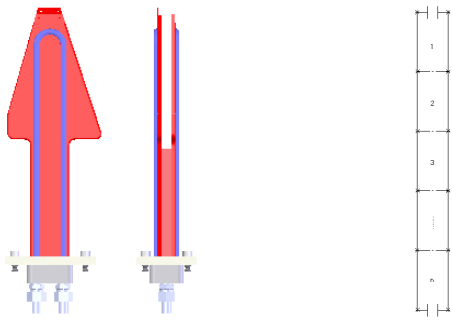

Figure 3: CYCHU-10 Dee. Figure 4: Equivalent circuit.

The power loss of the cavity can be calculated as follow [3]:

$$P = \frac{1}{2} \sum_{i=1}^n R_{eq,i} \int_0^l I_i^2(z) dz + \text{Special power loss} \quad (1)$$

where n is the total segmentation number of the cavity, and  $R_{eq,i}$  is the equivalent impedance of subsection i.

The equivalent impedance of each subsection is decided by the surface geometrical factors of the inside and outside conductors. If the current distribution is homogeneous,  $R_{eq}$  can be calculated as follow:

$$R_{eq} = R_s \left( \frac{1}{P_{int}} + \frac{1}{P_{ext}} \right) \quad (2)$$

where  $P_{int}$  and  $P_{ext}$  are the circumference of the inside and outside conductors.  $R_s$  is surface impedance and it can be calculated as follow:

$$R_s = \frac{1}{\sigma \delta} \sqrt{\frac{\pi \mu f}{\sigma}} \quad (3)$$

where  $\delta$  is skin depth, and  $\mu$  is permeability, and  $f$  is frequency.

Special power loss in eq. (3) means energy loss at special parts of the cavity, such as short circuit sheet. The special power loss should be calculated independently.

### THERMAL CALCULATION

In this system, water is used for cooling liquid. The conductive coefficient of the cooling system can be calculated as follow [4]:

$$h = A * (k / d) * (d * v * \rho / \mu)^a * (C_p * \mu / k)^b \quad (4)$$

Where h is conductive coefficient ( $W / (m^2 K)$ ), and A is a proportional constant with value between 0.0265~0.027 for water, and k is fluid thermal conductivity ( $W / (m * K)$ ), and d is tube inside diameter (m), and v is fluid velocity (m/s), and  $\rho$  is fluid density, and  $\mu$  is fluid viscosity ( $Kg / (m * s)$ ), and  $C_p$  is fluid specific heat capacity ( $J / (Kg * K)$ ), and a, b are constants with value 0.8, 0.33 for water.

All above parameters are shown in table 2.

Table 2: Thermal Analysis Parameter

Parameter	Value	Parameter	Value
$A$	0.27	$d$	0.008
$k$	0.609	$\mu$	1.002e-3
$\rho$	1000	$v$	16
$C_p$	4.1819e3	$h$	4.7248e4

Analysing in AYSY we get the temperature distribution on the surface of the resonant cavities conductor as shown in Fig. 5.

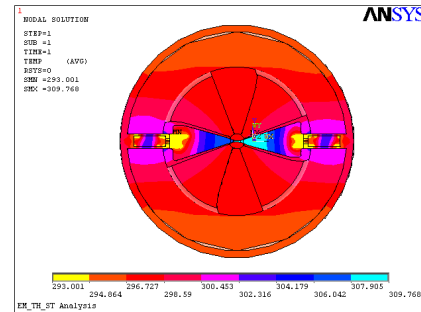

Figure 5: Temperature distribution on the resonant cavities.

Figure 6 shows the temperature variation of the direction along the radius.

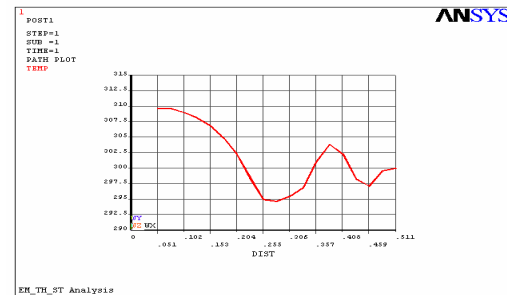

Figure 6: Temperature variation of the direction along the radius.

There are conclusions as follow from Fig. 5 and Fig. 6:

- (1) The temperature distribution on the two resonant cavities is symmetrical. The maximum temperature is 309°F while the minimum temperature is 293°F.
- (2) On the inside conductor, the temperature on the head of the Dee is the highest because there is no water cooling. Temperature of the vacuum chamber area far away the stem fall to external environment temperature rapidly.

### FREQUENCY DRIFT

The thermal deformation of the resonant cavity may bring about frequency drift. Design against frequency drift should be considered since the thermal deformation can not be avoided.

The result of total deformation displacement is shown in Fig. '7.' Fig.'8 and Fig. '9 show the direction cavity deformation displacement and the deformation of Dee of the direction along the radius

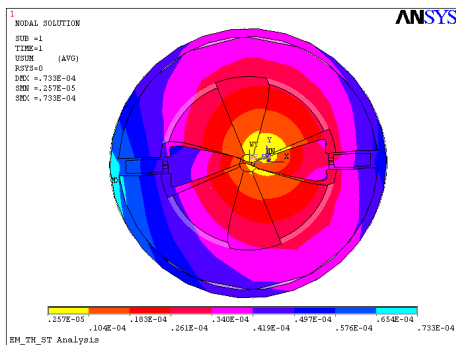

Figure 7: Total deformation displacement.

According to the analysis results in ANSYS, the maximum deformation of the resonant cavity is 0.0733 mm and the minimum is 0.00257 mm. The maximum deformation of the inside conductor is 0.054 mm while the minimum is 0.012 mm.

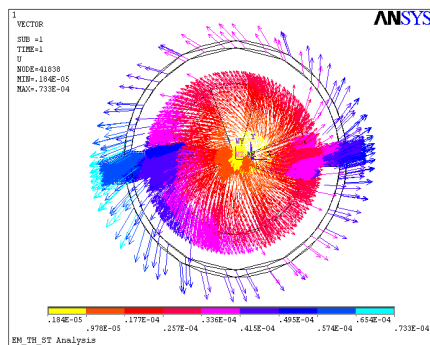

Figure 8: Direction of cavity deformation displacement.

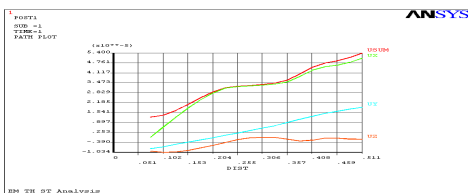

Figure 9: Deformation of Dee of the direction along the radius.

By using ANSYS the frequency of the resonant cavity can be calculated.

SUMMARY OF QUALITY FACTOR CALCULATION

Frequency: 0.100061019 GHz.

Quality factor (dielectric loss only): 0.

Quality factor (surface loss only): 7954.51081.

Quality factor (dielectric and surface loss): 7954.51081.

(a) Without deformation

SUMMARY OF QUALITY FACTOR CALCULATION

Frequency: 0.100272490 GHz.

Quality factor (dielectric loss only): 0.

Quality factor (surface loss only): 8050.45772.

Quality factor (dielectric and surface loss): 8050.45772.

(b) Deformed cavities

Figure 10: Frequency calculation.

It is easy to know from figure 10 that the frequency drift is 0.21MHz due to the thermal deformation. To eliminate the frequency drift, four capacitive frequency trimmers are designed to adjust the frequency to the right value as shown in Fig. 1.

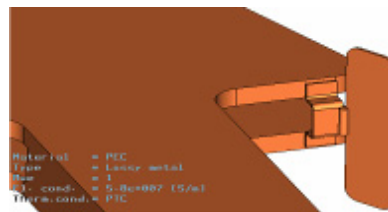

Figure 11: Model of fine tuning capacitance.

The capacitive frequency trimmers can be adjusted independently.

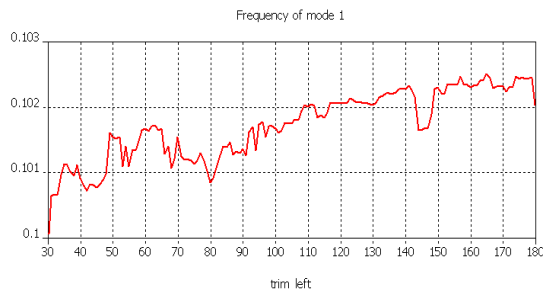

Figure 12: Frequency change by adjusting the capacitive frequency trimmers.

The adjustment range of frequency is 2.44MHz according to Fig.12. So this range size is enough to eliminate the frequency drift (0.21MHz) caused by thermal deformation.

### CONCLUSION

The thermal deformation is calculated and the parameter of the cooling system is proved by using ANSYS. The deformation of the cavity leads to frequency drift of the cyclotron. And the capacitive frequency trimmers is designed to eliminate the frequency drift. All these results will be used to guide the manufacture progress of CYCHU-10 cyclotron.

### REFERENCES

- [1] B. Qin, J. Yang, K. Liu, Z. Huang, L. Zhao, C. Chu, M. Fan, Small valley gap magnet design for a 10MeV PET cyclotron, ICEMS 2008.
- [2] B. Qin #, J. Yang, K. Liu, D. Li, L. Zhao, T. Yu, Y. Xiong, M. Fan, Main Magnet and Central Region Design for a 10 MeV PET cyclotron CYCHU-10, Proceeding of Particle Accelerator Conference, Canada, 2009, MO6PFP022.
- [3] T. Zhang, M. Fan. Physics and engineering technology. Beijing: Atomic Energy Press, 2010.
- [4] John M. Campbell. Gas Conditioning and Processing, Volume 2: The Equipment Modules, Seventh Edition, Campbell Petroleum Series, 1992: 125