

# TOWARDS CLIC FEASIBILITY

J. P. Delahaye for the CLIC/CTF3 Collaboration, CERN, Geneva, Switzerland

## Abstract

The CLIC study is a site independent study exploring technological developments to extend linear colliders into the Multi-TeV colliding beam energy range at reasonable cost and power consumption. A conceptual design report (CDR) of an electron-positron Compact Linear Collider (CLIC) in the Multi-TeV energy range up to 3 TeV centre-of-mass colliding beam energy is being prepared including results of 25 years of R&D to address the feasibility of its novel and promising technology, especially in an ambitious Test Facility, CTF3. The R&D is performed by a multi-lateral CLIC/CTF3 collaboration [1] strong of 38 volunteer institutes from 19 countries.

## INTRODUCTION

CERN's latest and foremost accelerator, the LHC [2], will probe a new "terascale" energy region and provide a rich program of physics at a new high-energy frontier over the coming years. The discovery potential is huge and will set the direction for future high-energy colliders. Particle physicists worldwide supported by ICFA [3] have reached a consensus that the results of the LHC will need to be complemented by experiments at a lepton collider in the TeV energy range. The required energy range will be better defined following Physics requirements based on LHC results when substantial integrated luminosity will have been accumulated, tentatively in 2013-14.

The highest energy of lepton collisions so far, 209 GeV, was reached in LEP [4] limited by synchrotron radiation. Since synchrotron radiation is inversely proportional to the bending radius and to the fourth power of the particle mass, two alternatives are being explored to overcome this limitation and build a terascale lepton collider: i) use muons with a mass 207 times larger than electrons. The feasibility of Muon Colliders is being studied [5] addressing critical challenges specially the limited lifetime (2  $\mu$ s) of the muons and their production in large emittances requiring novel cooling methods, ii) use  $e^{\pm}$ -linear colliders thus mitigating particle trajectories bends.

Following the successful development and operation of the 100 GeV SLC [6] at SLAC, about 25 years of R&D, exploring various alternatives, have greatly improved the performances of Linear Colliders. Global collaborations are currently developing two alternative technologies, each with different energy reach. Following an ICFA recommendation [3] for a Linear Colliders in the TeV energy range, the International Linear Collider (ILC) [7] is based on beam acceleration by RF Super-Conducting structures. A Reference Design Report (RDR) has been published in 2007 and a Technical design Report (TDR) is foreseen in 2012. The Compact Linear Collider (CLIC) study is exploring the possibility to extend the energy reach of Linear Colliders into the Multi-TeV energy range by developing a novel technology of Two Beam

Acceleration. The feasibility of such a technology over a wide energy range up to 3 TeV is studied by a world-wide multilateral collaboration [1] strong of 38 volunteer institutes from 19 countries. The feasibility results together with the conceptual design of a 3 TeV Linear Collider will be published by mid 2011. These two studies are complementary in the preparation for the most appropriate facility to complement the LHC. Taking advantages of large number of synergies, a close collaboration between CLIC and ILC has been launched and is extremely fruitful.

## CLIC SCHEME OVERVIEW

In order to identify the requirements of an electron-positron collider in the multi-TeV energy range and following preliminary Physics studies [8,9], the CLIC study is focused on the design of a linear collider at a colliding beam energy of 3 TeV with a luminosity of  $2.10^{34} \text{ cm}^{-2} \text{ s}^{-1}$ . A design is deduced at a lower energy, arbitrarily set to 500 GeV with the same luminosity for comparison with the alternative ILC technology and to identify the parameters variation in the 0.5 to 3 TeV energy range. An overall review of the CLIC design is available [10] with detailed information [11]. The layout of a 3 TeV CLIC is displayed on Figure 1. The major parameters at 500 GeV and 3 TeV are shown on table 1.

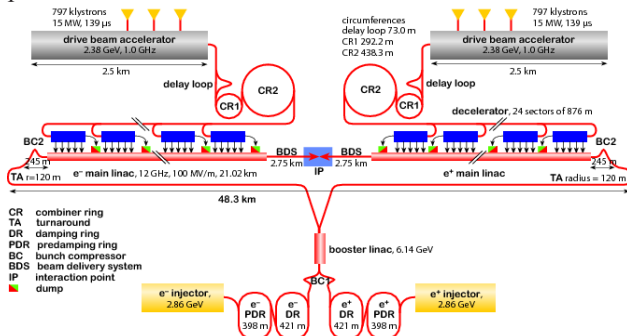

Figure 1: CLIC layout at 3 TeV.

Table 1: Main CLIC Parameters

Parameter	0.5 TeV	3 TeV	Unit
Luminosity(1%energy)	1.4	2	$10^{34} \text{ cm}^{-2} \text{ s}^{-1}$
Accelerating field	80	100	MV/m
Overall length	13	48.3	kms
Repetition rate		50	Hz
Particles/bunch	6.8	3.7	$10^9 \text{ e}^{\pm}$
Bunch interval		0.5	ns
Bunches/beam train	354	312	-
H/V beam emitt. at IP	4800/25	660/20	n-radm
H/V beam size at IP	202 /2.3	40 / 1	nm
Beam power/linac	4.9	14	MW
Total site AC power	130	415	MW

In order to limit the overall extension of the facility and its corresponding cost, the 3 TeV CLIC scheme is based on beam acceleration with (beam loaded) electric fields of 100 MV/m in normal conducting travelling wave accelerating structures operating at an RF frequency of 12 GHz. Such fields require high peak power (typically 250 MW each meter of the 21km linacs). For the sake of cost mitigation and power efficiency, a novel power source – an innovative two-beam system - in which the RF power is extracted from a low energy but high-intensity drive beam, is developed. The required luminosity is reached with powerful beams (14 MW each) colliding with extremely small dimensions (1 nm in the vertical plane) and high beam stability. Such small dimensions can only be obtained with extremely small emittances. For the sake of power mitigation, all processes from wall plug to beam acceleration have to be as power efficient as possible. Therefore, the quest for beam performances beyond both energy and luminosity frontiers with affordable cost and power consumption imposes the development of an innovative scheme with parameters well above the present standards. Addressing their feasibility is the key for the Multi-TeV  $e^{+/-}$  colliding energy range. Such a technology when available could be used for a first stage collider in the sub-TeV energy range with less challenging parameters and reduced cost.

## FEASIBILITY ISSUES

Such an innovative scheme with challenging parameters raises a number of issues. They have been classified in three categories: i) feasibility issues, ii) performances issues, iii) cost issues. The feasibility issues corresponding to possible show-stoppers are all being addressed. They need to be demonstrated before the CLIC concept can be validated. The issues related to performance and cost although partially addressed will be subject of the Technical Design Phase. Ten major issues have been

Table 2: CLIC Feasibility Issues & Critical Parameters

System	Item	Feasibility Issue	Unit	Nominal
Two Beam Acceleration	Drive beam generation	Fully loaded accel effc	%	96
		Freq&Current multipl	-	2*3*4
		12 GHz beam current	A	4.5*24=100
		12 GHz pulse length	nsec	170
		Intensity stability	1.E-03	0.75
	Timing stability	psec	0.05	
	Beam Driven RF power generation	PETS RF Power	MW	130
		PETS Pulse length	ns	170
		PETS Breakdown rate	/m	< 1*10 <sup>-7</sup>
		PETS ON/OFF	-	@ 50Hz
Accelerating Structures (CAS)	Drive beam to RF efficiency	%	90%	
	RF pulse shape control	%	< 0.1%	
	Structure Acc field	MV/m	100	
Two Beam Acceleration	Structure Pulse length	ns	240	
	Structure Breakdown rate	/m MV/m.ns	< 3*10 <sup>-7</sup>	
	Power production and probe beam acceleration in Two beam module	MW/m - ns	100 - 240	
Ultra low beam emittances & sizes	Alignment	Drive to main beams timing stability	psec	0.07
		Emittance generation (H/V)	nm	550/5
		Emittance preservation: Blow-up H/V	nm	160/15
	Vertical stabilisation	Beam sizes at IP (H/V)	nm	40/1
		Main Linac components	microns	15
		Final-Doublet	microns	8
Operation and Machine Protection System (MPS)	Quad Main Linac	nm>1 Hz	1.5	
	Final Doublet (assuming feedbacks)	nm>4 Hz	0.2	
Operation and Machine Protection System (MPS)	Drive Beam Power @ 2.4GeV	MW	24*3	
	Main Beam Power @ 1.5TeV	MW	14	

clearly identified. The eight concerning the accelerator are summarised in Table 2 with their critical parameters. The other two concern the detector. They are related to the time stamping due to the short time interval of 0.5 ns inherent to the normal conducting accelerating structure technology and the large background induced by beamstrahlung at high beam collision energy. They are addressed by a new Linear Collider Detector (LCD) [12] project. R&D presently launched, major results already achieved and outlook are briefly summarised below.

## Drive Beam Generation

*Issues:* Novel scheme of beam intensity and frequency multiplication by a factor 12 to generate a 100 Amp drive beam with 12 GHz bunch frequency and high efficiency.

*R&D:* Ambitious test facility, CTF3 [13], to produce a 28 Amp drive beam with 12 GHz bunch repetition frequency by factor 8 multiplication and acceleration with fully loaded linac for high RF to beam efficiency.

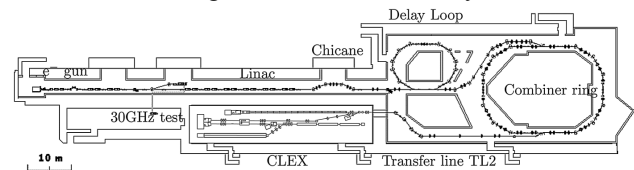

Figure 2: CLIC Test Facility (CTF3).

*Achieved performance:* CTF3 built, under commissioning and operated thousands of hours/year. Nominal CTF3 beam performance already demonstrated [14] with 27 A at 12 GHz and acceleration to 120 MeV with 95% RF to beam efficiency with an intensity stability of  $2 \cdot 10^{-3}$  (nom.:  $0.75 \cdot 10^{-3}$ ) and timing stability of 0.1 ps (nom.: 0.05 ps).

*Outlook:* Operational experience, improved availability of the complex used as a reliable and efficient power source. Feedbacks to further improve beam timing and stability.

## Beam Driven RF Generation

*Issues:* Development of a beam driven Power Extraction Structure (PETS) delivering 135 MWatts for 240 ns equipped with ON/OFF of the generated power. Extraction of up to 90% of beam energy by successive use of PETS components with reliable beam stability.

*R&D:* Construction and tests with beam of PETS structures [15]. Development of a prototype ON/OFF mechanism. Test Beam Line [16] equipped with 16 PETS for tests with the 28A/120 MeV drive beam in the CLEX area of CTF3 with up to 60% beam power extraction efficiency.

*Achieved performance:* 137 MWatts for 266 ns and  $10^{-6}$  breakdown rate (Figure 3) by PETS prototype (no HOM loads yet) driven by a 11.4 GHz klystron in SLAC/ASTA facility. 170 MWatts peak power by a 10 A beam driven PETS with 12 GHz RF recirculation at CTF3

*Outlook:* Measurements of PETS equipped with HOM in 2010. Power and beam measurements in TBL equipped with 8 PETS early 2011 and fully equipped late 2011.

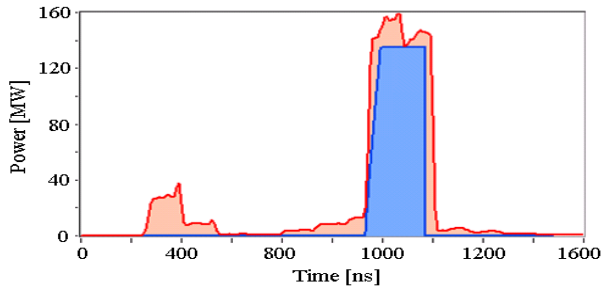

Figure 3: Typical compressed RF pulse in SLAC ASTA (red) compared with the target CLIC RF pulse (blue).

### Accelerating Structures

*Issues:* Development of accelerating structures with 100 MV/m (beam loaded) field during 240 ns with a breakdown rate of  $< 3 \cdot 10^{-7}/m$  and equipped with damping of high order modes.

*R&D:* RF design [17], construction and tests with beam of number of structures in close collaboration with a large number of laboratories, especially SLAC and KEK taking advantage of their large expertise and test facilities.

*Achieved performance:* Summarised in table below for structures equipped (TD) or not (T) with damping waveguides and identifying the laboratory (SLAC or KEK) where tests with RF power are performed: Nominal performances achieved for (T), under tests for (TD).

Structure name	Unloaded gradient	Pulse length (flat top)	Breakdown rate	Status RF conditioning
Unit	MV/m	ns	/pulse/m	
T18 #1	105	230	$8 \cdot 10^{-7}$	done@SLAC
T18 #2	102	252	$8 \cdot 10^{-7}$	done@KEK
T18 #3	95	230	$8 \cdot 10^{-7}$	Progressing @ SLAC
TD18 #1	81	230	$8 \cdot 10^{-7}$	done@SLAC
TD18 #2	88	252	$2 \cdot 10^{-6}$	Progressing @ KEK

*Outlook:* Nominal T24 and TD24 structures with better RF to beam efficiency being built and under tests soon at SLAC and KEK

### Two Beam Acceleration

*Issues:* Demonstration of novel scheme of two beam acceleration in compact modules [18] integrating all technical systems for RF production, beam measurement and acceleration including alignment, stabilisation and vacuum at their nominal parameters.

*R&D:* Build prototype and test of individual components in fully equipped modules (Figure 4) of various (4) kinds first in laboratory and then in the CLEX area of CTF3.

*Achieved performance:* Beam-powered test of individual components. Manufacture and installation of fully equipped two-beam modules in dedicated laboratory.

*Outlook:* Manufacturing and installation of three two-beam modules in CLEX and validation with beam of the two beam acceleration up to 2013.

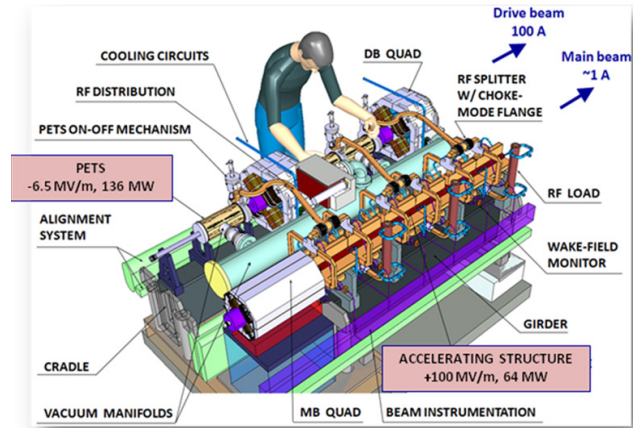

Figure 4: Two Beam modules.

### Ultra low Beam Emittances

*Issues:* Key for limitation of beam power at high luminosity at 3 TeV is the generation of ultra low normalised emittances ( $H/V=500/5nm$ ) and their preservation during acceleration and beam focusing at IP ( $H/V=660/20 nm$ ). At 500 GeV, emittances are considerably relaxed ( $H/V=4000/10 nm$ ) at DR and ( $H/V=4800/25 nm$ ) at IP.

*R&D:* DR design [19] with nominal performances based on damping wigglers with high field and short period ( $2.5T/50mm$ ). Fast ion instability avoided with ultra low vacuum (0.1nTorr) and electron cloud mitigated by low Secondary Emission Yield ( $<1.3$ ) with amorphous carbon coated vacuum chamber tested in CESR-TA. Transient beam loading by high beam current in 1GHz RF cavity.

*Achieved performance:* Nominal performances achieved in short SC wiggler mock-up. Nominal emittances preserved by strong focusing lattice with beam-based alignment and tuning procedures [20]. Concept of a main and drive beam phase and amplitude feedback.

*Outlook:* Wiggler full length prototype built and tested on operational ring (Fig5) by 2012-13

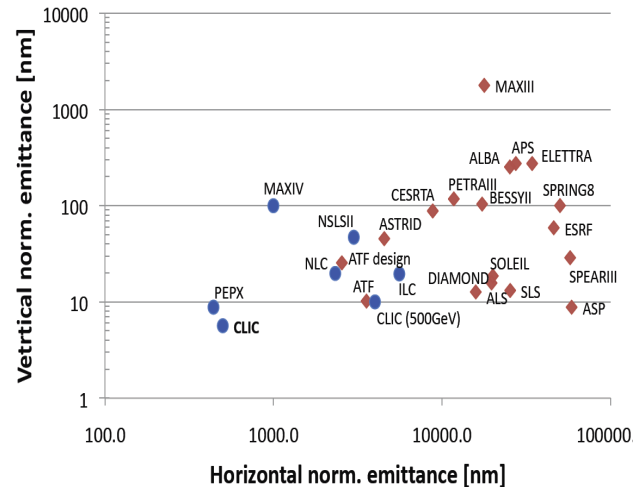

Figure 5: Beam normalized emittances in rings (Operational in red, Projects in blue).

Active Pre-Alignment [21]

Issues: Pre-Alignment of components with 3 microns rms precision and accuracy along a sliding window of 200m

R&D: Overlapping stretched wires (Fig6)) with Wire Positioning Sensors (WPS) tested on dedicated test bench. Adjustment by cam movers and linear actuators with sub-micrometric displacements.

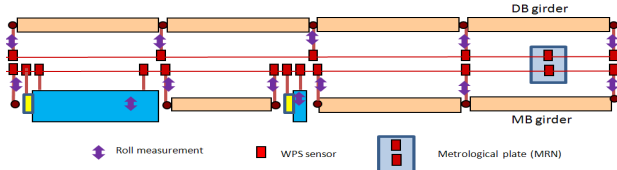

Figure 6: Overlapping stretched wires and WPS.

Achieved performance: Short distance precision achieved in CTF2. 2 microns precision and about 15 microns accuracy over 140 m demonstrated on test bench.

Outlook: Validation on four fully equipped Two Beam modules first in laboratory then by tests with beam in accelerator environment of CLEX/CTF3. Alternative Laser based alignment being investigated.

Stabilisation

Issue: Vertical RMS displacement integrated over whole frequency range lower than 1.5 nm for the main linac quadrupoles and 0.2 nm for the QD0 final doublets.

R&D: Active vibration stabilisation by piezo actuators with two approaches: i) Soft support with elastomeric joint [22], ii) stiff parallel actuator structure with flexural hinges [23]. Both approaches are being tested on test benches with gradually larger quadrupole mock-ups

Achieved performance: 1 nm at 1 Hz (Figure 7) and nano-positioning with 2 nm precision obtained with stiff approach. 0.13 nm at 5 Hz (Figure 8) demonstrated via active ground isolation & structure rejection techniques.

Outlook: vibration stabilisation by end 2010 on test bench equipped with largest quadrupole prototype (2m, 400kg). Future integration into module prototype in test facility.

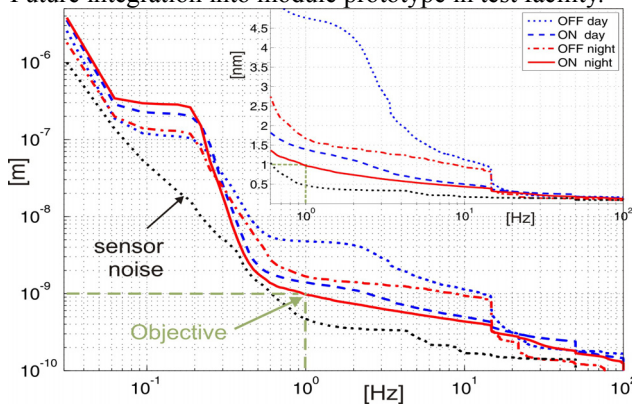

Figure 7: Measured RMS displacement with/without stabilisation (small weight, one degree of freedom) [23].

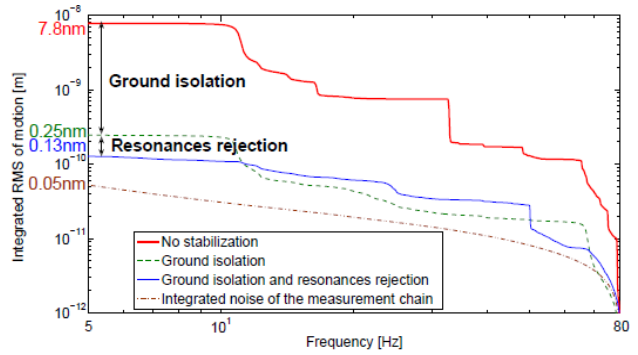

Figure 8: Measured stabilisation via active isolation and structure rejection in laboratory environment [24].

Focusing to nm Beam Sizes

Issues: Vertical beam dimension of 1 nm in high chromaticity 3 TeV Beam Delivery System [25] compared with other design and test facilities in table below:

Project	Status	$\sigma_y^*$ [nm]	$\xi_y$ [ $10^4$ ]
FFTB	Measured	70	1
ATF2	Commissioning	37	1.9
ATF2 ultra-low $\beta$	Proposed	20	7.6
ILC	Design	6	1.5
ILC low power	Alternative	4	3
CLIC	Design	1	6.3

R&D: Compensation of static beam-line imperfections by beam-based alignment and tuning techniques. Dynamic errors mitigated via feedbacks. Validation by simulations bench marked in test facilities, specially an improved ATF2 [26] at KEK with 20 nm vertical beam size and high chromaticity [27] in real accelerator environment.

Achieved performance: 500nm beam size measured in ATF2. 80% of simulation seeds reach 80% of required luminosity. Improvement with combination of IP feedback and beam based alignment being investigated

Outlook: experimental data with beam measurement at relevant IP beam sizes expected in ATF2 before mid 2011

Machine Detector Interface [28]

Issues: Integration of all components especially the final doublet quadrupoles with extremely tight (sub nm) stability in the detector environment and in the context of two detectors with anti-solenoid in push-pull mode.

R&D: Development of a QD0 quadrupole based on hybrid technology of permanent magnets and electromagnetic coils. Concept of QD0 supported from tunnel for better stability. Fast Intra-pulse feedback.

Achieved performances: Permanent magnet QD0 short prototype in construction available early 2011. Concept of feedback and feedforward. Intra-pulse feedback with 37ns time legacy, relaxing required stability by factor 2.

Outlook: Integration and test of QD0 prototype stabilisation on Test stand test. Design of feedback and feed-forward based on real detector environment measurements. Realistic push-pull design (Fig 9).

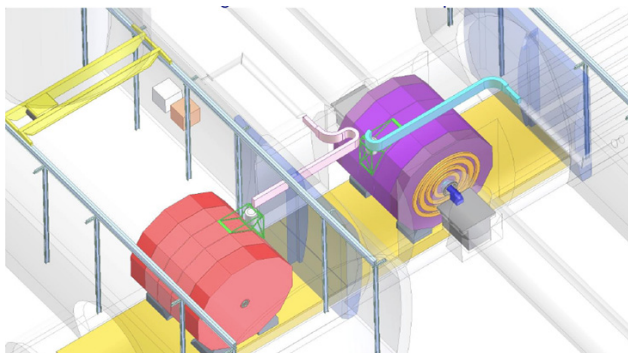

Figure 9: Two detectors in push pull mode.

### *High Beam Power Operation and Machine Protection System (MPS) [29]*

*Issues:* Handling safely i) 13 MW main beam power at 1.5 TeV, ii) 72 MW drive beam power at 2.4 GeV, iii) main beam charge and drive beam charge densities, four orders and two orders above safe beam limit, respectively.

*Achieved:* Concept based on passive & Real Time protection, Beam Interlock System & next Cycle Permit

*R&D:* Beam simulation & material studies. Collimators, Dumps, Sweep diluting kickers

*Outlook:* Beam Interlock System and Next Cycle Permit to be implemented and tested in CTF3.

## CONCLUSION

The CLIC study is developing a novel scheme based on a new technology in order to extend Linear Colliders into the Multi-TeV beam collision energy range. The design of a linear collider at 3 TeV with high luminosity is very promising but requires technological developments above the present state of the art. Following 25 years of R&D, all feasibility issues are being addressed by a world-wide multi-lateral collaboration of volunteer institutes with outstanding results. This effort will be summarised by mid 2011 in a conceptual design report (CDR) documenting the concept of a linear collider in the multi-TeV energy range based on CLIC technology and of all subsystems with a preliminary cost estimate. A technical design phase will then be necessary to optimize the various systems, their large-scale industrialization and their cost before a project can be submitted. CLIC could be built in stages, starting at the lowest energy required by Physics, with successive luminosity and energy upgrades. The exact energy range will be defined following physics requirements derived from the LHC physics results when available with the best balance between performances, technology risk, power consumption and cost.

## ACKNOWLEDGEMENTS

This work is performed by the CLIC/CTF3 collaboration with outstanding contributions and is composed of IHEP, Tsinghua Univ. (China), Aarhus Univ. (Denmark), HIP (Finland), IRFU, LAL, LAPP (France), Karlsruhe Univ. (Germany), Athens, Patras &

Thrace Univ. (Greece), RRCAT (India), LNF (Italy), KEK (Japan), Univ. Oslo (Norway), NCP (Pakistan), BINP, IAP, JINR (Russia), CIEMAT, UPC, IFIC (Spain), Uppsala Univ. (Sweden), ETHZ, PSI (Switzerland), Ankara & Gazi Univ. (Turkey), Cockcroft, Oxford & RHUL of John Adams Institute, RAL (UK), IAP (Ukraine), ANL, JLAB, NWU, SLAC, UCSC-SCIPP (USA) and CERN. It takes advantages of a close and extremely fruitful collaboration with ILC. This paper has benefited from invaluable contributions of numerous CLIC team members.

## REFERENCES

- [1] <http://cern.ch/CLIC-study/Collaborations.htm>.
- [2] S.Myers, "LHC comm. and op.", these proceedings.
- [3] "ICFA Statement on Linear Colliders", 12Aug. 99.
- [4] R. Assmann et al., "Brief history of LEP" Nucl. Phys. Proc. Suppl. 109B (2002) 17–31.
- [5] V.Shiltsev: "Muon accelerator R&D"; Modern Physics Letters A, 'Vol. 25, No. 8 (2010) 567–577.
- [6] SLC: <http://www-sldnt.slac.stanford.edu/alr/slc.htm>.
- [7] "ILC Reference Design Report." August 2007, <http://www.linearcollider.org/cms/?pid=1000437>.
- [8] M.Battaglia&al, "CLIC Physics", CERN-2004-005.
- [9] J. Ellis et al., Nature (London) 409, 431 (2001).
- [10] R.Tomas, "Overview of the CLIC Compact Linear Collider", PRST-A&B 13,01480 (2010).
- [11] CLIC: <http://clic-study.web.cern.ch/CLIC-Study/>.
- [12] LCD: <http://lcd.web.cern.ch/LCD/>.
- [13] G. Geschonke&al, "CTF3 design", CERN/PS 2002-08.
- [14] P.Skowronski, "CLIC feasibility demonstration in CTF3", these proceedings WEPE027.
- [15] Syrathev: "PETS", PAC09, Vancouver, Canada, May 4-8, 2009.
- [16] E.Adli et al., "Experimental results of the CTF3 Test Beam Line", this proceeding.
- [17] A.Grudiev: PRST Accel. Beams 12 (2009) 102001.
- [18] G.Riddone et al: "CLIC Two-Beam Module", EPAC08, Genoa, Italy, 23 - 27 Jun 2008.
- [19] Y.Papaphilippou et al, "CLIC Damping Ring design", these proceedings, WEPE089.
- [20] D.Schulte et al, "beam based alignment in CLIC", PAC09, Vancouver, Canada, May 4-8, 2009.
- [21] <http://clic-alignment.web.cern.ch/clic-alignment/>
- [22] S. Redaelli, " Nanometer Stabilisation in CLIC", PhD thesis, EPFL, Lausanne, 2004.
- [23] K. Artoos et al., "CLIC quadrupole nanometer stabilisation and fine positioning", these proceeding.
- [24] B. Bolzon et al, "CLIC Final Doublets sub-nanometre stabilization", Nanobeam 08, LAPP-TECH-2008-05.
- [25] R. Tomas et al, "Status of the CLIC BDS", PAC09, Vancouver, Canada, May 4-8, 2009.
- [26] P.Bambade et al, Phys. Rev. ST Accel. Beams 13, 042801 (2010).
- [27] D. Angal-Kalinin et al, "ATF2 ultra-low IP betas proposal", these proceedings.
- [28] [http://cern.ch/CLIC-Study/CLIC\\_MDI\\_committee](http://cern.ch/CLIC-Study/CLIC_MDI_committee).
- [29] M.Jonker et al., "The CLIC Machine Protection System", these proceedings.