

STATUS OF THE CONTINUOUS MODE SCAN FOR UNDULATOR BEAMLINES AT BESSY II

A. Balzer, E. Schierle, E. Suljoti, M. Witt, HZB, Berlin, Germany
R. Follath, PSI, Villigen, Switzerland

Continuous Mode – Energy Scans

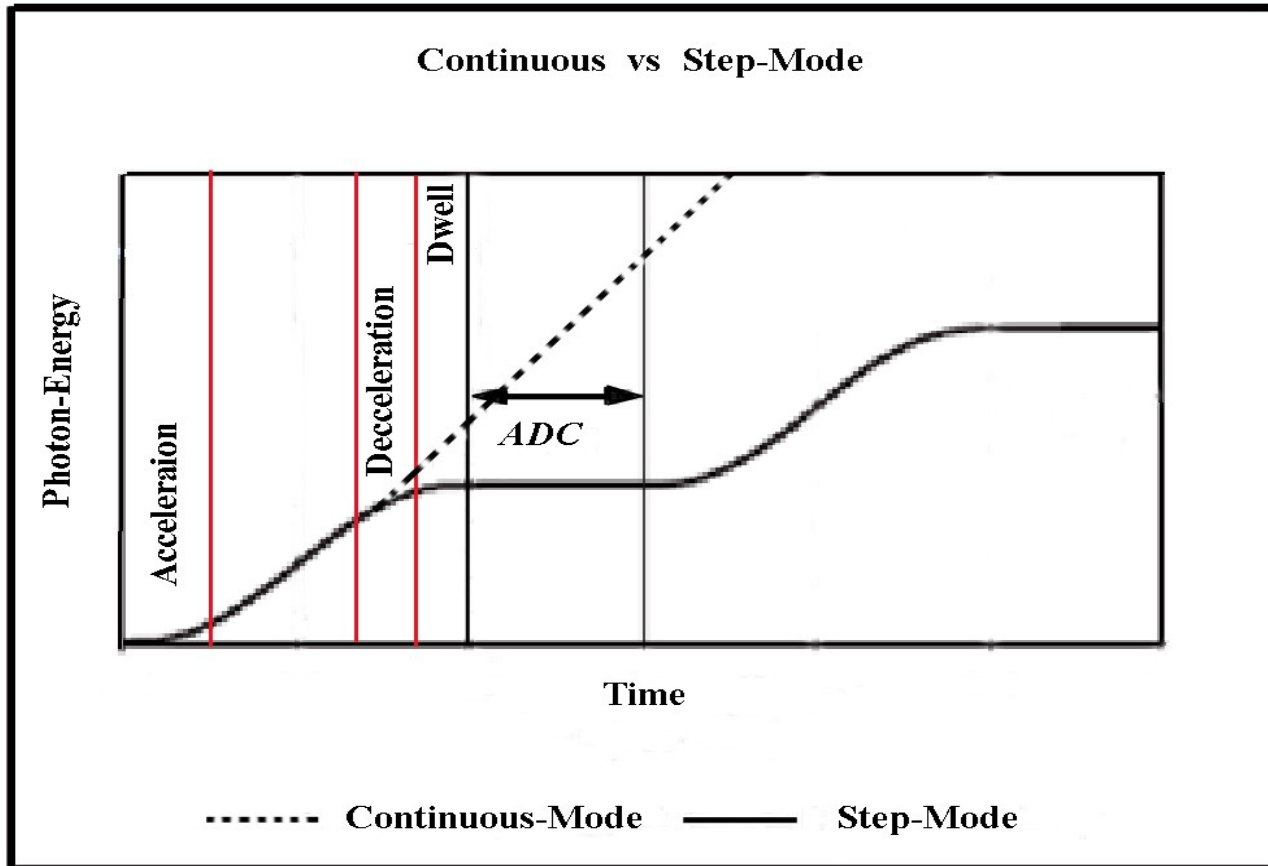

- Mono and ID cover the whole range of a scan in a non-stop coupled motion.
- Depending on application ~5 times faster than step mode.
- Reduced radiation exposure time.
- Mono and ID move separately to intermediate target positions.
- Stable flux for long measurements.
- Dwell and settling time for each move.
- Communication software overhead.

Continuous Mode – History

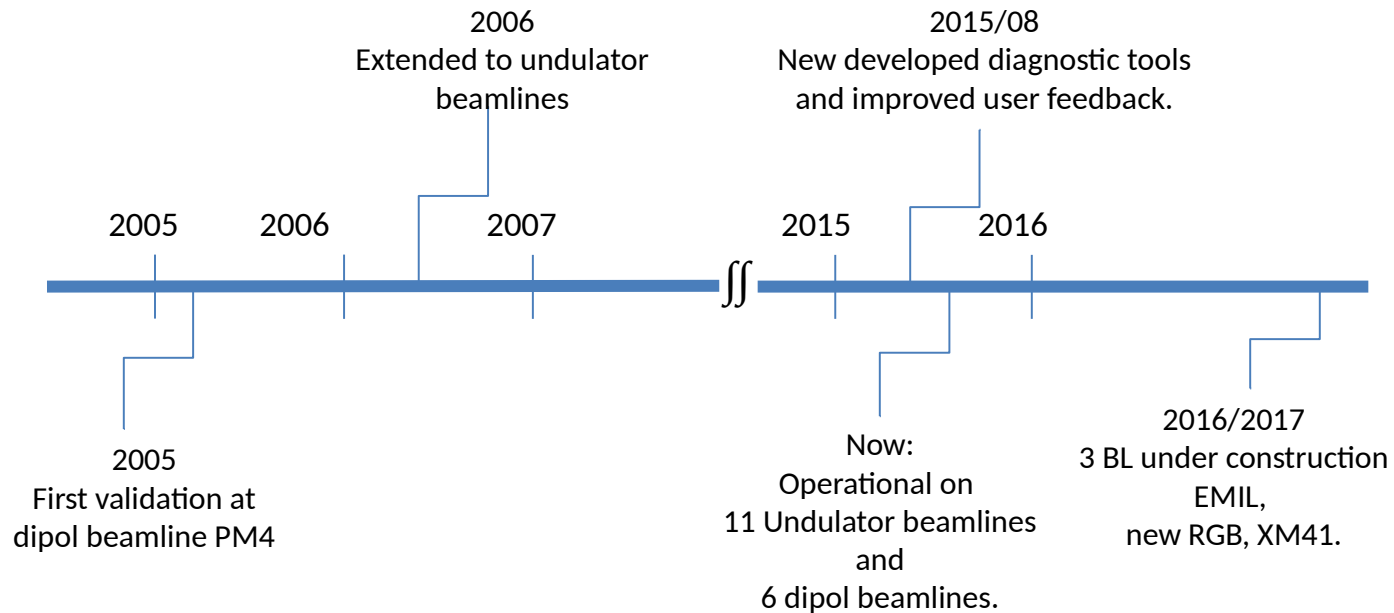

- Continuous mode software first employed 2006.
- 17 beamlines support continuous mode 2015.
- 3 new beamlines under construction requesting continuous mode.

Monochromator Control Program (MCCP) Overview



Continuous Mode – Current Implementation

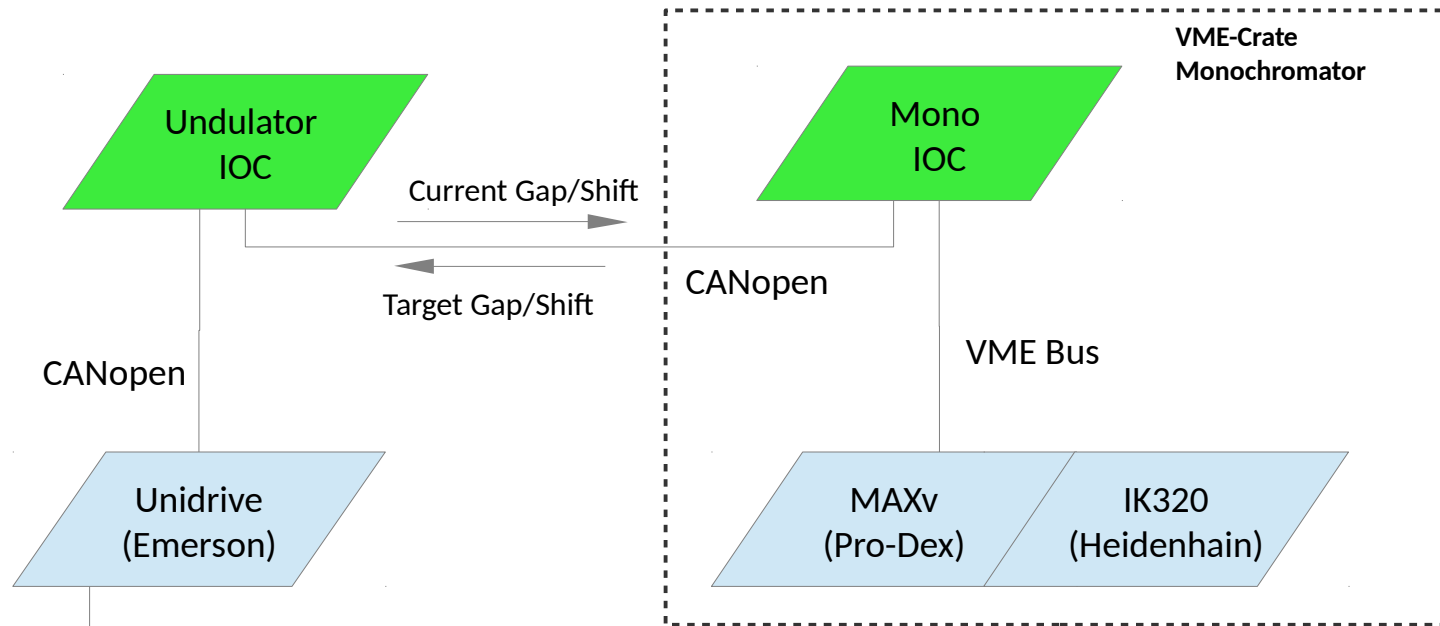

EnDat 2.2

- Position Feedback via CANopen
- Monochromator IOC: MVME162 (Motorola)
VME6/OMS58/MAXv (Pro-Dex)
IK320 (Heidenhain)
- Undulator IOC: MVME 2100 (Motorola)
Unidrive SP (Emerson)

Continuous Mode – Current Implementation

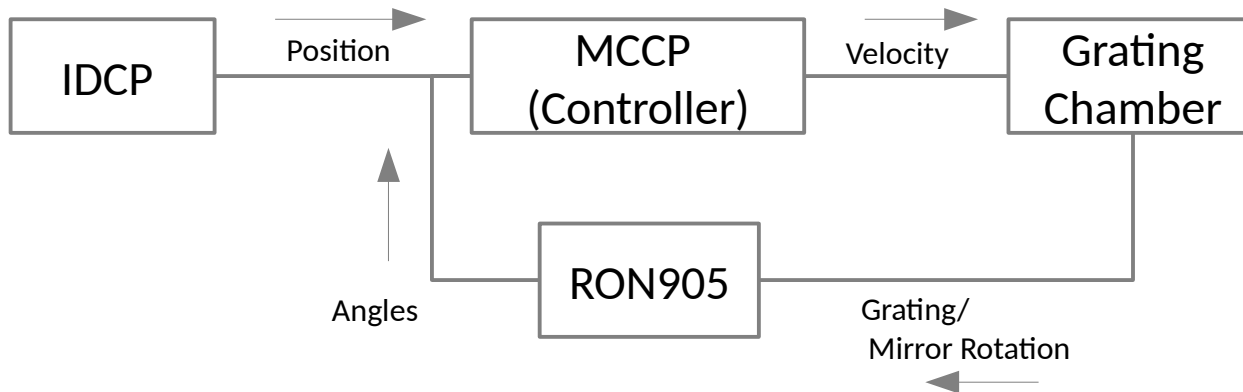

- Monochromator follows motion of undulator gap position.
- Undulator energy calculated from lookup table using up to 3rd order polynomial interpolation or cubic splines.
- Trajectory needed for grating and mirror calculated using grating equation and conditions (fix focus, fix beta, fix theta).
- IK320 counter card and angle encoder RON905 ensure high encoder resolution.

Continuous Mode – Data Flow and Processing

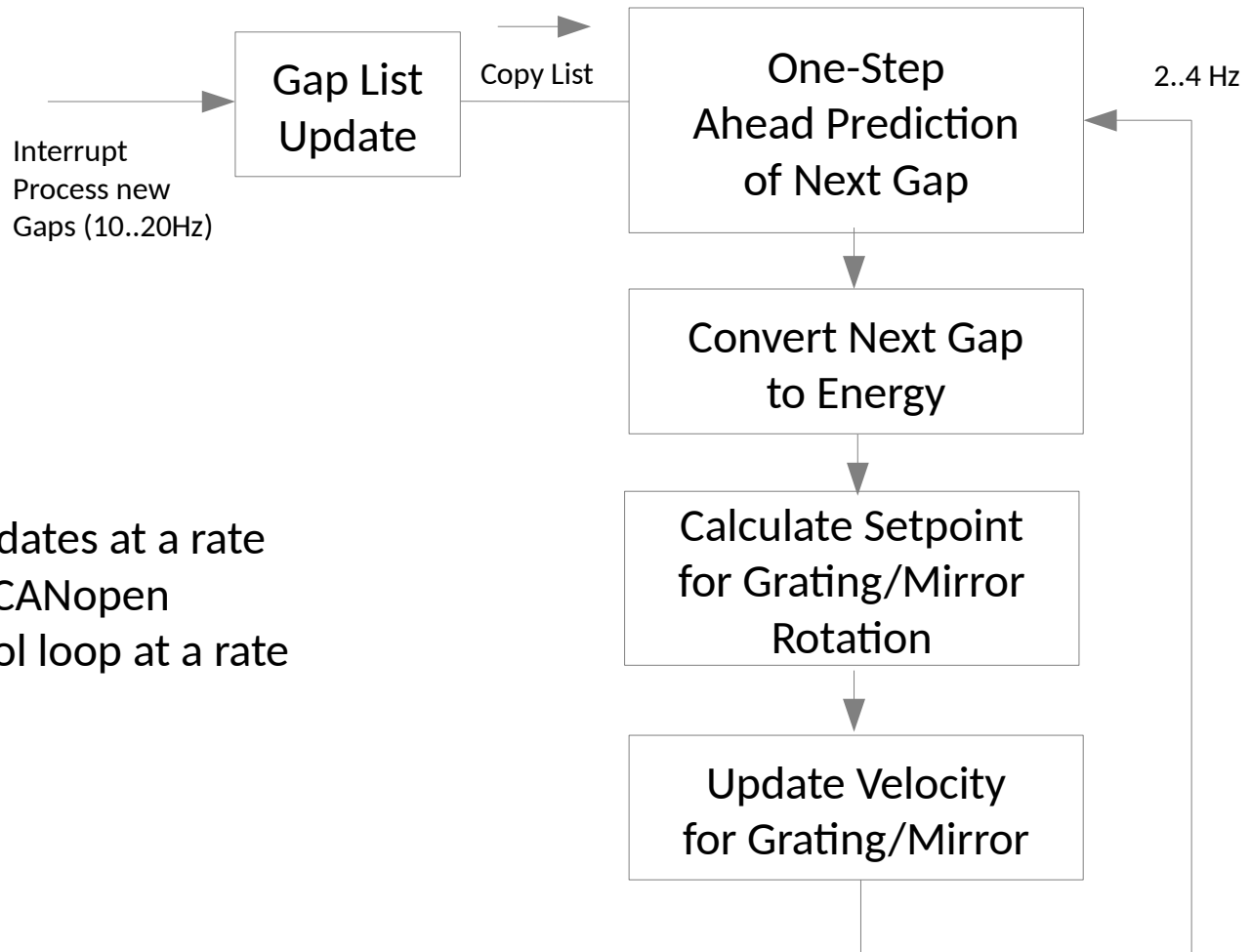

- Gap position updates at a rate of 10..20 Hz via CANopen
- Predictive control loop at a rate of 2..4 Hz

Continuous Mode – (Soft) Limits on Following Error (FE)

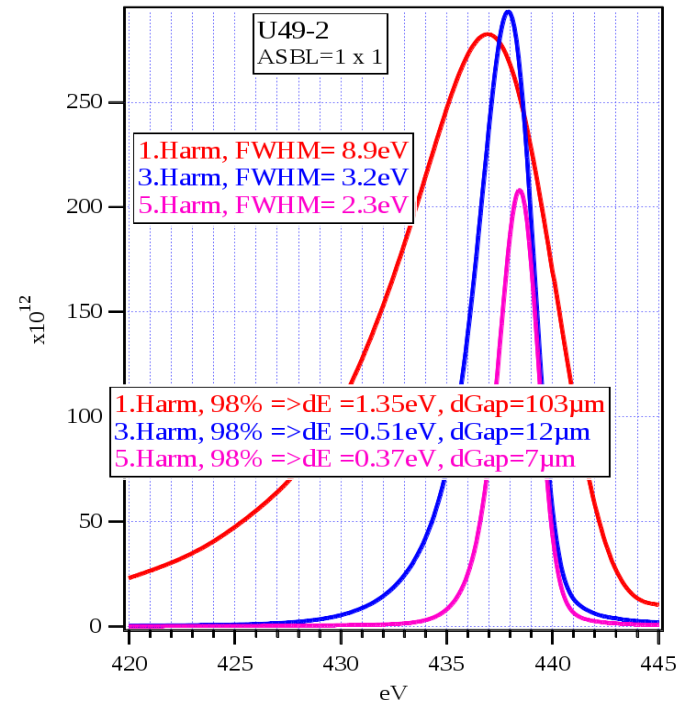
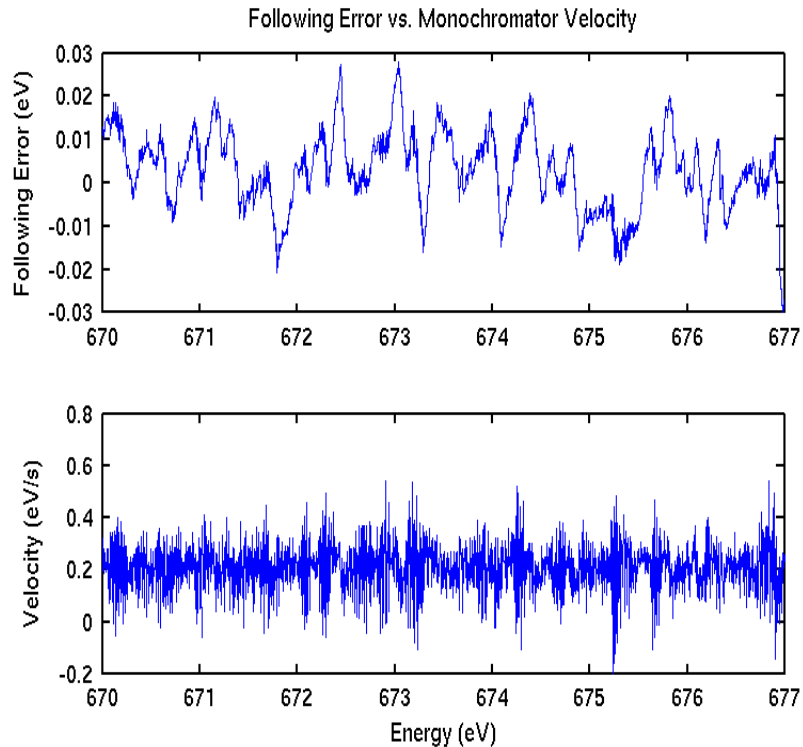

$$\frac{\Delta E_h}{E} \approx \frac{1}{hN}$$

- Intensity modulations < 2% limiting tolerable difference between monochromator energy and undulator energy (FE).
- Undulator bandwidth decreases with higher harmonics.
- Inaccurate undulator lookup tables would have great impact on this limit of the FE.

Continuous Mode – Feedback Module



- EPICS based library designed for RT DAQ
- CM diagnostics plugin
- Interrupt triggered processing
- Two datasets consisting of four data arrays
- Phi, Psi, monochromator energy, undulator energy
- Data alternately copied to EPICS record layer
- Continuously filled by feedback task
- `camonitor` for user feedback
- Evaluation of the data after the scan

Continuous Mode – RT Position Data Acquisition and Scheduling

- Data acquisition rate up to ~ 4 kHz.
- Depending on data processing by the feedback plugin.
- Hardware triggered after data processing.

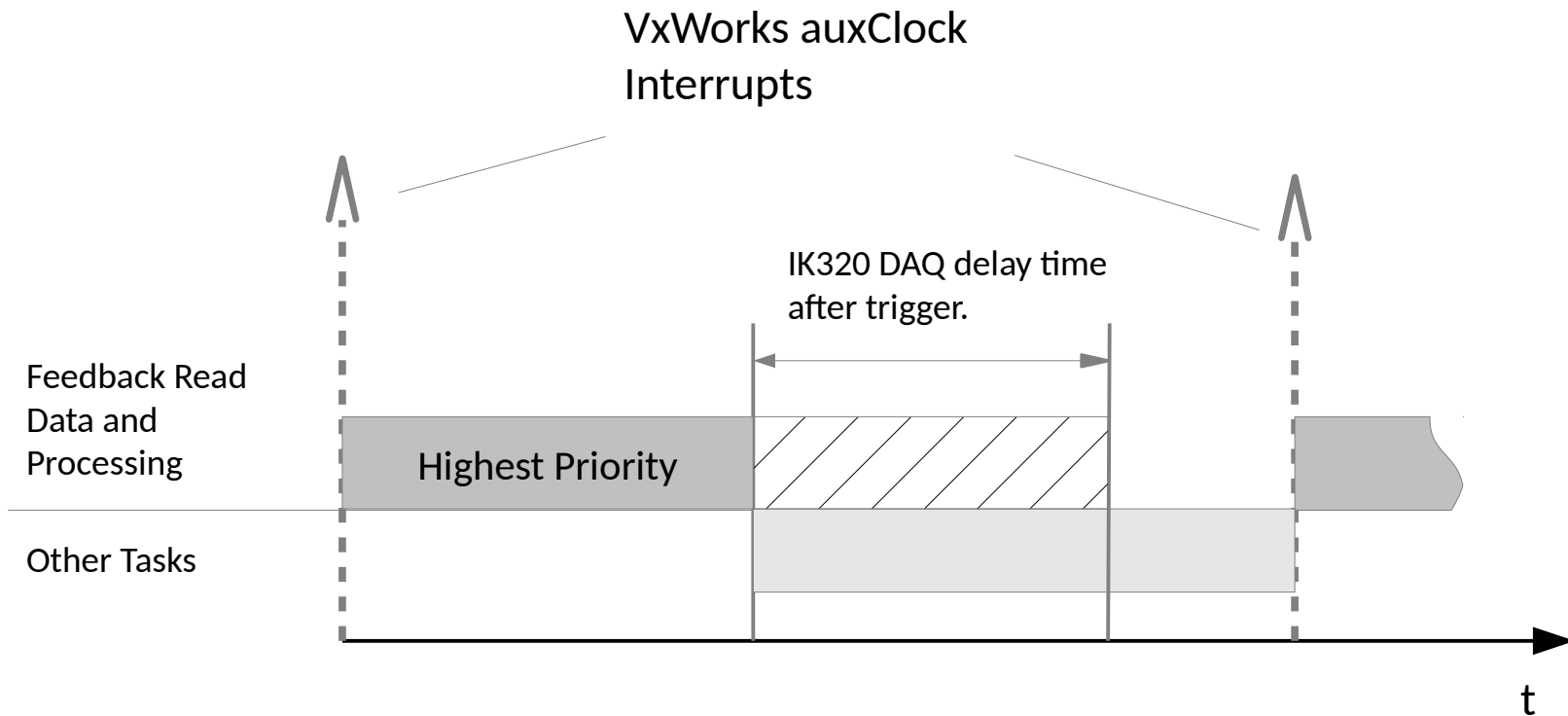

Continuous mode – Diagnostics Applications

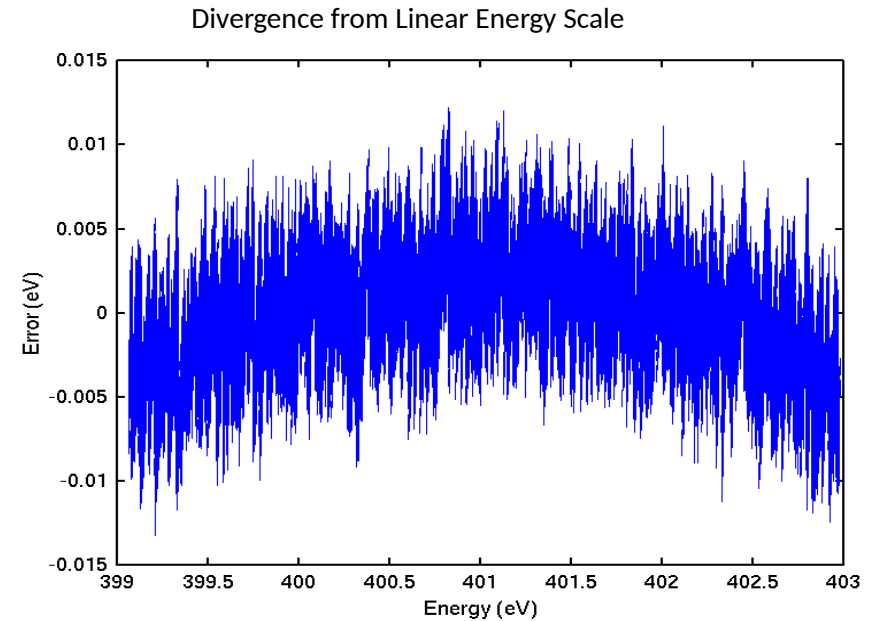
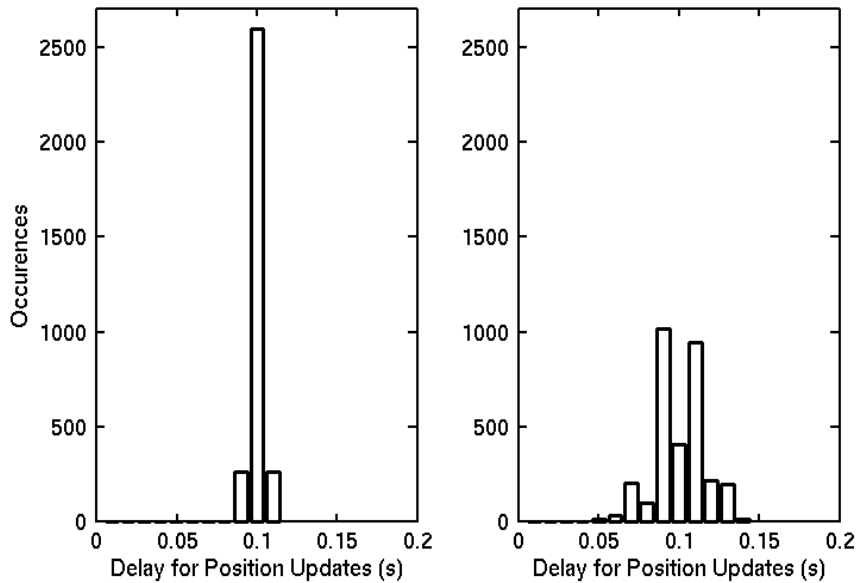

- CAN Jitter has big impact on stability.
- Needed for further diagnostics, tuning, and optimization procedures.
- Correction of energy scale by correlating feedback data with experimental data.
- Complex filters on feedback data to remove disturbances.

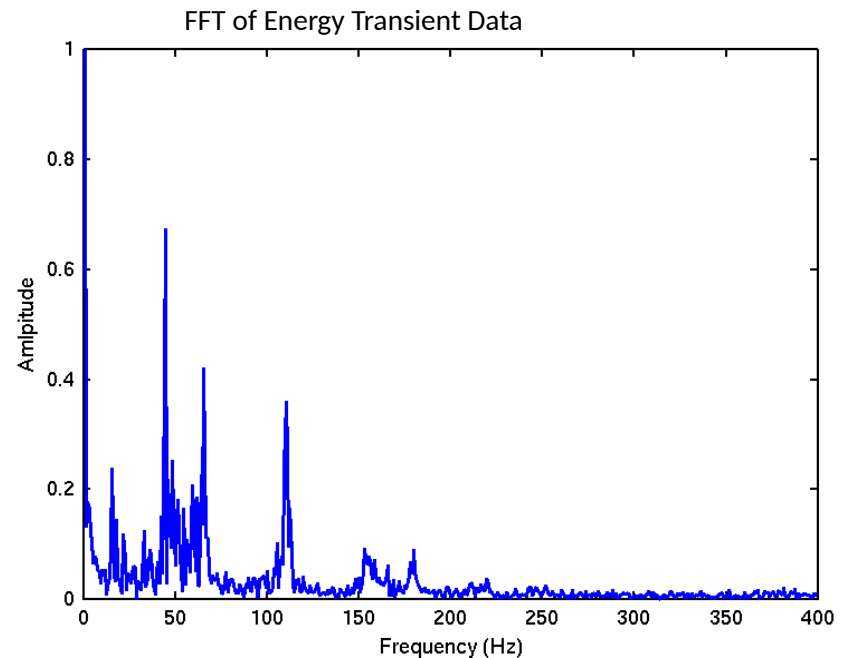

Continuous Mode – Experimental Validation

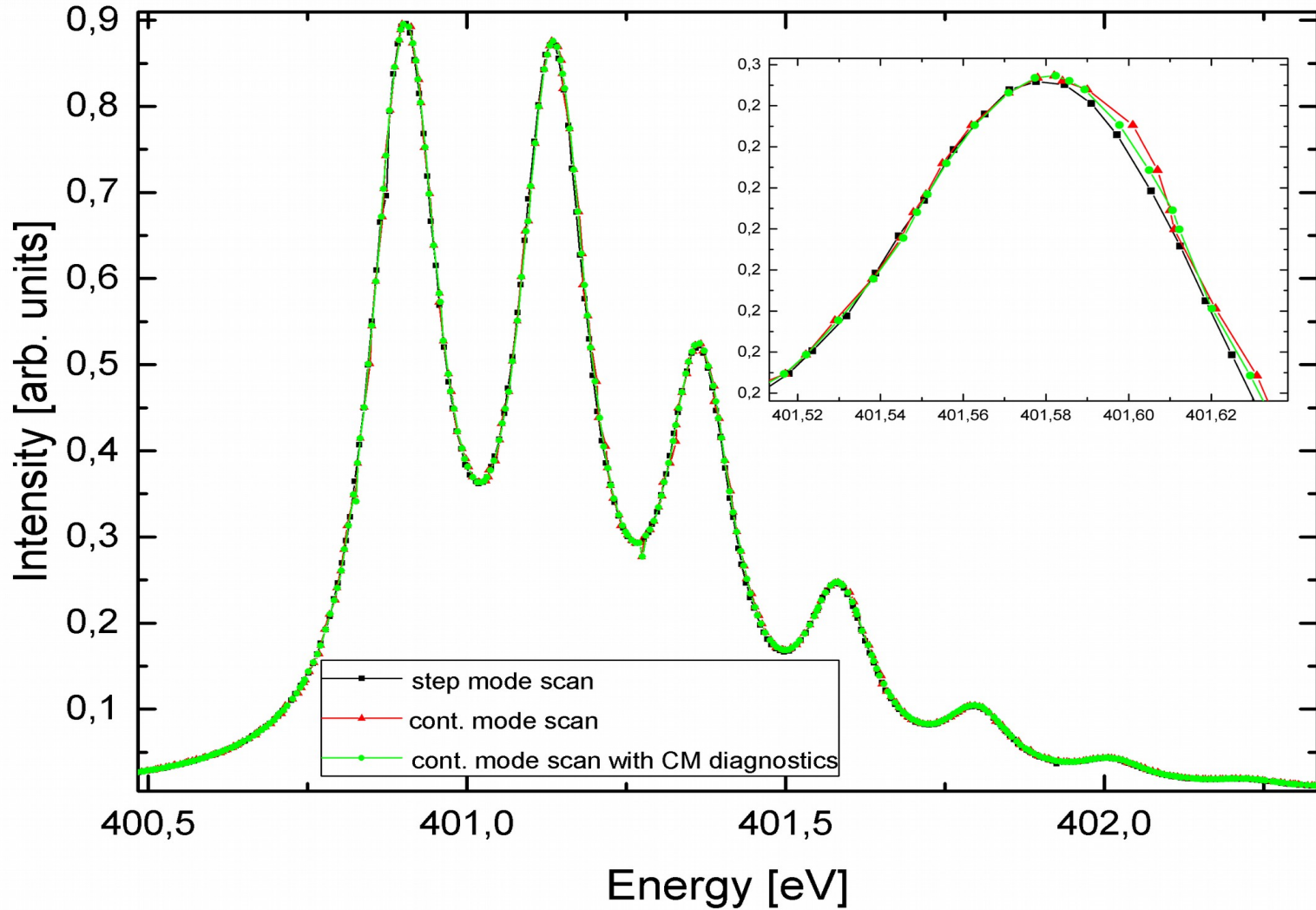

- Molecular Nitrogen absorption spectra taken.
- Step mode vs. continuous mode at a velocity of 0.1 eV/s.
- Monochromator energy feedback data had been taken at a rate of 800 Hz.

Continuous Mode – Limitations

- The undulator moves gap with constant velocity.
- Fixed shift.
- Shift is at optimum for elliptical polarisation.
- Direction reversal prevented by monochromator software.

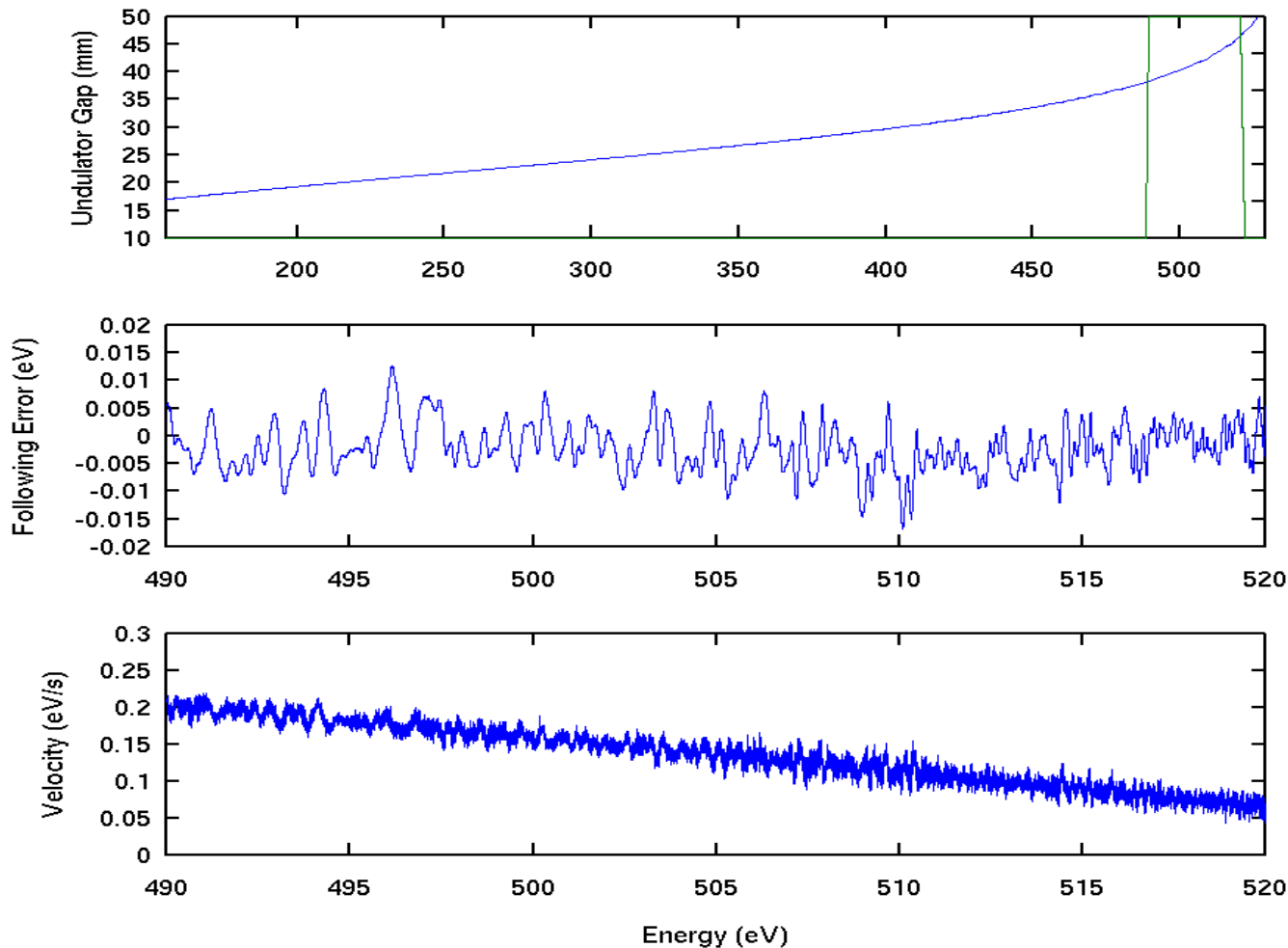

Continuous Mode – Possible Implementation for EMIL

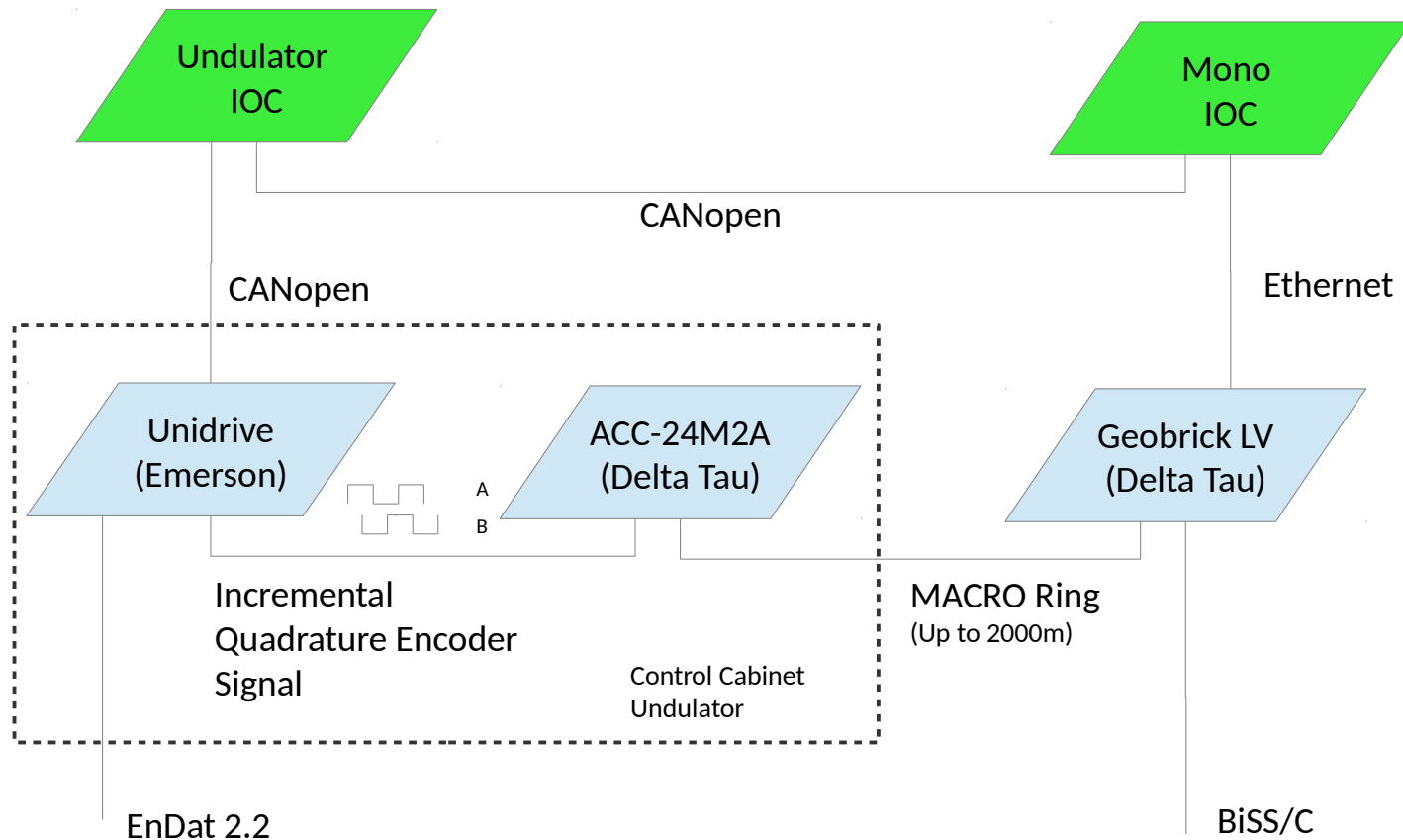

- Motion controller connected via non deterministic Ethernet to IOC.
- Hard real time position feedback via encoder signal from undulator to the motion controller of monochromator.
- Slow control providing lookup tables from monochromator IOC.
- Generated smooth output to monochromator stepper drives using splined moves on motion controller.

Continuous Mode – Conclusions

- A stable and robust control scheme running on 17 beamlines.
- Following error within the limits imposed by higher undulator harmonics ensuring flux modulation $< 2\%$.
- Energy scans possible over the whole energy range of ID-Harmonic
- Monochromator Modi are preserved (e.g fixed focus, fixed beta, fixed theta)
- Diagnostic tools essential for further development.
- Data acquisition at a rate up to 1 kHz for monochromator energy and axes positions offered to users.
- Deterministic communication between monochromator and undulator needed for current implementation.
- New control scheme needed for new beamlines with hardware connected via non deterministic Ethernet.