

Nonlinear System Identification of Superconducting Magnets of RHIC at BNL

P. Chitnis, K. A. Brown
MOM310 (Systems Engineering & Project Management)

Presenter: Prachi Chitnis

PhD Student
Stony Brook University, NY
Brookhaven National Laboratory, NY

Superconducting Magnet

1

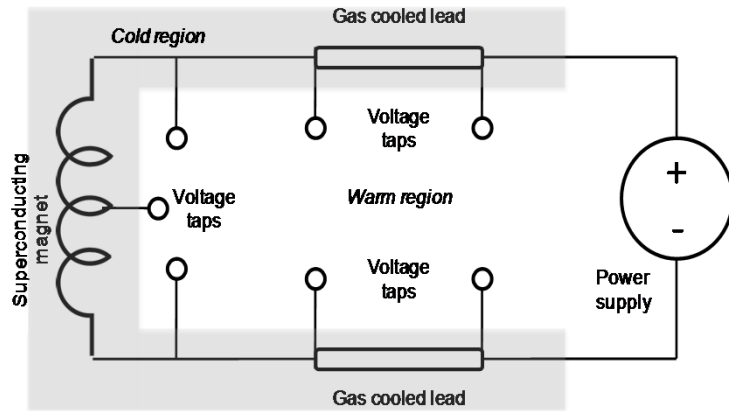

Voltage Tap Circuit

2

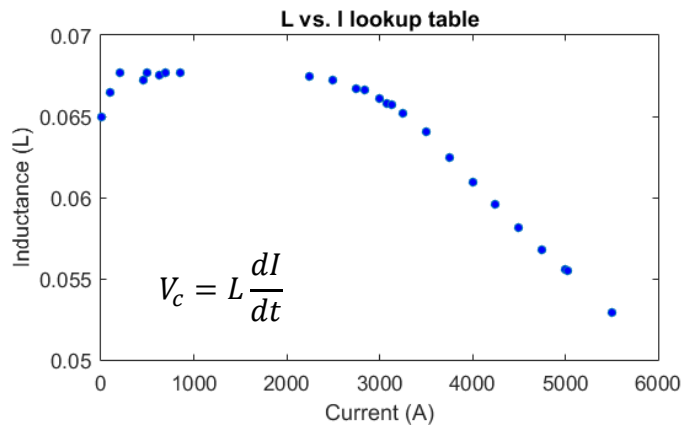

Manually Calibrated Inductance Table

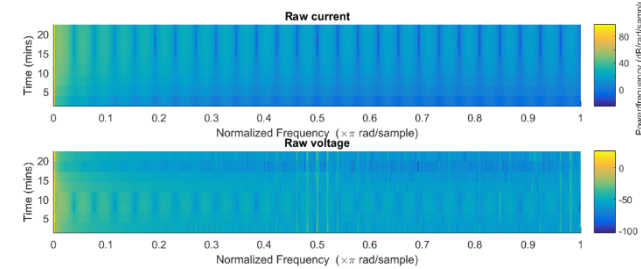

3

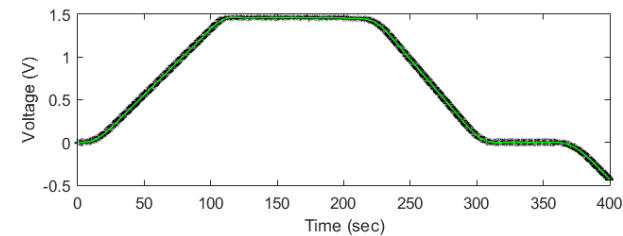
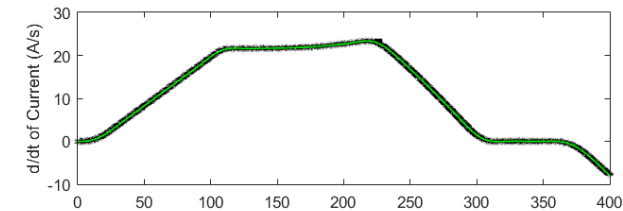
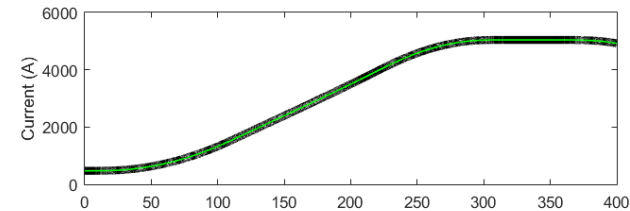

4

Spectrograms and Filtering of signals

System Identification

1

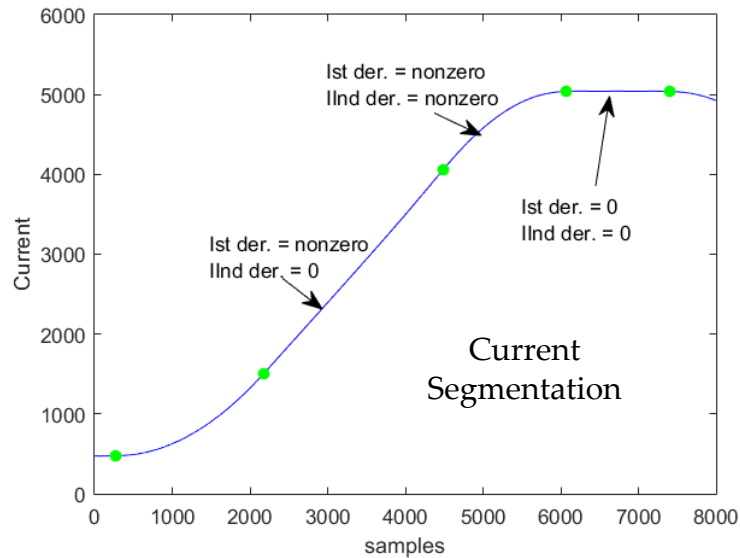

2

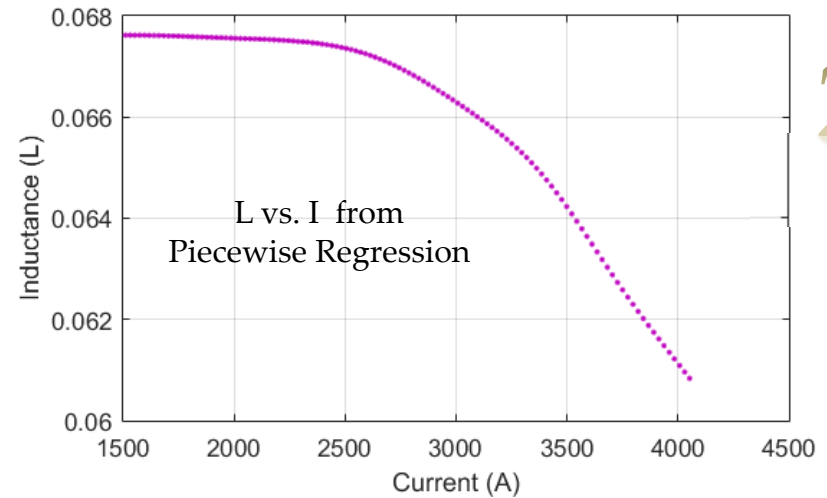

3

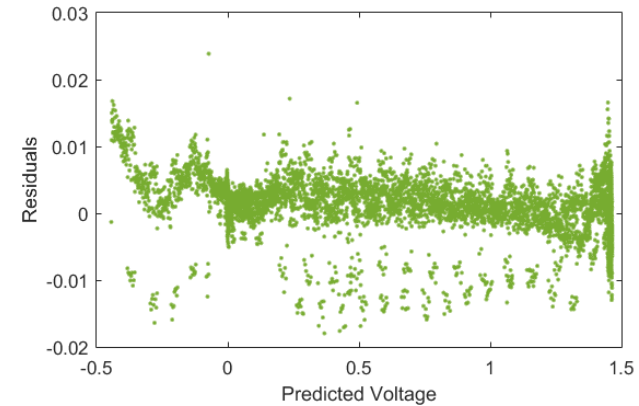
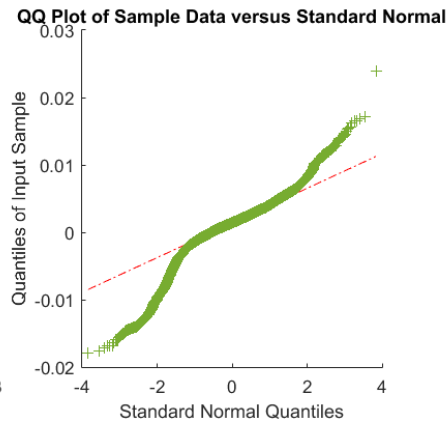
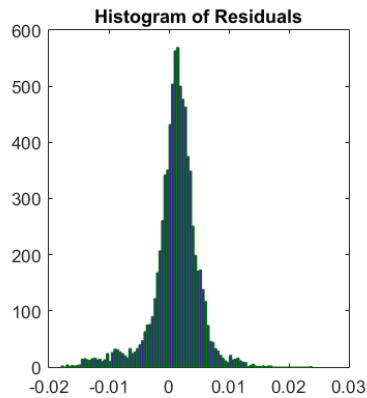

Residual Analysis

Field Test

