

TPS BOOSTER TUNE MEASUREMENT SYSTEM

P. C. Chiu, K. H. Hu, H. P. Hsueh, Y. S. Cheng, Demi Lee, K. T. Hsu
NSRRC, Hsinchu 30076, Taiwan

Abstract

The Taiwan Photon Source (TPS) is a state-of-the-art synchrotron radiation facility featuring ultra-high photon brightness [1]. Its Booster has 6 FODO cells which include 7 BD dipoles with 1.6 m long and 2 BH dipoles with 0.8 m long in each cell. After magnetization of stainless steel vacuum chamber of the booster were identified and then dismantled, annealed, and re-installed, the electron beam energy of the TPS booster ring has ramped to 3 GeV in a week. The booster tune correction during ramping is one of the main reasons why the booster commissioning progress so fast. This report will be summarized the booster tune monitor system.

INTRODUCTION

The TPS is a state-of-the-art synchrotron radiation facility featuring ultra-high photon brightness with low emittance. The TPS accelerator complex consists of a 150 MeV S-band linac, linac to booster transfer line (LTB), 0.15–3 GeV booster synchrotron, booster to storage ring transfer line (BTS), and 3 GeV storage ring. The booster has 6 FODO cells and its circumference is 496.8 meter; the storage ring's circumference is 518.4 meters with 24 DBA lattice and 6-fold symmetry. The booster and the storage ring share the same tunnel in a concentric fashion. During 4 years of construction period, civil constructions had been completed in early 2013. The accelerator installation then had taken another one year.

At September 2014, booster tune measurement commissioning had committed with beam commissioning. First-turn was easily obtained by beam steering and then multi-turn was also observed after optimization of Linac and transfer line. However, the beam could not be stored. After some hardware improvement such as power supply tuning, chamber and magnet re-alignment, kicker and septum improving and etc., the key setback was finally found on November 12: the pipes had a relative high permeability (ranging from 1.2 to 2.0) induced from the lack of proper annealing process. These un-annealed chambers were uninstalled and treated in vacuum oven up to 1050 °C, and then re-installed. Booster then had stored beam in DC mode and ramped to 3 GeV successfully at December 16 2014 after several times of tune compensation. The tune measurement system provides precise tune measurement to correct tune variation during energy ramping and avoid across the resonant line which would cause a lot of beam loss. This report will summarize the infrastructure of booster tune measurement system measurement results and tune compensation during TPS booster commissioning.

TUNE MONITOR SETUP

Originally during booster commissioning beginning in Sep. 2014, the magnetic shakers where two multi-turn coils are mounted on vacuum chamber in horizontal and vertical plane are applied to excite beam. The kickers with 50Ω terminated load have calibration factor of 3 mG/A and are driven by a 50W amplifiers. Later, the stripline electrodes are adopted to replace magnet shakers on the booster synchrotron considering more power strength to excite beam. The TBT data provided by BPM electronics would be acquired to extract tune by FFT. Agilent arbitrary signal generator would provide band-limited, strength-adjustable excite signal. The functional block diagram of this new tune monitor system is shown in Fig.1. Figure 2 shows the stripline kicker installed in June 2015 to provide more efficient power to excite beam.

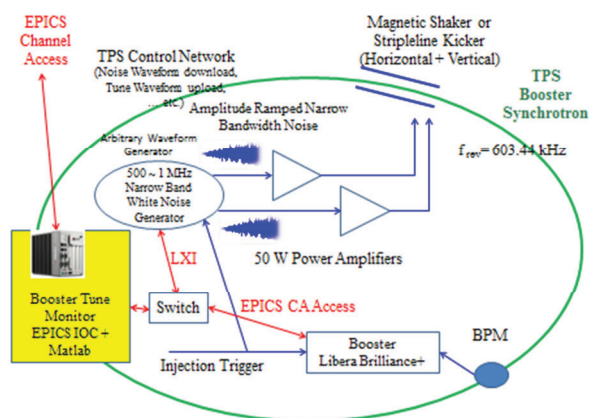

Figure 1: Functional block diagram of the tune monitor for TPS booster.

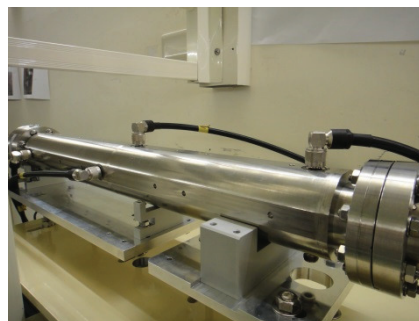

Figure 2: Stripline kickers installed in June 2015.

Figure 3 shows the booster tune measurement GUI. The spectrogram of the horizontal and vertical of BPM turn-by-turn data could identify tune variation clearly. Peak identification from the spectrogram could extract the

varying tunes during one ramping cycle. Excitation waveform would be generated from white noise with limited bandwidth and strength could be adjusted as energy increased. The generated waveform would be load to signal generator via EPICS channel access.

Besides, the reproduction of ramping power-supplies stability was critical for it could affect the working point and injection efficiency at 150 MeV at the beginning. The real-time injection tune display is also provided for monitoring as Fig. 4 shown.

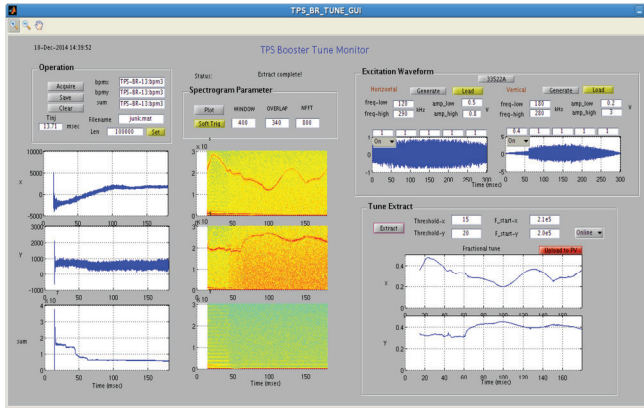

Figure 3: Tune measurement GUI during Booster ramping. Excitation waveform could be set to the proper strength and spectrum.

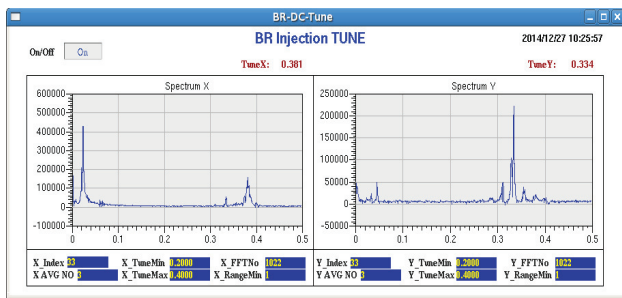

Figure 4: Injection tune extracted from BPM TBT data at injection time.

TUNE MEASUREMENT AND COMPENSATION DURING BOOSTER COMMISSIONING

After chamber demagnetized, we had a stored beam soon after the RF system was activated. Then the first test of energy ramping at AC mode was found that the beam loss occurred when beam ramping to 2.3 GeV as Fig. 4 shown because the vertical tune across 1/3 the resonance line. After tunes compensation scheme applied during ramping, a 3 GeV beam was attained in two days.

The tune variation was as large as 0.22 for horizontal and 0.1 for vertical as Fig. 6 (a) shown. The working points across the resonance line would cause beam loss and decrease the injection efficiency. It could be inferred that reference waveform generated from the measured I-B table provide by the magnet lab could be deviated from

the actual machine. To improve the injection efficiency, Q1 and Q2 are chosen and measured the tune response for tune compensation. After tune correction, horizontal and vertical tune variations are both reduced to 0.05 as Fig. 6(b) shown.



Figure 5: The beam loss occurred when beam ramping to 2.3 GeV observed on the first day of booster AC mode test.

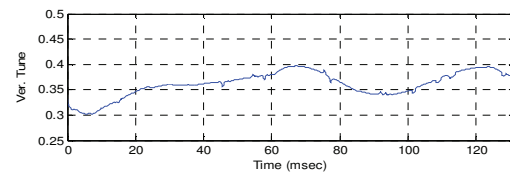
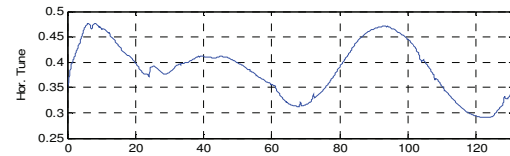

(a)

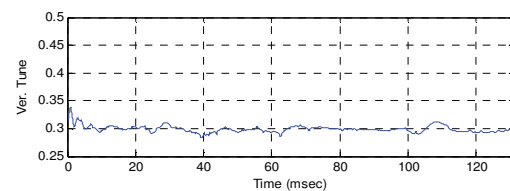
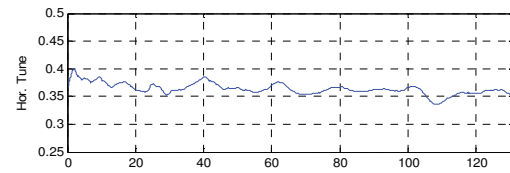

(b)

Figure 6: (a) Tune variation during ramping before tune compensation. Horizontal tune variation was as large as 0.22; vertical tune variation was 0.1. (b) Horizontal and vertical tune variation are both reduced to 0.05 after tune compensation.

BPM TDP AND DDC TBT DATA FOR TUNE MEASUREMENT

DDC (Digital Down Converter) and TDP (Time Domain Processing) Turn-by-turn data are both provided by BPM electronics and the resolution could achieve around 150 μm at 0.5 mA. To use TDP properly, phase offset and mask window should be set correctly [1]. Both of these two TBT data chains could be applied to extract tune. Nevertheless, compared to DDC, TDP could well resolve beam loss status and tune extraction especially in lower beam current or smaller beam motion. It is due to clear and no smear TBT data as Fig. 7 which shows the spectrogram of DDC and TDP data respectively.

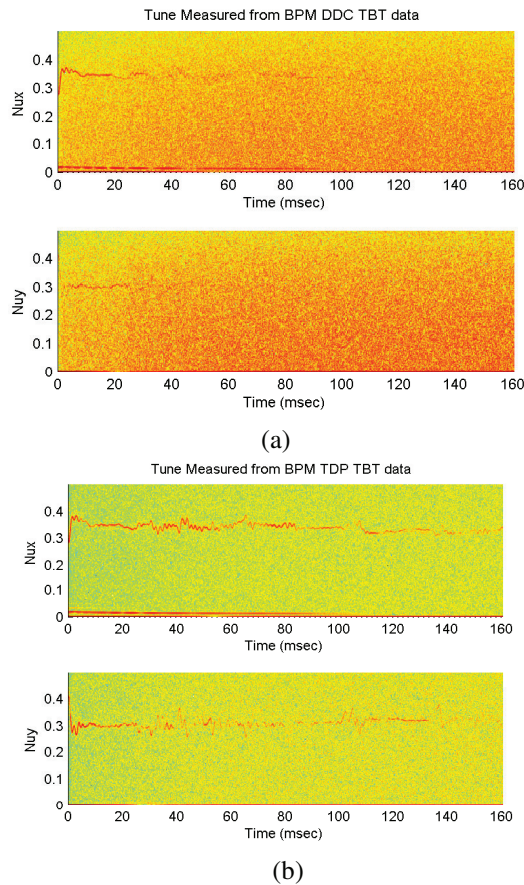

Figure 7: (a) Tune extracted from BPM DDC TBT data during booster ramping (b) Tune extracted from BPM TDP TBT data. TDP had better signal qualities than DDC due to its clear and no smear TBT data.

BOOSTER TUNE STABILITY

Initially, the booster beam current was not stable. It was found that one of the reasons was the stability/reproducibility of booster main power supply not good enough, especially at lower current. Figure 8 shows tune shifts for different injection. At lower energy, the tune reproducibility is worse than high energy. It is because quadruple to dipole relative err would affect tune and when tune drift to the improper working point, it

would have lower beam current. Figure 8 shows the variations of QF to Dipole err, injection tune and beam current. After stability of power supply improved from 0.5% to 0.2%, stability of beam current was also improved [2].

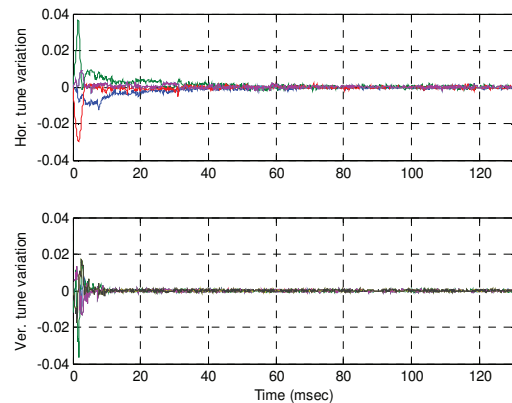

Figure 8: The tune reproducibility observed from 10 times injection. The reproducibility becomes better as energy increased for the reproducibility of power supply also becomes better as current increased.

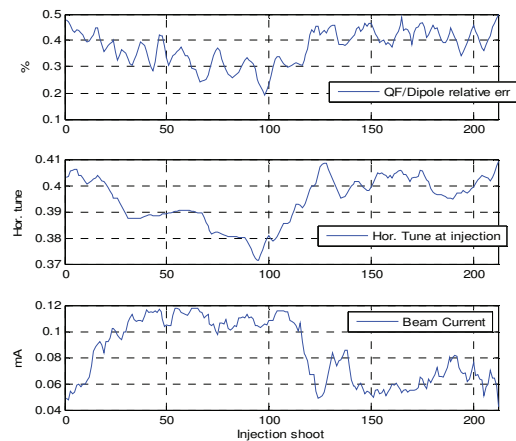

Figure 9: The variations of QF to Dipole relative err, tune and beam current.

SUMMARY

In this report, we summarized the TPS booster tune measurement system and perform tune compensation to reduce tune variation and improve injection efficiency.

REFERENCES

[1] TPS Design Handbook, version 16, June 2009.
 [2] H. J. Tsai et al., "Hardware Improvements and Beam Commissioning of the Booster Ring in Taiwan Photon Source", IPAC'15, Richmond, VA, USA, May 2015.